



NR.1
GROOTHANDEL IN
PLINTEN

PLINTENENPROFIELENCENTRALE.NL

EN NOG

15.999

ANDERE PRODUCTEN



GRAAG GEBRACHT

INHOUD

| | | |
|-----|---------------|-----|
| 1. | DEKVLOEREN | 19 |
| 2. | ONDERVLOEREN | 29 |
| 3. | LIJMEN & KIT | 35 |
| 4. | VLOEREN | 43 |
| 5. | SCHUREN | 89 |
| 6. | OLIE & LAK | 95 |
| 7. | RANDAFWERKING | 107 |
| 8. | ONDERHOUD | 137 |
| 9. | GEREEDSCHAP | 151 |
| 10. | TRAPRENOVATIE | 181 |





LAAT JE INSPIREREN

**EEN HANDIGE CATALOGUS VOOR
IN DE BUS EN BIJ IEDERE KLUS.**

NEEM EVEN DE TIJD, BLADER EN
ONTDEK WAT PPC TE BIEDEN HEEFT!



Met onze overzichtelijke webshop heb je altijd en overal ons zeer uitgebreide assortiment bij de hand. Alles wat je nodig hebt, gemakkelijk gevonden en besteld. Toch is onze catalogus handig en een mooie aanvulling op de complete service die wij nastreven. Het biedt je de mogelijkheid om samen met je klant door onze artikelen te bladeren. In de catalogus tref je dan ook een mooie selectie van de meest gevraagde producten, inclusief afbeeldingen.



PPC IN HET KORT

PPC, zoals Plinten & Profielen Centrale vaak genoemd wordt, werd in 1999 opgericht door Drees Klaassen. Wat begon als een eenmansbedrijf in randafwerking is uitgegroeid tot de flexibele totaalleverancier voor parketteurs en andere vloerspecialisten. PPC levert uitsluitend aan bedrijven.

Bij het hoofdkantoor in Wijk bij Duurstede staan alle vloeren van hout, laminaat en PVC, randafwerking, en producten voor installatie, afwerking en onderhoud op voorraad. Daarnaast zijn er vestigingen in Amsterdam, Den Haag, Eindhoven, Groningen en Nieuwegein waar de belangrijkste artikelen ook uit voorraad leverbaar zijn. Broer en zus Peter en Lisa Klaassen vormen sinds juli 2015 de directie van PPC, een (h)echt familiebedrijf. Samen met het 6 koppig managementteam streven zij naar continuïteit en bieden momenteel werk aan ruim 200 medewerkers.

Managementteam PPC foto v.l.n.r.

Danny Benschop, Niels Aarnoudse, Kevin Kroon, Ronald Slagmolen, Lisa Klaassen, Harold de Graaf, Peter Klaassen, Sander van de Weert.

MISSIE

Wij staan altijd voor onze **klanten** klaar. Het hele jaar door doen wij alles voor het **gemak** en streven continue naar het meest complete en kwalitatief hoogstaande **assortiment**. Altijd in huis en makkelijk beschikbaar voor de vloerspecialist.

VISIE

Bij PPC streven we er als **één team** naar om voor elke vloerspecialist de meest toonaangevende, inspirerende en innoverende partner te zijn. Zowel in **klantbeleving, processen, voorraad als service**.



VAKKUNDIGE EN KLANTVRIENDELIJKE MEDEWERKERS

Ons team bestaat uit gedreven en vakkundige mensen. Wat wij doen, doen wij als één team voor het gemak van onze klant. We geven advies met verstand van zaken waarmee je het maximale uit onze producten kan halen. Daarnaast hebben we klanttevredenheid hoog in het vaandel staan.

Onze vakkennis delen wij ook in de vorm van cursussen en trainingen, ondergebracht in de PPC Academy (zie pagina 17). De PPC Academy is ons speciale kennis- en opleidingscentrum. De plek waar jij jouw vak- en productkennis naar een hoger niveau kunt tillen.



**BREED EN INNOVATIEF
ASSORTIMENT**



**GRAAG
GEBRACHT!**

**VAKKUNDIGE EN KLANTVRIENDELIJKE
MEDEWERKERS**



**MAKKELIJK
AFGEHAALD**

PPC
ALLES VOOR DE
PARKETTEUR



**GUNSTIGE
RETOURREGELING**



**MET GROOT GEMAK
BESTELD**



GRAAG GEBRACHT

EIGEN WAGENPARK MET EIGEN CHAUFFEURS



Als klant van PPC ben je verzekerd van de beste service, verzorgd door mensen die weten waar ze het over hebben. Met ons eigen wagenpark en onze eigen chauffeurs bezorgen wij de bestelde producten graag op de aangegeven locatie!

Zo hebben we verschillende bezorgopties. Twee vaste bezorgdagen per week, zónder vrachtkosten. Voor deze leveringen geldt dat je op de vaste bezorgdag, bijna tot op de minuut nauwkeurig, kan zien hoe laat de bestelling wordt geleverd. Of wil je liever dat de bestelde materialen direct bij je klant worden afgeleverd? Ook dat is geen probleem! Dit noemen wij de PPC-locatielevering. Ben je op het laatste moment iets vergeten? Of heb je net niet genoeg materiaal? Als het echt snel moet, bieden we met de PPC Express Service uitkomst. Bel vóór 11 uur en wij bezorgen het dezelfde dag nog op je vaste afleveradres of je werkadres, ook al is het niet je vaste leverdag! Met één belletje is het dus geregeld.

Je kunt uiteraard je bestelde producten ook ophalen in één van onze filialen, als je dat beter uitkomt. Kopje koffie erbij en de start van je dag is compleet! Bestel je kleinere producten zoals onderhoudsproducten of samples en wil je dit direct afgeleverd hebben bij je/jou klant? Dan worden deze ingepakt door PPC en bezorgt door PostNL. Vóór 15:00 uur besteld, is de volgende dag geleverd.



MET GROOT GEMAK BESTELD

OOK HANDIG
IN DE WEBSHOP



Wij vinden het belangrijk dat onze klanten altijd met groot gemak in de webshop kunnen bestellen. Daar doen wij alles aan! Dag in dag uit hebben we een duidelijke focus op het vergroten van het gebruiksgemak. Of het nu gaat om complete productinformatie, locatielevering of handige zoektools, alles staat bij ons in het teken van gemak. Zo maak je makkelijk een juiste keuze.

Bij alle artikelen vind je uitgebreide informatie, productbladen en veiligheidsinformatiebladen. Als je meer informatie wil, kun je natuurlijk altijd je vertegenwoordiger contacteren, bellen naar de binnendienst of even langskomen bij een van onze 6 locaties.

Onze mensen voorzien je graag van de juiste informatie.



Zoek, vind en bestel via de slimme tools, zoals: ondervloerenzoeker, plintenzoeker, RoomDesigner en de traprenovatie besteltool



Bestel vanuit de favorietenlijsten, ordergeschiedenis of snel bestellen



Actuele beschikbaarheid van producten weergegeven



Productinformatie en veiligheidsbladen altijd en overal beschikbaar



Overzicht van alle lopende orders en facturen via jouw persoonlijke accountpagina



Kies bij de bestelling voor afhalen of bezorgen



Via onze website is, op de dag van de levering vanaf 08:00 uur in de ochtend, zichtbaar hoe laat de chauffeur verwacht bij je te zijn



Bestellingen geplaatst voor 21:30 uur leveren de eerstvolgende vaste bezorgdag



PPC Academy trainingsaanbod

Check de actiepagina voor actuele aanbiedingen en andere acties

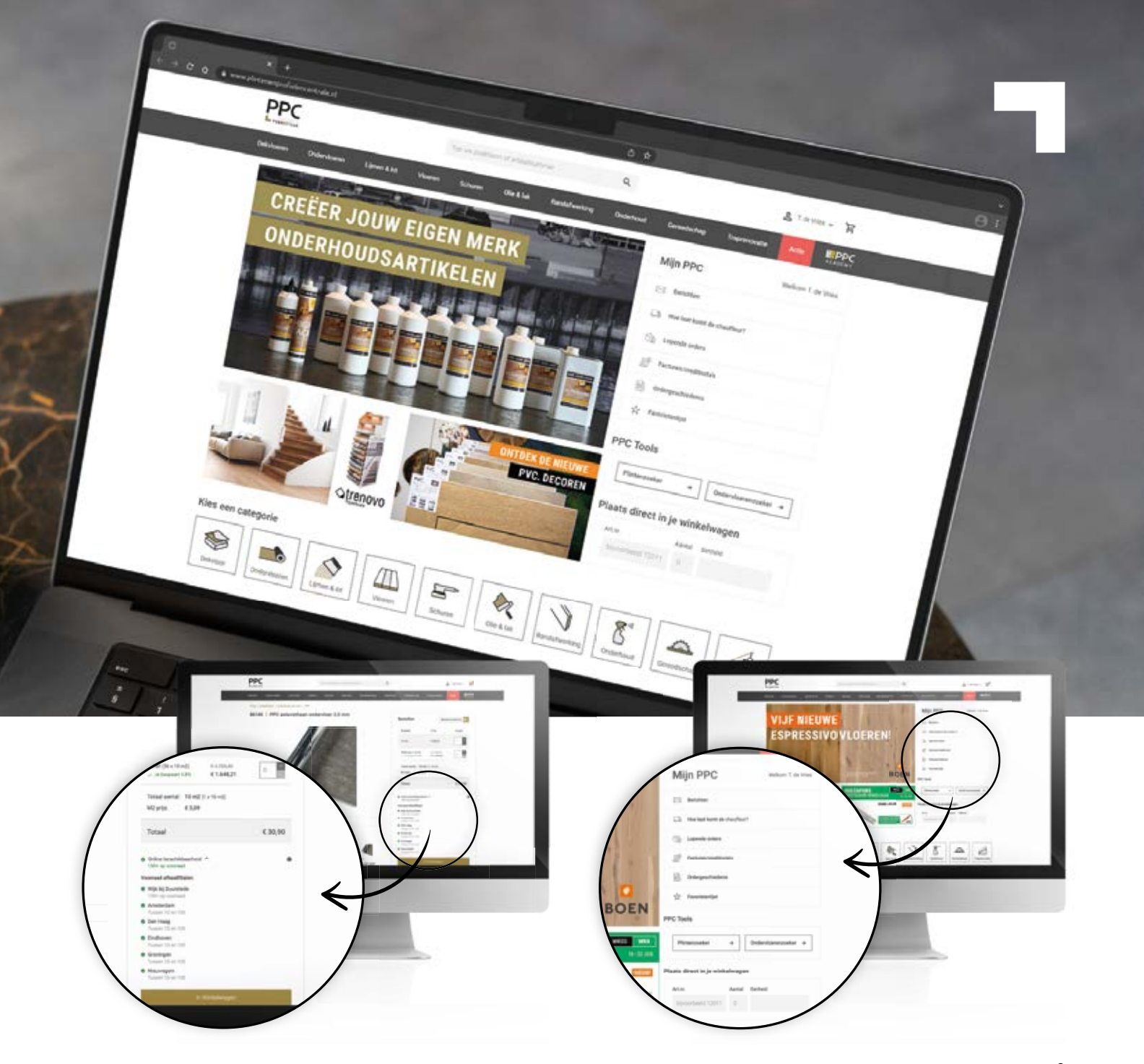

ACTUELE VOORRAADSTATUS PER ARTIKEL

Van al onze producten tonen wij de actuele beschikbaarheid. Per product wordt de voorraad continue bijgewerkt, van zowel de webshop als van onze filialen. Wanneer blijkt dat een bepaald product op de gewenste locatie niet of onvoldoende beschikbaar is, wordt de verwachte levertijd getoond. Het plannen en bestellen is hierdoor nog gemakkelijker en zo kom je niet voor onverwachte verrassingen te staan.

ACTIEPAGINA

OP=OP of artikelen met overvoorraad worden tegen zeer scherpe tarieven aangeboden. Scroll er doorheen, filter op type producten die voor jou interessant zijn en sla je slag!

DE BERICHTENBOX IN MIJN PPC!

Een van de middelen om jou als klant van PPC nog beter van dienst te zijn is de berichtenservice in 'Mijn PPC'. In de berichtenbox ontvang je van ons berichten specifiek voor jou als klant van PPC.

DENK HIERBIJ AAN BERICHTEN ZOALS:

- Wijzigingen in assortimenten/producten die jij regelmatig bestelt
- Wijzigingen in prijzen van producten die jij bij ons bestelt
- Frequente updates van het PPC Academy trainingsaanbod
- Belangrijke webshop updates die jouw gemak vergroten
- Nieuws over PPC ontwikkelingen waarmee wij jou nog beter kunnen bedienen

NR.1 GROOTHANDEL IN PLINTEN

PLINTENENPROFIELENCENTRALE.NL

EN NOG

15.999

ANDERE PRODUCTEN



INSPIRATIE NODIG VOOR HET (HER-)INRICHTEN VAN JE SHOWROOM?

Je bent van harte welkom in de **PPC Experience Centers in onze vestigingen!** Hier laten we de nieuwste trends en inspiratie zien voor jouw showroom. Van brainstormen over hoe we jouw showroom een mooiere uitstraling kunnen geven tot een volledige shop-in-shop presentatie, we denken graag mee!

Maak een afspraak met jouw vertegenwoordiger.



MAKKELIJK AFGEHAALD

Ons motto is "Graag gebracht!" maar soms is afhalen net zo gemakkelijk en past het beter in de planning. Dan is het fijn om in onze filialen even snel de benodigde producten te kunnen afhalen. Dit gemak voor de vloerspecialist, dát is waar wij altijd voor gaan! Voor, tijdens of na het werk snel even iets afhalen kan het hele jaar door! In al onze vestigingen; **Wijk bij Duurstede, Amsterdam, Den Haag, Eindhoven, Groningen en Nieuwegein** ben je zes dagen is de week welkom voor afhalen. De koffie staat klaar!

OPENINGSTIJDEN:

Maandag t/m vrijdag

6:30 – 17:30 uur

Zaterdag

7:30 – 16.00 uur

WIJK BIJ DUURSTED E



Weegmaat 3
3961 NN **Wijk bij Duurstede**

✉ info@plintenenprofielcentrale.nl

☎ 0343 - 432 321

AMSTERDAM



H.J.E. Wenckebachweg 131
1096 AM **Amsterdam**

✉ info@parketgoothandelamsterdam.nl

☎ 020 - 226 10 99

DEN HAAG



Singel 77 (navigatie Poortweg/Bouwplaza)
2497 GS **Den Haag**

✉ info@ppcdenhaag.nl

☎ 070 - 200 20 50

EINDHOVEN



Lodewijkstraat 50 (bedrijventerrein De Hurk)
5652 AC **Eindhoven**

✉ info@ppceindhoven.nl

☎ 040 - 209 20 49

GRONINGEN



Hooghoudtstraat 4
9723 TG **Groningen**

✉ info@ppcgroningen.nl

☎ 050 - 200 30 71

NIEUWEGEIN



Veldwade 8
3439 LE **Nieuwegein**

✉ info@ppcnieuwegein.nl

☎ 030 - 200 68 54



NU OOK IN BELGIË

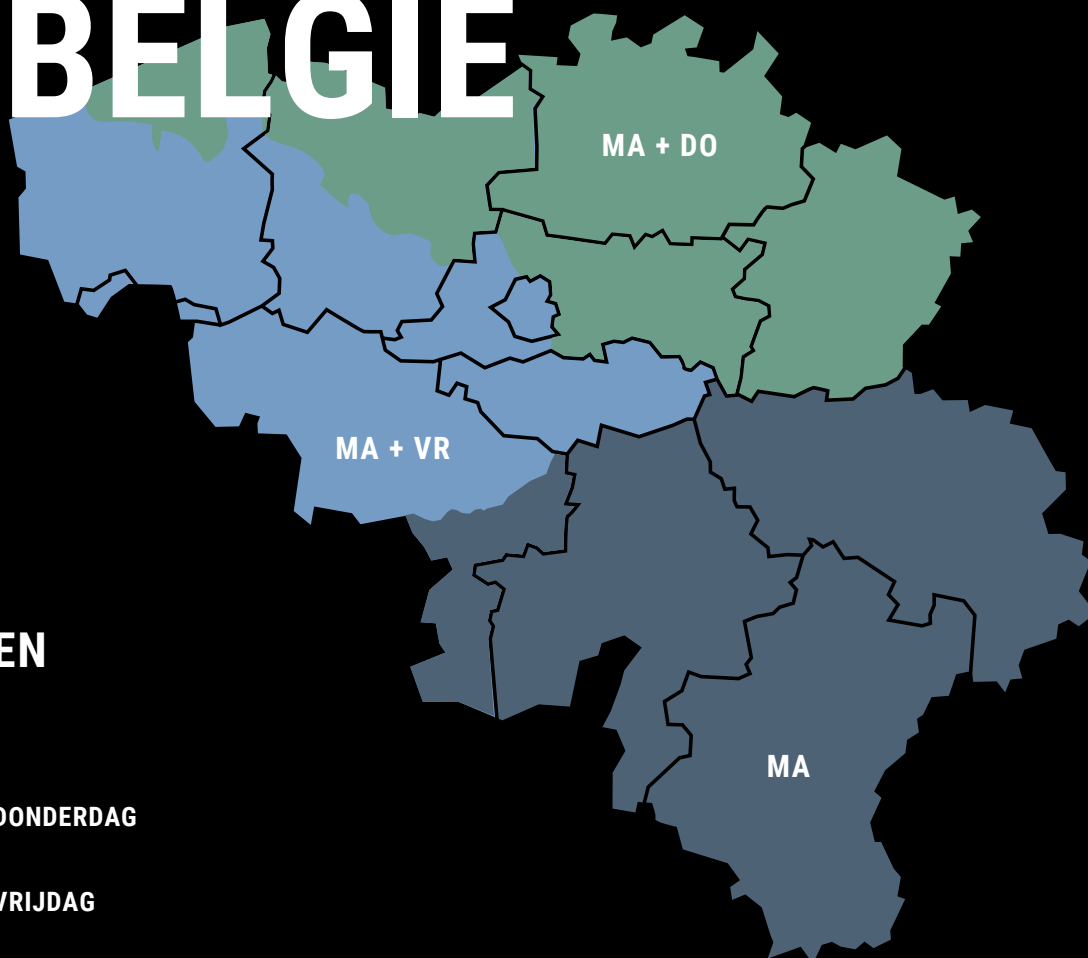

LEVERDAGEN

-  MAANDAG
-  MAANDAG + DONDERDAG
-  MAANDAG + VRIJDAG



PPC bezorgt ook door heel België. Onze standaard leveringen in België zijn net als in Nederland gratis op vaste leverdagen per week, op het vaste afleveradres. De leverdag is afhankelijk van de regionale route.

Bestellingen, op werkdagen geplaatst voor 21.30 uur en op zondag voor 21.30 uur, leveren we de eerstvolgende vaste leverdag. Het maakt niet uit hoe groot de bestelling is, ook één plint leveren we gratis af!



GUNSTIGE RETOUR- REGELING



Wat als je iets bestelt maar de klant dit niet afneemt? In de meeste gevallen kun je dan de bestelde producten gewoon retour melden. Een **gratis service ván ons vóór jou**. Ook het retourneren hebben we gemakkelijk gemaakt. In slechts een paar stappen, via het eigen PPC-account, is de retouraanvraag ingediend.

Onze afdeling Verkoop Binnendienst draagt zorg voor een soepele afhandeling van retouren. Zij zorgen ervoor dat de producten bij de eerstvolgende levering door onze chauffeur gratis retour genomen worden en, dat na controle, de verrekening in orde wordt gemaakt. Als alles in orde is, wordt voor retouren doorgaans het volledige aankoopbedrag teruggegeven. Dit gebeurt middels een creditnota die met nieuwe bestellingen wordt verrekend. Zo voorkom je dat je onverhoopt met producten blijft zitten en houd je de showroom en het magazijn altijd opgeruimd!





ALLES VOOR DE PARKETTEUR!

Alles voor de parketteur, dat is niet voor niets ons motto: met meer dan 16.000 artikelen uit voorraad leverbaar hebben we alles onder een dak.

Als toonaangevende partner voor de vloerspecialist zijn we voortdurend bezig met het doorontwikkelen van ons assortiment. Wij blijven op zoek naar kansen en functionele innovaties om jou te kunnen blijven voorzien van kwaliteitsproducten. We inventariseren continu de behoeftes van de markt en vertalen dat naar unieke concepten en producten. Hierbij verliezen we duurzaamheid en een eerlijke prijs nooit uit het oog. dat naar unieke concepten en producten.

4-UURS GARANTIE

PPC biedt een unieke 4-uurs garantie op vloeren. Doet zich een probleem voor? Dan leveren wij binnen 4 uur vervangend materiaal op de werkvloer! Zo kan je snel weer door.



PPC EN DUURZAAMHEID

Bij PPC vinden we het belangrijk om zo duurzaam mogelijk te ondernemen. We nemen onze verantwoordelijkheid en proberen onze ecologische voetafdruk te minimaliseren.

GECERTIFICEERD HOUT

Om onze mooie natuurproducten te kunnen leveren en tegelijkertijd duurzaamheid te garanderen, zijn wij als bedrijf in het bezit van FSC® en PEFC™ milieucertificaten. Iedere keer dat je producten met het FSC®/PEFC™ keurmerk koopt, kies je voor bescherming van bossen wereldwijd.



DUURZAME BEDRIJFSPANDEN

Op ons dak liggen 662 zonnepanelen, goed voor 166.000 kilowattuur stroom per jaar. Ter vergelijking: dat is genoeg elektriciteit voor 50 huishoudens. De zonnepanelen voorzien het pand van alle benodigde energie en leveren tevens stroom voor onze autolaadpalen, elektrische heftrucks en elektrische pompwagens. Ons filiaal in Groningen is voorzien van een warmtepomp, waardoor er een grote hoeveelheid aan gas wordt bespaard. Verder zijn al onze filialen voorzien van duurzame ledverlichting.

MAGAZIJNBELEID

In ons magazijn doen wij verschillende dingen om het milieu zo min mogelijk te belasten. Zo zijn onze heftrucks, pompwagens en de wasstraat allemaal volledig elektrisch. Uiteraard scheiden wij ons afval en laten we ons papier en karton recyclen. Onze kartonnen dozen zijn 100% FSC gecertificeerd. Zo gaat er geen bos blijvend verloren en dragen we bij aan het verminderen van de CO₂-uitstoot.

RETOUREN HERGEBRUIKEN

We krijgen ook (beschadigde) producten retour van onze klanten. In plaats van deze weg te gooien, proberen we deze producten te hergebruiken. Er worden stalen en POS-materiaal zoals displays voor in showrooms van gemaakt. Zo gooien we zo min mogelijk weg.



INKOOP

PPC koopt maatschappelijk verantwoord in. Dit betekent dat we niet alleen letten op de prijs van producten, maar ook de effecten van de productie op milieu en sociale aspecten in acht nemen. Zo moeten facilitaire zaken zoals papier duurzaam zijn, maar ook bij handelsgoederen wordt erop toegezien dat er in de keten geen sprake is van dwangarbeid, kinderarbeid, hongerlonen en/of discriminatie.

MAATSCHAPPELIJK BETROKKEN

PPC draagt lokale sportclubs en sportieve evenementen een warm hart toe door ze te sponsoren. Ook de medewerkers van PPC wordt gestimuleerd om te bewegen. Zo hebben zij de mogelijkheid om een sportabonnement af te sluiten tegen een gereduceerd tarief. Gezond leven, bewegen en betrokken zijn bij de gemeenschap zijn zaken die hoog in het vaandel staan bij ons bedrijf.



ZOEK, VIND EN BESTEL!

Scan, vind en bestel!

VIND IN 5 STAPPEN DE JUISTE ONDERVLOER

Het kiezen van een geschikte ondervloer is niet altijd eenvoudig. Twijfel je over de juiste ondervloer? Maak dan gebruik van onze ondervloerenzoeker. In slechts vijf stappen worden de ondervloeren gefilterd die passen bij de vloer.

Hoe werkt de ondervloerenzoeker?

Scan de QR-code hiernaast en doorloop de 5 stappen

- 1 **Ondergrond**
Om welke ondergrond gaat het?
- 2 **Vloerverwarming/koeling**
Ga je vloerverwarming/koeling installeren?
- 3 **Type vloer**
Selecteer het type vloer dat je gaat leggen.
- 4 **Soort vloer**
Selecteer de specifieke soort vloer.
- 5 **Gebruikstoepassing**
Selecteer de specifieke toepassing waarin je de vloer en ondervloer gaat gebruiken.

24/7 bereikbaar en altijd up to date!



PLINTEN-ZOEKER

Zoek je de juiste randafwerking bij een bepaalde vloer? Gebruik de plintenzoeker op onze webshop. In vier stappen vind je snel en makkelijk de juiste plint. Voor bijna alle merken vind je de juiste randafwerking in het uitzonderlijk brede assortiment voor laminaat, PVC en parket. Alles voor het gemak!



TRAPRENOVATIE BESTELTOOL

BESTEL IN EEN HANDOMDRAAI EEN COMPLETE TRAP!

Met de traprenovatie besteltool bestel je in een handomdraai een complete trap. In deze tool kan je **kiezen uit onze drie traprenovatie merken: Trenovo, MexForm en Natural Wood**. Van elk merk staan alle producten bij elkaar in deze overzichtelijke tool. In drie makkelijke stappen maak je eenvoudig een bestellijst met de producten die je nodig hebt voor je klus.

Met de traprenovatie besteltool van PPC bespaar je veel tijd! Alles voor het gemak van de parketteur en vloerenspecialist.

Maak kennis met de traprenovatie besteltool en ervaar het gemak. Scan de QR-code en begin meteen.

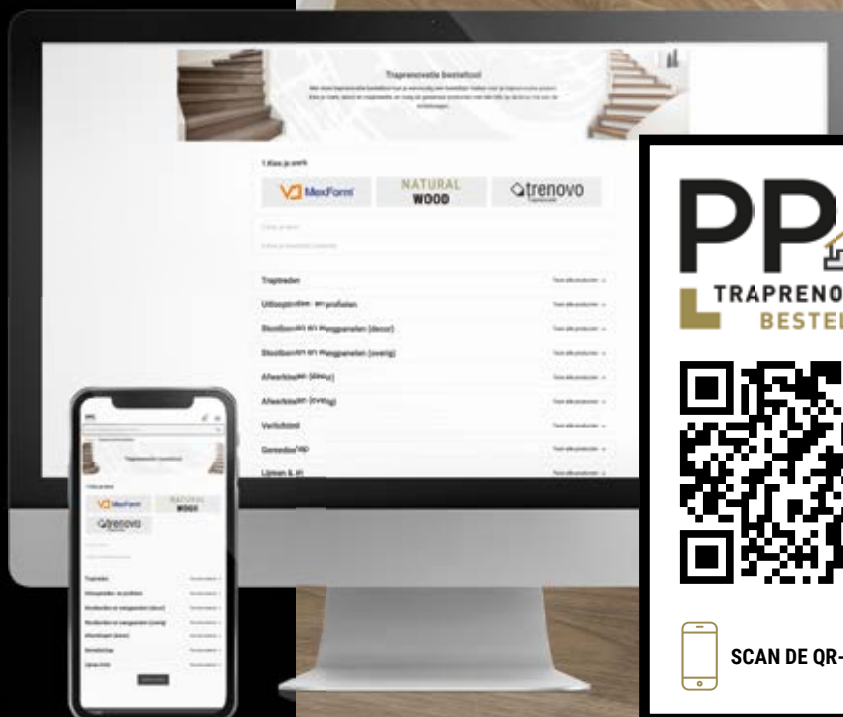



PROBEER DE
ROOMDESIGNER
SCAN DE QR-CODE

ROOMDESIGNER

Soms is het lastig om vanaf een sample te bepalen of de vloer, die je klant heeft uitgekozen in huis past. Past de vloer bij de bank? Welke legwijze kies ik om de ruimte het best tot zijn recht te laten komen? Deze en meer vragen over de juiste vloer zijn gemakkelijk te beantwoorden met de Roomdesigner. Maar hoe bepaal je welke vloer hiervoor de juiste is? Naast een aantal standaard ruimtes kan de klant zelf gemakkelijk een foto uploaden van de ruimte waar de vloer moet komen te liggen.

Benieuwd? Probeer de Roomdesigner zelf uit en check welke merken er allemaal beschikbaar zijn.

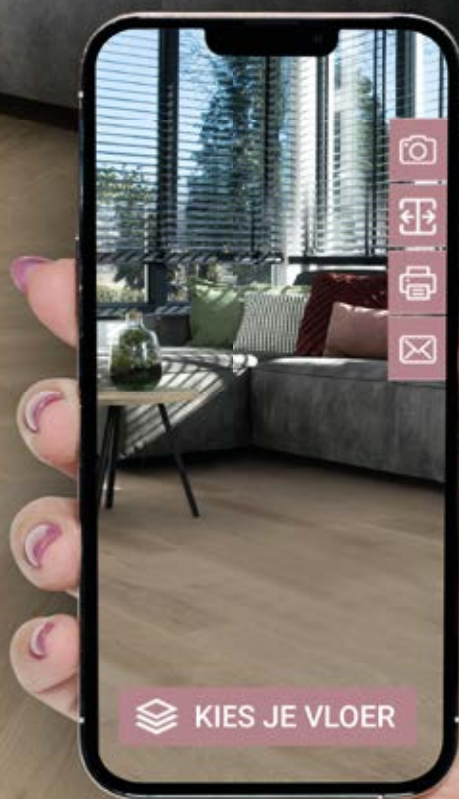

PPC ACADEMY ALLE KENNIS IN HUIS

PPC is veel meer dan alleen een groothandel. We vinden het belangrijk dat onze klanten de kennis in huis hebben om de beste kwaliteit te leveren én om het maximale uit onze producten te halen. Daarom organiseren wij regelmatig trainingen, zodat we iedereen op de hoogte houden over de nieuwste trends en laatste productontwikkelingen in de markt.

Maak kennis met de PPC Academy, ons speciale kennis- en opleidingscentrum voor de parketteur en de vloerspecialist. Dé plek waar jij jouw vak- en productkennis naar een hoger niveau kan tillen.

In de PPC Academy bieden wij het hele jaar door een gevarieerd programma aan trainingen. Van traprenovatie tot aan kennis van olie en lak, en van patronen leggen tot aan PVC renovatie. Daarnaast hebben we op onze website een handige e-learning module met tips & tricks. Zo ben je altijd op de hoogte van de laatste ontwikkelingen in de markt en kun je jouw werk nog optimaler uitvoeren.



Schrijf je in voor één van de trainingen in de PPC Academy, hét opleidingscentrum voor de parketteur en de vloerspecialist.

Scan de QR-code voor het actuele overzicht van alle geplande trainingen en de beschikbare inschrijfdata.

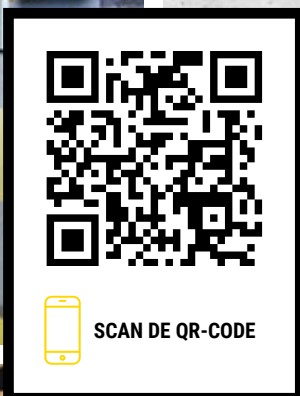

Scan deze QR-code voor meer informatie



[PLINTENENPROFIELENCENTRALE.NL/ACADEMY](https://plintenenprofielcentrale.nl/academy)

PPC
ACADEMY

ALLE KENNIS IN HUIS

ALLES IN EIGEN HUIS MET DE MONSTERMAKERIJ JORIS HOUDT VAN AFWISSELING

Sinds 2009 heeft PPC een eigen monstermakerij. Met een oppervlakte van 1.157 m² is dat een afdeling waar van alles gemaakt én geproduceerd wordt. Denk hierbij aan displays, monsterstalen, het beheren van de sample service, het maken van winkelrichtingen op maat én het bouwen van onze eigen stands. En dit is nog maar een kleine selectie. In de werkplaats van de monstermakerij staat een kantenbandmachine, CNC-freesmachine en een etiketeer machine.

Daarnaast geven de professionals van de monstermakerij ook trainingen in onze eigen PPC Academy. Kortom een afdeling waar geen dag hetzelfde is!





1. DEKVLOEREN

| | | |
|------------|------------------------------------|-----------|
| 1.1 | BEOORDELEN | 20 |
| 1.1.1 | GEREEDSCHAP | 20 |
| 1.1.2 | VOCHTMETERS | 20 |
| 1.2 | SCHUREN EN LIJM VERWIJDEREN | 20 |
| 1.3 | VOORSTRIJKEN PER MERK | 21 |
| 1.3.1 | THOMSIT | 21 |
| 1.3.2 | STAUF | 21 |
| 1.3.3 | BONA | 21 |
| 1.3.4 | KERAKOLL | 22 |
| 1.3.5 | WAKOL | 22 |
| 1.3.6 | VOORSTRIJK GEREEDSCHAP | 22 |
| 1.4 | EGALISEREN | 23 |
| 1.4.1 | THOMSIT | 23 |
| 1.4.2 | STAUF | 23 |
| 1.4.3 | KERAKOLL | 24 |
| 1.4.4 | WAKOL | 24 |
| 1.4.5 | EGALISEER GEREEDSCHAP | 24 |
| 1.5 | DROOGBOUW VLOERSYSTEMEN | 27 |
| 1.5.1 | REDUPANEL | 27 |
| 1.5.2 | JUMPAX | 27 |

1 DEKVLOEREN

1.1 BEOORDELEN

1.1.1 GEREEDSCHAP

| Handgereedschap | Afmeting | Artikelnr. |
|--|----------|------------|
|  | | 85325 |
|  | 60 cm | 85543 |
| | 100 cm | 85541 |
| | 200 cm | 85542 |
|  | | 85584 |

1.1.2 VOCHTMETERS

| Meetapparatuur | Artikelnr. |
|---|------------|
|  | 85278 |
|  | 85280 |
|  | 85279 |
|  | 85285 |
|  | 85291 |
|  | 85287 |

1.2 SCHUREN EN LIJM VERWIJDEREN

| Gereedschap | Korrel | Afmeting | Artikelnr. |
|---|----------|------------|------------|
|  | | | 97900 |
|  | K24 | 16 inch | 95202 |
| | K40 | 16 inch | 95204 |
| | K120 | 16 inch | 95206 |
|  | | 16 inch | 97905 |
|  | | 16 inch | 97906 |
|  | | 16 inch | 97916 |
|  | | 100 mm | 97908 |
| Collomix | Type | Artikelnr. | |
|  | CMG 1700 | 92437 | |
|  | | 92439 | |
|  | | 92440 | |
|  | | 92441 | |
|  | | 92442 | |
|  | CMG 2600 | 92444 | |
|  | | 92446 | |

1.2 SCHUREN EN LIJM VERWIJDEREN (vervolg)

| Collomix | Type | Artikelnr. |
|---|--|----------------------------------|
|  | Lamellenringset | CMG 1700 92443 CMG 2600 92447 |
|  | Koolborstelset | CMG 1700 92438 CMG 2600 92445 |
|  | Meer gereedschappen zijn te vinden in hoofdstuk 9: Gereedschap of kijk in onze webshop. | |

1.3 VOORSTRIJKEN PER MERK





1.3.1 THOMSIT

| Voorstrijk | Inhoud | Artikelnr. |
|---|--|---------------------------|
|  | R777 Dispersievoorstrijk Readymixed Ca. 100-300 gram per m ² | 10 kg 96510 |
|  | BasicPrimer Ca. 50-150 gram per m ² | 10 kg 96541 |
|  | R766 Multi Primer Ca. 150-200 gram per m ² | 10 kg 96517 |
|  | R740 1-K-PU Reno Express voorstrijk Ca. 80-300 gram per m ² per laag | 12 kg 96518 |
|  | R745 Dispersie vochtscherm Ca. 160 gram per m ² | 10 kg 96508 |
|  | R755 2K Epoxy vochtscherm Ca. 300 gram per m ² Aanbrengen in 2 lagen | 7 kg 96520 21 kg 96509 |
|  | Kwartzand QS10 0,3-0,8 mm Ca. 2 kg per m ² | 25 kg 96521 |
|  | R790 Vul- en voorstrijkmiddel Ca. 200-800 gram per m ² | 14 kg 96514 |

1.3.2 STAUF

| Voorstrijk | Inhoud | Artikelnr. |
|--|---|---------------------------|
|  | Dispersie Multi Primer VDP 130 Ca. 125 gram per m ² | 10 kg 96402 |
|  | Dispersie voorstrijk VDP 160 (tegels) Ca. 125 gram per m ² | 10 kg 96414 |
|  | 1K PU Primer VPU 155 S (sneldrogend) Ca. 200 gram per m ² | 5 kg 96405 11 kg 96404 |
|  | 2K Epoxy primer/vochtscherm VEP 195 Ca. 400 gram per m ² | 3 kg 96406 10 kg 96407 |
|  | WEP 180 watergedragen epoxy Ca. 150-200 gram per m ² | 3,5 kg 96433 |
|  | Kwartzand Ca. 2,5-3,0 kg per m ² | 25 kg 96430 |

1.3.3 BONA

| Voorstrijk | Inhoud | Artikelnr. |
|---|---|------------|
|  | D500 Dispersie voorstrijk Verdund 150 milliliter per m ² Geconcentreerd 75 milliliter per m ² | 5 l 96751 |
|  | D501 Primer Ca. 100-150 milliliter per m ² | 5 l 96759 |
|  | R540 1K PU primer/vochtscherm voor R770 Ca. 100-150 gram per m ² (gronden) Ca. 250-350 gram per m ² (vochtscherm) Aanbrengen in 2 lagen | 6 kg 96764 |
|  | R590 Silaan vochtscherm Ca. 500 gram per m ² | 8 kg 96769 |
|  | R410 Epoxy voorstrijk Ca. 150-250 gram per m ² (gronden) Ca. 500 gram per m ² (vochtscherm) | 5 kg 96750 |

1 1.3.4 KERAKOLL

| Voorstrijk | Inhoud | Artikelnr. |
|---|-----------------------|-------------------------|
|  Keragrip PU-L-EP gripbevorderaar Ca. 30 milliliter per m ² | 1 l | 96605 |
|  SLC Active Prime Fix Ca. 100-200 gram per m ² | 1 kg 5 kg 25 kg | 96661 96663 96670 |
|  SLC Eco EP21 2K Ca. 200-300 milliliter per m ² | 3,5 l | 96609 |
|  SLC Eco Rapid EP21 2K Ca. 200-400 milliliter per m ² | 3 l | 96608 |
|  SLC Vochtscherm voor tegels 3CW Ca. 500 gram per m ² | 5 kg | 96607 |

1.3.5 WAKOL

| Voorstrijk | Inhoud | Artikelnr. |
|--|-------------|----------------|
|  D 3004 Voorstrijkconcentraat Ca. 100-150 gram per m ² | 10 kg | 77133 |
|  D 3045 Speciaal voorstrijkmiddel Ca. 100-150 gram per m ² | 12 kg | 77132 |
|  D 3055 Parketvoorstrijkmiddel Ca. 100-150 gram per m ² | 10 kg | 77134 |
|  PU 280 Voorstrijk Ca. 100-150 milliliter per m ² als voorstrijkmiddel 250-350 milliliter per m ² ter voorkoming van vocht. Aanbrengen in 2 lagen | 5 l 11 l | 77030 77083 |
|  MS 330 Silaan voorstrijkmiddel Ca. 80-120 gram per m ² | 10 kg | 77135 |





1.3.6 VOORSTRIJK GEREEDSCHAP

| Gereedschap | Afmeting/inhoud/stuks | Artikelnr. |
|--|-----------------------|----------------|
|  Velours/mohairroller | 25 cm | 92192 |
|  Beugel voor lakroller | 10 cm 25 cm | 92198 92193 |
|  Vorstrijkroller met beugel | 25 cm | 92208 |
|  Grote plastic lakemmer | 12 l | 98977 |
|  Inlay voor grote plastic lakemmer | 12 l 5 stuks | 98976 |
|  Rooster voor lakemmer | 12 l | 98978 |
|  Rigo professionele lakbak | 9 l | 92183 |
|  Inlay voor Rigo lakbak | 9 l 5 stuks | 92184 |

1.4 EGALISEREN

1.4.1 THOMSIT

| Egaline | Inhoud | Artikelnr. |
|--|--------|------------|
|  R 729 Giethars dekvloerreparatie 2 componenten | 600 ml | 96596 |
|  OS PVC projectegaline Ca. 1,5 kg per m ² per 1 mm laagdikte | 25 kg | 96532 |
|  DX Egalisatie PVC/parket Ca. 1,5 kg per m ² per 1 mm laagdikte | 25 kg | 96522 |
|  RS 88 Renovatie egaliseermiddel Ca. 1,5 kg per m ² per 1 mm laagdikte | 25 kg | 96529 |
|  RS 100 renovatie egaliseermiddel Ca. 1,5 kg per m ² per 1 mm laagdikte | 25 kg | 96538 |
|  RS Fix fijn reparatiemiddel Ca. 1,2 kg per m ² per 1 mm laagdikte | 5 kg | 96528 |
|  BasicCem cement-egaliseermiddel Ca. 1,5 kg per m ² per 1 mm laagdikte | 25 kg | 96539 |
|  BasicGyp gips-egaliseermiddel Ca. 1,6 kg per m ² per 1 mm laagdikte | 25 kg | 96540 |
|  DS 40 Egaline voor dikke lagen Ca. 1,7 kg per m ² per 1 mm laagdikte | 25 kg | 96536 |
|  XXL Power stofarme egalisatie Ca. 1,5 kg per m ² per 1 mm laagdikte | 25 kg | 96524 |
|  XXL Express stofarme egalisatie Ca. 1,5 kg per m ² per 1 mm laagdikte | 25 kg | 96525 |
|  AS 1 Rapid anhydrietegalisatie Ca. 1,5 kg per m ² per 1 mm laagdikte | 25 kg | 96523 |
|  AS 2 Vezelversterkt anhydrietegalisatie Ca. 1,5 kg per m ² per 1 mm laagdikte | 25 kg | 96526 |
|  SL 85 Systeemegalisatie Ca. 1,5 kg per m ² per 1 mm laagdikte | 25 kg | 96531 |

| Egaline | Inhoud | Artikelnr. |
|---|---------------------|------------|
|  FA 97 Vezelversterkt egaliseermiddel Ca. 1,5 kg per m ² per 1 mm laagdikte | 25 kg | 96534 |
|  TF 300 Wapeningsnet 50 m x 1 m | 50 m ² | 96599 |
|  TF 303 Project Floor 12 m x 1,25 m | 15 m ² | 96527 |
|  TF 501 Isolerende onderlaag 1 mm 12,5 m x 1 m | 12,5 m ² | 96537 |

1.4.2 STAUF

| Egaline | Inhoud | Artikelnr. |
|--|--------|------------|
|  SGH 50 2K Silikat giethars | 0,8 kg | 96429 |
|  XP 10 PVC/parket egaline Ca. 1,5 kg per m ² per 1 mm laagdikte | 25 kg | 96420 |
|  XP 20 Cementgebonden egaline Ca. 1,5 kg per m ² per 1 mm laagdikte | 25 kg | 96419 |
|  FZ Cementgebonden egaline (dikke lagen) Ca. 1,8 kg per m ² per 1 mm laagdikte | 25 kg | 96415 |
|  SSP Rapid snelle egaline op cementbasis Ca. 1,5 kg per m ² per 1 mm laagdikte | 25 kg | 96403 |
|  Krimpvrije mortel RM Ca. 1,5 kg per m ² per 1 mm laagdikte | 25 kg | 96411 |
|  Anhydriet egaline GS Ca. 1,5 kg per m ² per 1 mm laagdikte | 25 kg | 96409 |
|  PU oplosmiddelvrije 2K PU egaline Ca. 1,5 kg per m ² per 1 mm laagdikte | 14 kg | 96426 |

1 1.4.2 STAUF (vervolg)

| Egaline en toebehoren | Inhoud/stuks | Artikelnr. |
|--|--------------------------|----------------|
|  Turbo-Fix 2K herstelplamuur Ca. 1,1 kg per m ² per 1 mm laagdikte | 2 x 4,5 kg | 96428 |
|  Gipsgebonden reparatiemassa Ca. 1,3 kg per m ² per 1 mm laagdikte | 25 kg | 96422 |
|  Glasvezels voor egaline | 250 gr | 96470 |
|  Polyestervlies | 25 m ² | 96434 |
|  Dekvloerkrammen | 1.000 stuks 100 stuks | 96431 96432 |
|  Isolerende onderlaag | | |
| 2 mm | 30 m ² | 96435 |
| 3 mm | 20 m ² | 96436 |
| 5 mm | 12,5 m ² | 96440 |
|  Ongelamineerde ontkoppelingsplaat | | |
| 4 mm | 0,6 m ² | 96441 |
| 9 mm | 0,6 m ² | 96443 |
| 15 mm | 0,6 m ² | 96447 |

1.4.3 KERAKOLL

| Egaline | Inhoud | Artikelnr. |
|---|--------|------------|
|  Planogel Rheo egaline Ca. 1,6 kg per m ² per 1 mm laagdikte Dikte van 1 tot 30 mm | 25 kg | 96658 |
|  Flowtech Easy egaline Ca. 1,6 kg per m ² per 1 mm laagdikte Dikte van 3 tot 15 mm | 25 kg | 96659 |
|  Keralevel Eco LR Ca. 1,3 kg per m ² per 1 mm laagdikte Dikte van 1 tot 25 mm | 25 kg | 96667 |

1.4.4 WAKOL

| Egaline | Inhoud | Artikelnr. |
|---|--------|------------|
|  Z610 Egaliseermiddel Ca. 1,5 kg per m ² per 1 mm laagdikte | 20 kg | 77141 |
|  Z675 Egaliseermiddel Ca. 1,5 kg per m ² per 1 mm laagdikte | 25 kg | 77128 |
|  Z680 Project egaliseermiddel Ca. 1,5 kg per m ² per 1 mm laagdikte | 25 kg | 77075 |
|  A830 Egaliseermiddel Ca. 1,5 kg per m ² per 1 mm laagdikte | 25 kg | 77138 |
|  AR114 Wapeningsvezels Mengverhouding per 25 kg egaliseermiddel 1 zak Wakol AR114 | 250 gr | 77136 |

1.4.5 EGALISEER GEREEDSCHAP

| Festool | Artikelnr. |
|---|------------|
|  Mengmachine MX 1000 RE EF HS3R | 88257 |
|  Mengmachine MX 1600/2 RE EF HS3R | 88258 |
|  Mengmachine MX 1000 RE EF HS2 | 88293 |
|  Mengmachine MX 1200 RE EF HS3R | 88294 |

MENGMACHINE TOEPASSINGS-OVERZICHT

Hier vind je voor elk mengsel de juiste oplossing.











Scan de QR-code en download de PDF



1.4.5 EGALISEER GEREEDSCHAP (vervolg)

| Festool | | Artikelnr. |
|---|----------------------------------|------------|
|  | Mengmachine MX 1200 RE EF HS2 | 88295 |
|  | Mengmachine MX 1200/2 RE EF HS3R | 88296 |
|  | Roergarde CS 120x600 M14 | 88028 |

| Pajarito | Afmeting | Artikelnr. |
|---|-------------------------|-------------------------|
|  | | 92261 |
|  | 56 cm | 92265 |
|  | 56 cm | 92269 |
|  | 1 mm 2 mm 3 mm | 92266 92267 92268 |
|  | 25 cm 50 cm 75 cm | 92271 92274 92272 |
|  | | 92275 |

| Collomix | Aansluiting | Artikelnr. |
|---|-------------|----------------|
|  | HF | 92380 |
|  | | 92381 |
|  | HF | 92382 |
|  | | 92383 |
|  | HF M14 | 92406 92408 |
|  | HF M14 | 92407 92409 |
|  | HF M14 | 92400 92402 |
|  | HF M14 | 92401 92403 |
|  | HF M14 | 92396 92398 |
|  | HF M14 | 92397 92399 |













MIXWIJZER

Niet helemaal zeker welke mixer en mengstaaf je nodig hebt voor jouw project? Dankzij de MIX Atlas / Mix wijzer van Collomix vind je eenvoudig de juiste mixoplossing voor jouw klus. Filter op materiaal, producent of bouwsector en zie direct welke mixers Collomix adviseert.

Scan de QR-code of ga naar:
Mixingatlas.com



1 1.4.5 EGALISEER GEREEDSCHAP (vervolg)

| Collomix | Inhoud | Artikelnr. |
|---|---|------------|
|  | Mengstaaf LX 70 S | 92404 |
|  | Mengstaaf LX 90 S | 92405 |
|  | Mengstaaf FM 80 S | 92410 |
|  | Mengstaaf WK 90/500 S | 92395 |
|  | Mobiël mengapparaat LevMix | 92424 |
|  | Mengemmer voor LevMix | 75 l 92428 |
|  | Uitgiet snavel voor LevMix | 92425 |
|  | Mengstaaf VLX 160 HF voor LevMix | 92426 |
|  | Mengstaaf VLX 163 HF voor LevMix | 92427 |
|  | Mobiële stofafzuiging Dust.Ex | 92420 |
|  | Mix.GRIP fixeerpedaal | 92421 |
|  | Sharky zakkenscheurder klein | 92422 |
|  | HEXAFIX snelkoppeling met M14 aansluiting | 92384 |
|  | M14 adapter voor HEXAFIX machine | 92385 |

| | Inhoud | Artikelnr. |
|---|---|------------|
|  | Verlengstuk 100 mm voor HEXAFIX-koppeling | 92386 |
|  | Mixer Clean | 30 l 92419 |
|  | Mengemmer | 30 l 92423 |

| Overig | Afmeting/inhoud | Artikelnr. |
|---|--------------------------------------|----------------------|
|  | Thomsit aanmaakemmer voor egalisatie | 30 l 92263 |
|  | Thomsit maatbeker/emmer | 10 l 92264 |
|  | Stauf maatemmer | 10 l 96487 |
|  | Stauf mengemmer voor egaline | 30 l 96486 |
|  | Teleskoopsteel | 200 cm x 25 mm 92195 |
|  | Vloertrekker | 92273 |

TIP!



Meer gereedschappen zijn te vinden in hoofdstuk 9: Gereedschap of kijk in onze webshop.

1.5 DROOGBOUW VLOERSYSTEMEN

1.5.1 REDUPANEL

| | Afmeting | Inhoud | Artikelnr. |
|---|--|--|----------------|
|  | Redu-panel 25 mm 600 mm x 2.400 mm | 1,44 m ² | 86584 |
|  | Cocofloor voor Redupanel/Jumpax Prefab 10 dB 4 mm 8 mm | 15 m ² 15 m ² | 86590 86537 |
|  | Unifloor kantband | 10 m | 86586 |
|  | Ecopearls egalisatie | 18,5 kg | 86566 |
|  | EcoFleece dampdoorlatende onderlaag | 60 m ² | 86588 |

Unifloor productbox

| | Artikelnr. |
|---|-----------------------|
|  | Unifloor Box 86539 |
|  | Jumpax Box 86538 |

TIP!

Meer inzicht in de mogelijkheden van Jumpax? Vraag de vertegenwoordiger naar de Unifloor en/of Jumpax Box of bestel ze in onze webshop.

1.5.2 JUMPAX

| Unifloor ondervloerplaten | Afmeting | Inhoud | Artikelnr. |
|---|---|---------------------|------------|
|  | Jumpax Acoustic 10 dB 600 mm x 1.200 mm 18 mm | 0,72 m ² | 86536 |
|  | Jumpax Basic voor PVC/linoleum/kurk 600 mm x 1.200 mm 7 mm | 2,88 m ² | 86568 |
|  | Jumpax Classic (original/dual) 600 mm x 1.200 mm 10 mm | 2,88 m ² | 86564 |
|  | Jumpax HD 600 mm x 1.200 mm 10 mm | 2,88 m ² | 86576 |
|  | Jumpax Nature 600 mm x 1.200 mm 14 mm | 2,88 m ² | 86578 |
|  | Heatpak Plus 600 mm x 1.200 mm 7 mm | 1,44 m ² | 86149 |
|  | Jumpax Prefab 10 dB contactgeluidreducerend ondervloersysteem voor 11 mm prefab tapis | 86578 & 86590 | |
| Dikte 18,5 mm Let op! Bestaat uit twee gecombineerde producten. | | | |



VAKKUNDIGE EN VRIENDELIJKE MEDEWERKERS



FLORIS HELPT JE GRAAG VERDER!

Klantvriendelijkheid staat bij PPC hoog in het vaandel, vraag dat maar aan Floris van Dijk, teamleider verkoop binnendienst. 'Wij hebben een gedreven team van vakkundige medewerkers in huis die elke dag paraat staan om onze klant te voorzien van het juiste advies op maat. Maandelijks wordt het team bijgepraat over alle nieuwe producten van PPC en updates in de markt. Op deze manier wordt onze vakkennis vergroot en kunnen we ons werk optimaal uitvoeren. Ons team zit dagelijks voor je klaar om je te adviseren en te helpen!'

Heb je advies nodig? Of hulp bij een bestelling?

Neem dan contact op met onze binnendienst:

0343 - 432 321 en wellicht krijg je Floris dan aan de lijn.

2. ONDERVLOEREN

2

| | | |
|-----|---------------------------|----|
| 2.1 | TE VERLIJMEN ONDERVLOEREN | 30 |
| 2.2 | ZWEVENDE ONDERVLOEREN | 30 |
| 2.3 | LEGMATERIALEN | 34 |



2.1 TE VERLIJMEN ONDERVLOEREN

2.2 ZWEVENDE ONDERVLOEREN

Mozaïek *Artikelnr.*



Eiken mozaïek ondervloer 86652
mooie kwaliteit
 Afmeting 16x16 cm
 Dikte 8 mm
 Inhoud 4,92 m²

Spaanplaat broodjes *Artikelnr.*



Broodjes
 650 kg/m³ geschuurd P2 kwaliteit
 Afmeting 20x15 cm, *30x15 cm

| Dikte | Inhoud | |
|--------|---------------------|-------|
| 8 mm | 2,95 m ² | 86601 |
| 10 mm | 2,40 m ² | 86605 |
| 12 mm | 2,03 m ² | 86611 |
| 12 mm* | 2,16 m ² | 86612 |
| 15 mm | 1,66 m ² | 86618 |
| 18 mm | 1,29 m ² | 86625 |
| 22 mm | 1,10 m ² | 86631 |

Spaanplaat platen *Artikelnr.*



Platen
 650 kg/m³ geschuurd P2 kwaliteit

| Dikte | Afmeting | |
|-------|-----------|-------|
| 8 mm | 83x125 cm | 86603 |
| 10 mm | 83x125 cm | 86607 |
| 12 mm | 83x125 cm | 86613 |
| 15 mm | 83x125 cm | 86619 |
| 18 mm | 83x125 cm | 86627 |
| 22 mm | 83x125 cm | 86633 |

Rubber/kurk *Artikelnr.*



Thomsit ondervloer 96527
TF 303 Project Floor
 Dikte 3 mm
 Inhoud 15 m²



Stauf isolerende onderlaag

| Dikte | Inhoud | |
|-------|---------------------|-------|
| 2 mm | 30 m ² | 96435 |
| 3 mm | 20 m ² | 96436 |
| 5 mm | 12,5 m ² | 96440 |

PPC ondervloeren op rol *Artikelnr.*



Polyurethaan ondervloer 2,0 mm 86145
 laminaat, parket
 Dikte 2 mm
 Inhoud 10 m²



Premium polyurethaan ondervloer 3,2 mm 86144
 laminaat, parket
 Dikte 3,2 mm
 Inhoud 7 m²



Alufoam 2 mm + 20 cm overlap met plakstrip 86100
 laminaat, parket
 Dikte 2 mm
 Inhoud 15 m²



Spemi HDR combi-ondervloer 86109
 +10 dB laminaat
 Dikte 1,7 mm
 Inhoud 15 m²



Zelfklevende ondervloer 86107
 voor (verlijmd) PVC
 Dikte 1,8 mm
 Inhoud 6,5 m²



LVT click PU ondervloer - 440 kPa 86147
 laminaat, PVC
 Dikte 1,5 mm
 Inhoud 10 m²

Unifloor ondervloeren op rol *Artikelnr.*



Heat-Foil 200 mu 86141
 +10 dB laminaat, lamelparket
 Dikte 1,2 mm
 Inhoud 15 m²



Blue Floor 10 dB ondervloer 86136
 laminaat
 Dikte 2 mm
 Inhoud 15 m²



Heatblok ondervloer
 kurk, PVC stroken, linoleum

| Dikte | Inhoud | |
|-------|-------------------|-------|
| 6 mm | 25 m ² | 86811 |
| 8 mm | 25 m ² | 86812 |



RedFloor 1.0 400 kPa + 10 dB PVC klik 86148
 laminaat, PVC
 Dikte 1 mm
 Inhoud 15 m²



Green Floor ondervloer 86587
 Dikte 3 mm
 Inhoud 25 m²



Cocofloor
 voor Redupanel/Jumpax Prefab 10 dB

| Dikte | Inhoud | |
|-------|-------------------|-------|
| 4 mm | 15 m ² | 86590 |
| 8 mm | 15 m ² | 86537 |

PROMOTIE-MATERIAAL

Ondervloerenmap

Een stevige map, met daarin alle informatie van de ondervloer op een losse kaart. Met een echt stukje ondervloer.

Artikelnr. 99985



SAMPLES SERVICE

Van al onze ondervloeren zijn samples te bestellen via de webshop. Scan de QR-code!

Of ga naar: Ondervloeren > Promotiemateriaal > Samples

BESTEL JE SAMPLES







SCAN DE QR-CODE

2.2 ZWEVENDE ONDERVLOEREN (vervolg)

| Estillon ondervloeren op rol | Artikelnr. |
|---|------------|
|  Whisper Black + 10 dB PVC klik PVC stroken (klik) Dikte 1 mm Inhoud 10 m ² | 86645 |
|  Woodstep laminaat, lamelparket, duoplank, massieve plank 20 mm Dikte 3 mm Inhoud 11 m ² | 86644 |
|  Timbermate Excel laminaat, lamelparket, duoplank, massieve plank 20 mm Dikte 3,6 mm Inhoud 15,07 m ² | 86643 |
|  Black Pearl tapijt (verlijmd) Dikte 5 mm Inhoud 10 m ² | 86641 |
|  Egalsoft tapijt (verlijmd) Dikte 6,5 mm Inhoud 30,14 m ² | 86642 |
|  Duralay LVT Multi-Fit laminaat, lamelparket, PVC stroken Dikte 1,5 mm Inhoud 10 m ² | 86634 |

| Quick-Step ondervloeren op rol | Artikelnr. |
|---|------------|
|  Basis ondervloer laminaat, lamelparket Dikte 2 mm Inhoud 15 m ² | 09209 |
|  Basis plus 2 in 1 ondervloer laminaat, lamelparket Dikte 2 mm Inhoud 15 m ² | 09208 |
|  Silent walk 2 in 1 looppeluid reducerend laminaat, lamelparket Dikte 2 mm Inhoud 7 m ² | 09206 |
|  Unisound Combi laminaat, lamelparket, PVC op HDF drager Dikte 2 mm Inhoud 15 m ² | 07528 |

| Quick-Step ondervloeren op rol | Artikelnr. |
|--|------------|
|  Transitsound contactgeluid reducerend laminaat, lamelparket, PVC op HDF drager Dikte 3 mm Inhoud 15 m ² | 09215 |
|  Comfort PVC ondervloer PVC stroken (klik) Dikte 1,15 mm Inhoud 15 m ² | 09448 |
|  Heat PVC ondervloer PVC stroken (klik) Dikte 1,55 mm Inhoud 10 m ² | 09449 |
|  Transit PVC ondervloer 10 dB PVC stroken (klik) Dikte 1,2 mm Inhoud 15 m ² | 09450 |

| PPC ondervloerplaten | Artikelnr. |
|---|-----------------------------------|
| PPC groene ondervloerplaat | |
| Dikte 4 mm | Inhoud 12,04 m ² 86551 |
| Dikte 7 mm | Inhoud 10,03 m ² 86555 |
| PPC 10 dB ondervloerplaat laminaat | 86557 |
| Dikte 10 mm | Inhoud 4,66 m ² |
| PPC XPS-plaat | 86544 |
| Dikte 5 mm | Inhoud 9,6 m ² |

| Unifloor ondervloerplaten | Artikelnr. |
|---|------------|
|  Redupax +10 dB laminaat, lamelparket, PVC Dikte 9 mm Inhoud 8,12 m ² | 86561 |
|  Soundkiller +10 dB lamelparket Dikte 15 mm Inhoud 4,06 m ² | 86571 |
|  Redupanel 240x60 cm Dikte 25 mm Inhoud 1,44 m ² | 86584 |

| Unifloor ondervloerplaten | Artikelnr. |
|---|------------|
|  Thermofelt (verlijmd) tapijt Dikte 7,5 mm Inhoud 9,13 m ² | 86559 |
|  Marathon Super XPS losliggend vinyl, 10 dB PVC (plak) Dikte 7 mm Inhoud 5,309 m ² | 86575 |
|  Marathon Premium XPS PVC, (klik) PVC, tapijttegels Dikte 8 mm Inhoud 4,424 m ² | 86599 |
|  Renoboard zwevende installatie laminaat en parket Dikte 9 mm Inhoud 0,96 m ² | 86589 |
|  Jumpax Acoustic 10 dB laminaat, lamelparket, PVC, vinyl, linoleum en tapijt (verlijmd) Dikte 18 mm Inhoud 0,72 m ² | 86536 |
|  Jumpax Basic/Heatpak PVC, linoleum, kurk Dikte 7 mm Inhoud 2,88 m ² | 86568 |
|  Jumpax Classic (original dual) linoleum, PVC (plak) 10 dB Dikte 10 mm Inhoud 2,88 m ² | 86564 |
|  Jumpax HD linoleum, (verlijmd) PVC 10 dB, projecttoepassing Dikte 10 mm Inhoud 2,88 m ² | 86576 |
|  Jumpax Nature linoleum, PVC en vinyl op houten draagvloeren Dikte 14,5 mm Inhoud 2,16 m ² | 86578 |
|  Jumpax Strong lvt, linoleum, 13dB Dikte 16,5 mm Inhoud 0,72 m ² | 86548 |

2.2 ZWEVENDE ONDERVLOEREN (vervolg)

Unifloor ondervloerplaten



Heatpak Plus 86149
PVC, linoleum,
tapijt (verlijmd)

Dikte 7 mm
Inhoud 1,44 m²



Jumpax Prefab
10 dB contactgeluidreducerend
ondervloersysteem
voor 11 mm prefab tapis

Dikte 18,5 mm
**Let op! Bestaat uit twee
gecombineerde producten.**

86578 & 86590



Jumpax Heat Isolator
Geluidsreducerend ondervloer-
systeem voor vinyl, linoleum,
PVC en tapijt op elektrische
vloerverwarming

Dikte 13 mm
**Let op! Bestaat uit twee
gecombineerde producten.**

86568 & 86811



**Jumpax Heat
Traditional**
Geluidsreducerend ondervloer-
systeem voor vinyl, linoleum,
PVC stroken en tapijt op
traditionele vloerverwarming
en/of vloerkoeling.

Dikte 8,2 mm
**Let op! Bestaat uit twee
gecombineerde producten.**

86568 & 86141



**Redu-panel met
Cocofloor 29 mm**
10 dB oplossing voor zowel 6 als
9 mm massief parket en 20 mm
multiplank, vol verlijmd.

Dikte 25 mm
**Let op! Bestaat uit twee
gecombineerde producten.**

86584 & 86590

Unifloor productbox

Artikelnr.



Jumpax Box 86538



Unifloor Box 86539

Estillon ondervloerplaten

Artikelnr.



**Black square
+ 10 dB laminaat** 86640
laminaat, lamelparket,
duoplank, massieve
plank 20 mm

Dikte 5 mm
Inhoud 7,41 m²



Floorfixx regular 86638
PVC zelfklevend,
linoleum, tapijt
(verlijmd)

Dikte 9 mm
Inhoud 2,88 m²



Floorfixx comfort 86639
lamelparket, PVC
zelfklevend, linoleum,
tapijt (verlijmd)

Dikte 10 mm
Inhoud 2,88 m²



Floorfixx optimum 86637
PVC (verlijmd)

Dikte 8 mm
Inhoud 2,80 m²



Floorfixx fini 86635
PVC (klik), verend vinyl
(los en verlijmd),
tapijt (verlijmd)

Dikte 8 mm
Inhoud 5,015 m²

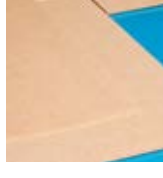

Floorfixx smart 86636
PVC zelfklevend,
tapijt (verlijmd)

Dikte 8 mm
Inhoud 2,80 m²

Hardboard

Artikelnr.



Hardboard plaat 86649
61x122 cm

Dikte 3,2 mm

Unifloor EcoPearls

Artikelnr.



Ecopearls egalisatie 86566

Inhoud 18,5 kg



**EcoFleece
dampdoorlatende
onderlaag** 86588

Inhoud 60 m²

Vochtwerende folie

Artikelnr.



**Diffufol
vochtwerende folie
SD-waarde >150m** 86120

Inhoud 30 m²
1x30 m



**Diffufol
vochtwerende folie
SD-waarde >100m** 86122

Inhoud 50 m²
2x25 m gevouwen



PPC
ONDERVLOEREN
ZOEKER

SCAN DE QR-CODE

Scan, vind en bestel!

**VIND IN
5 STAPPEN
DE JUISTE
ONDERVLOER**

ZOEK, VIND EN BESTEL!

Het kiezen van een geschikte ondervloer is niet altijd eenvoudig. Twijfel je over de juiste ondervloer? Maak dan gebruik van onze ondervloerenzoeker. In slechts vijf stappen worden de ondervloeren gefilterd die passen bij de vloer.

Hoe werkt de ondervloerenzoeker?

Scan de QR-code en doorloop de 5 stappen!

- 1 Ondergrond**
Om welke ondergrond gaat het?
- 2 Vloerverwarming/koeling**
Ga je vloerverwarming/koeling installeren?
- 3 Type vloer**
Selecteer het type vloer dat je gaat leggen.
- 4 Soort vloer**
Selecteer de specifieke soort vloer.
- 5 Gebruikstoepassing**
Selecteer de specifieke toepassing waarin je de vloer en ondervloer gaat gebruiken.

24/7 Bereikbaar en
altijd up to date!

plintenenprofielcentrale.nl/ondervloerenzoeker

2.3 LEGMATERIALEN

| Tape | Artikelnr. |
|--|------------|
|  Ondervloerentape 86121 Lengte 50 m Breedte 50 mm | |
|  Tape universeel weekmakerbestendig 82751 Voor tapijt/vinyl Per 36 Lengte 25 m | |
|  Renoboard tape 86598 Lengte 50 m Breedte 50 mm | |
|  Ducttape grijs 92219 Lengte 50 m Breedte 48 mm | |
|  Quick-Step Zelfklevend plakband voor ondervloeren 09216 Lengte 50 m Breedte 50 mm | |

| Messen | Artikelnr. |
|---|------------|
|  Delphin mes inclusief houder 85212 | |
|  Pajarito reservemes 19 mm rond 85245 10 stuks | |
|  Pajarito reservemes 19 mm hoekhaak 85242 10 stuks | |
|  Pajarito reservemes 19 mm trapezium 85246 10 stuks | |
|  Pajarito reservemes 19 mm haak 85247 10 stuks | |
|  Reserve rechte messen RB UBA-10 85561 10 stuks | |











| Messen | Artikelnr. |
|---|------------|
|  Reserve haakmessen UBH 85563 10 stuks | |
|  Afbreekmes kunststof klein 85568 13 cm | |
|  Reserve afbreekmessen standaard RB BK-18 85567 10 stuks | |
|  Reservemes afbreekmessen standaard SBA9-10 85562 10 stuks | |
|  TIP! Meer gereedschappen zijn te vinden in hoofdstuk 9: Gereedschap of kijk in onze webshop. | |

| Overig | Artikelnr. |
|---|------------|
|  Kantstrook 86580 Lengte 120 cm Breedte 45 mm | |
|  Unifloer kantband 86586 Lengte 10 meter | |

3. LIJMEN & KIT

| | | |
|------------|------------------------|-----------|
| 3.1 | THOMSIT | 36 |
| 3.2 | STAUF | 36 |
| 3.3 | BONA | 37 |
| 3.4 | KERAKOLL | 37 |
| 3.5 | WAKOL | 37 |
| 3.7 | KITTEN | 38 |
| 3.7.1 | PPC | 38 |
| 3.7.2 | SOUDAL | 38 |
| 3.7.3 | STAUF | 38 |
| 3.8 | KITTEN OP KLEUR | 39 |
| 3.9 | TOEBEHOREN | 40 |
| 3.9.1 | LIJMKAMMEN/SPATELS | 40 |
| 3.9.2 | MIXERS EN ROERSTAVEN | 41 |
| 3.9.3 | HANDSCHOENEN | 41 |
| 3.9.4 | REINIGINGSDOEKJES | 41 |
| 3.9.5 | LIJM/KITPISTOLEN | 41 |



3.1 THOMSIT

| Thomsit Parket | | Inhoud | Artikelnr. |
|---|--|--------|------------|
|  | P618 dispersielijm licht 800-1.400 gram per m ² | 15 kg | 96560 |
|  | P625 2K PU-parketlijm 1.000-1.700 gram per m ² | 8 kg | 96565 |
|  | P670 Elast parketlijm 700-1.200 gram per m ² | 18 kg | 96573 |
|  | P680 Elast strong parketlijm 700-1.200 gram per m ² | 18 kg | 96578 |
|  | P690 Strong parketlijm 700-1.200 gram per m ² | 18 kg | 96579 |
| Thomsit PVC | | Inhoud | Artikelnr. |
|  | K188E PVC lijm Aquaplast 250-300 gram per m ² | 13 kg | 96594 |
|  | BasicBond Universele PVC dispersielijm 320-480 gram per m ² | 12 kg | 96562 |
|  | K145 rolfixatie voor PVC stroken Ca. 100 gram per m ² | 10 kg | 96595 |
|  | K190F vezelversterkte PVC- en rubberlijm 220-300 gram per m ² | 13 kg | 96597 |
| Thomsit Tapijt/Linoleum | | Inhoud | Artikelnr. |
|  | TL280 Combi tapijt en linoleum 350-650 gram per m ² | 15 kg | 96591 |
|  | UK840 universele vloerbedekkingslijm 300-440 gram per m ² | 14 kg | 96598 |

3.2 STAUF

| Stauf Parket | | Inhoud | Artikelnr. |
|---|--|---------------|----------------|
|  | Dispersielijm licht M2A-700 850-1.200 gram per m ² | 18 kg | 96421 |
|  | 2K PU-lijm licht PUK 446 1.000-1.300 gram per m ² | 9 kg | 96437 |
|  | Polymeerlijm licht SMP 930 1.000-1.300 gram per m ² | 18 kg | 96451 |
|  | SPU-570 parketlijm (weekmakervrij) 1.000-1.900 gram per m ² | 8 kg 18 kg | 96412 96413 |
|  | SPU-460E hard 1K parketlijm Kleur wengé Ca. 100 gram per m ² | 18 kg | 96449 |
|  | SPU 425 montageijm (20 stuks) Ca. 600 gram per m ² | 600 ml | 96445 |
|  | Nadenlijm | 750 gr | 96458 |
|  | Holle plekken vuller Repamed | 50 ml | 96460 |
|  | Speciaalreiniger voor parket Voor het verwijderen van verse vlekken van polyurethaan- of oplosmiddellijmen op afgewerkte parketvloeren | 750 ml | 96427 |
| Stauf PVC | | Inhoud | Artikelnr. |
|  | D37 PVC (contact)lijm 200-325 gram per m ² | 14 kg | 96416 |
|  | D50 vezelversterkte PVC-lijm Ca. 300 gram per m ² | 14 kg | 96417 |
| Stauf Tapijt/linoleum | | Inhoud | Artikelnr. |
|  | D8 linoleumlijm Ca. 400 gram per m ² | 14 kg | 96424 |
| Stauf Overig | | Inhoud | Artikelnr. |
|  | Extreme Tack dispersie montageijm Ca. 1.000-1.500 gram per m ² | 3,5 kg | 96471 |

3.3 BONA

| Bona Parket | Kleur | Inhoud | Artikelnr. |
|--|------------------------------------|-------------------------|-------------------------|
|  Titan silaanlijm 850-1.500 gram per m ² | Licht | 15 kg | 96776 |
|  Quantum T parketlijm 850-1.500 gram per m ² | Eiken/ beige | 15 kg | 96770 |
|  Quantum parketlijm 850-1.500 gram per m ² | Eiken/ beige | 15 kg | 96772 |
|  R848T silaanlijm 850-1.250 gram per m ² | Licht | 7 kg | 96800 |
| Kleurpigment | Kleur | Inhoud | Artikelnr. |
|  Mixol kleurpigment voor lijm 20 ml/7 kg lijm Geschikt voor lijmen van Thomsit en Bona | Donkerbruin Zwart Steengrijs | 20 ml 20 ml 20 ml | 96761 96762 96763 |

3.4 KERAKOLL

| Kerakoll Parket | Kleur | Inhoud | Artikelnr. |
|--|-----------------|----------------|----------------|
|  SLC 2K Lijm Eco L34 Evolution 800-1.500 gram per m ² | Licht Donker | 10 kg 10 kg | 96666 96665 |
|  SLC 2K Lijm Eco L34 Rapid snellijm 800-1.500 gram per m ² | Licht Licht | 5 kg 10 kg | 96639 96638 |
|  SLC L34 Hybrid 700-1.300 gram per m ² | Licht | 16 kg | 96641 |
|  SLC Eco B3 nadenlijm Ca. 30 gram per meter | Kleurloos | 500 ml | 96645 |
| Kerakoll PVC | Kleur | Inhoud | Artikelnr. |
|  SLC R3 Plus | Eiken/beige | 5 kg 18 kg | 96684 96685 |

3.5 WAKOL

| Wakol Parket | Inhoud | Artikelnr. |
|---|---------|------------|
|  D 1640 dispersielijm 700-1.300 gram per m ² | 14 kg | 77086 |
|  2K PU 216 850-1.550 gram per m ² | 7,75 kg | 77129 |
|  PU 225 2K lijm 800-1.200 gram per m ² | 6,75 kg | 77076 |
|  2K PU 225 projekt parketlijm 800-1.500 gram per m ² | 10 kg | 77077 |
|  MS 228 kant en klaar parketlijm 800-1.500 gram per m ² | 18 kg | 77080 |
|  MS 230 polymeerlijm 800-1.400 gram per m ² | 18 kg | 77072 |
|  MS 260 800-1.400 gram per m ² | 18 kg | 77081 |
| Wakol PVC | Inhoud | Artikelnr. |
|  D 3320 PVC dispersielijm 250-450 gram per m ² | 12 kg | 77130 |
|  D 3125 PVC dispersielijm 190-220 gram per m ² | 10 kg | 77144 |

3.7 KITTEN

3.7.1 PPC

| PPC | Kleur | Inhoud | Artikelnr. |
|---|-------------------|--------|------------|
|  | Wit | 290 ml | 96828 |
|  | Zwart RAL 9005 | 290 ml | 96827 |
|  | Wit | 290 ml | 16200 |
|  | Wit | 290 ml | 91769 |

Montagekit afgestemd op jouw huisstijl, PPC maakt het mogelijk!



Wij ontwerpen voor jou een unieke signing, printen deze en voorzien de producten van dit gepersonaliseerde etiket. **Eigen private label onderhoudsartikelen** zijn te vinden in hoofdstuk 8: Onderhoud

TIP!

3.7.2 SOUDAL

| | Kleur | Inhoud | Artikelnr. |
|---|--------------|------------------|----------------|
|  | Wit | 290 ml | 96830 |
|  | Wit | 290 ml | 96834 |
|  | Transparant | 290 ml | 96833 |
|  | Beige | 310 ml | 84054 |
|  | Wit Zwart | 310 ml 310 ml | 96840 96841 |
|  | Transparant | 290 ml | 96832 |

Soudal lijmen

| | Inhoud | Artikelnr. |
|---|--------|------------|
|  | 3 gr | 84050 |
|  | 50 gr | 97910 |

Overig

| | Inhoud | Artikelnr. |
|---|---------|------------|
|  | 5 stuks | 84051 |
|  | 5 stuks | 84052 |

3.7.3 STAUF

| Stauf | Inhoud | Artikelnr. |
|---|--------|------------|
|  | 290 ml | 96459 |

3.8 KITTEN OP KLEUR

ColorSealant koker 310 ml Artikelnr.

| | | | |
|----------------------|-----------------|--|-------|
| Wit eiken | CS4201 | | 84101 |
| Eiken | CS4204 | | 84104 |
| Beuken | CS4206 | | 84106 |
| Eiken polar | CS4210 | | 84110 |
| Zwart | CS4212 | | 84112 |
| Eiken wit geolied | CS4215 | | 84115 |
| Midden grijs | CS4216 | | 84116 |
| Donkergrijs RAL 7016 | CS4218 | | 84142 |
| Midden eiken | CS4222 | | 84122 |
| Licht rustiek eiken | CS4229 | | 84129 |
| Transparant grijs | CS4233 | | 84133 |
| Warm bruin | CS4235 | | 84135 |
| Noten | CS4236 | | 84136 |
| Rustiek eiken | CS4239 | | 84139 |
| Wengé | CS4240 | | 84140 |
| Wit | RAL 9010 CS5241 | | 84141 |
| Wit | RAL 9016 CS4242 | | 84107 |



ColorSealant monsterstalenkaart 99910

Bona Gap Master koker 310 ml Artikelnr.

| | | | |
|---------------------|---------|--|-------|
| Eiken licht | | | 84501 |
| Eiken donker | | | 84502 |
| Gerookt eiken | | | 84503 |
| Beuken donker | | | 84504 |
| Beuken licht | | | 84505 |
| Ahorn | | | 84506 |
| Kersen | | | 84507 |
| Essen | | | 84508 |
| Teak | | | 84509 |
| Rood exotisch | | | 84510 |
| Noten | | | 84511 |
| Wengé / Panga Panga | | | 84512 |
| Zwart | | | 84513 |
| Wit | | | 84514 |
| Grijs | RAL7030 | | 84515 |





Bona Gapmaster monsterstalenkaart 99909

Soudal siliconenkit koker 310 ml Artikelnr.



| | | | |
|---------------------------|----------|--|-------|
| Transparant | | | 84041 |
| Transparant grijs/trijs | | | 84042 |
| Beige | RAL 1001 | | 84001 |
| Zandgeel | RAL 1002 | | 84002 |
| Bruinbeige | RAL 1011 | | 84003 |
| Parelwit | RAL 1013 | | 84004 |
| Ivoor | RAL 1014 | | 84005 |
| Licht ivoor | RAL 1015 | | 84006 |
| Grijsbeige | RAL 1019 | | 84007 |
| Olijfgrijs | RAL 7002 | | 84017 |
| Beige grijs | RAL 7006 | | 84018 |
| IJzer grijs | RAL 7011 | | 84019 |
| Basalt grijs | RAL 7012 | | 84020 |
| Leigrijs | RAL 7015 | | 84021 |
| Antraciet | RAL 7016 | | 84022 |
| Zwartgrijs | RAL 7021 | | 84023 |
| Schaduw grijs | RAL 7022 | | 84024 |
| Steen grijs | RAL 7030 | | 84025 |
| Kiezel grijs | RAL 7032 | | 84026 |
| Lichtgrijs | RAL 7035 | | 84027 |
| Kwart grijs | RAL 7039 | | 84028 |
| Zijdegrijs | RAL 7044 | | 84029 |
| Kleibruin | RAL 8003 | | 84031 |
| Reebruin | RAL 8007 | | 84032 |
| Sepi bruin | RAL 8014 | | 84033 |
| Chocoladebruin | RAL 8017 | | 84034 |
| Bleekbruin | RAL 8025 | | 84036 |
| Diepzwart | RAL 9005 | | 84037 |
| Crème wit | RAL 9001 | | 84038 |
| Wit | RAL 9010 | | 84039 |
| Verkeerswit | RAL 9016 | | 84040 |
| Soudal monsterstalenkaart | | | 84000 |

3.9 TOEBEHOREN

3.9.1 LIJKAMMEN/SPATELS



| Lijmspatel voor banden/stroken | Afmeting | Artikelnr. |
|--|----------|------------|
|  F850 gram B3 Fijn (F850) | 6 cm | 92148 |
|  G1000 gram B10 Grof (G1000) | 6 cm | 92149 |

| PPC Lijmkam fijn | Afmeting | Artikelnr. |
|--|----------------|----------------|
|  A2 (fijn) voor PVC 250 gram | 18 cm 25 cm | 92142 92143 |
|  18 cm breed B2 | 18 cm | 92147 |
|  F850 gram B3 | 18 cm 25 cm | 92151 92175 |
|  F1000 gram B8 | 18 cm 25 cm | 92161 92176 |
|  F1250 gram B14 | 18 cm | 92171 |

| PPC Lijmkam grof | Afmeting | Artikelnr. |
|---|----------------|----------------|
|  G850 gram B6 | 18 cm | 92152 |
|  G1000 gram B10 | 18 cm 25 cm | 92162 92177 |
|  G1250 gram B16 | 18 cm 25 cm | 92172 92178 |

| Overige lijkammen | Artikelnr. |
|---|------------|
|  Lijmkam A1 (zeer fijn) | 92141 |
|  Lijmkam nr 4 voor SLC lijmen 1400 gram | 96628 |
|  Bona Trowel Plus lijkam voor Quantum | 96696 |



| Stauf Lijmkam fijn | Artikelnr. |
|--|------------|
|  Stauf lijkam Nr. 1 (A2) | 96475 |

| Stauf Lijmkam grof | Artikelnr. |
|--|------------|
|  Stauf lijkam Nr. 4 (B15) | 96478 |
|  Stauf lijkam Nr. 14 | 96485 |



3.9.2 MIXERS EN ROERSTAVEN

| | Artikelnr. |
|---|--|
|  | Roerstaaf voor mixen (PU) lijmen 92140 |
|  | Verfmixer 85x400 mm 92320 |



3.9.3 HANDSCHOENEN

| | Maat | Artikelnr. |
|---|------------|------------|
|  | Maat 9/M | 92295 |
| | Maat 10/L | 92296 |
| | Maat 11/XL | 92297 |
|  | L | 92305 |
| | XL | 92306 |

3.9.4 REINIGINGSDOEKJES

| | Aantal | Artikelnr. |
|---|-----------|------------|
|  | 90 stuks | 92209 |
|  | 150 stuks | 98995 |

3.9.5 LIJM/KITPISTOLEN

| Gereedschap | Artikelnr. |
|---|--------------------------------|
|  | Kitpistool professioneel 84192 |
|  | Stauf kitpistool 600 ml 96444 |



GUNSTIGE RETOUR- REGELING



DENNIS, LUUK EN DAAN ZORGEN VOOR JE RETOUREN

Zij krijgen de retouren binnen, checken ze en geven dit door aan onze binnendienst. Als alles in orde is, wordt voor retour gegeven goederen, doorgaans, het volledige aankoopbedrag teruggegeven zonder aftrek van kosten. Als één team zorgen wij ervoor dat je retour vakkundig wordt afgehandeld.

Wist je dat de retourservice van PPC gratis is? In de meeste gevallen kan je de bestelde goederen gewoon retourneren.

We hebben drie retouropties:

- 1. Retouren op locatie**
- 2. Retouren terugbrengen naar een filiaal**
- 3. Ophalen van de retouren op je eigen adres**

Wist je dat bij retouren op locatie de consument een mailtje ontvangt met daarin het tijdvak waarin de artikelen worden opgehaald? De consument hoeft er dus niet de hele dag voor thuis te blijven. Dit is de extra service die hoort bij onze gunstige retourregeling. Alles voor het gemak van de klant!

4. VLOEREN

| | | |
|-------------|--------------------------------|-----------|
| 4.1 | DOUWES DEKKER® | 44 |
| 4.1.1 | DOUWES DEKKER® LAMINAAT | 46 |
| 4.1.2 | DOUWES DEKKER® PVC | 48 |
| 4.2 | SENSE | 52 |
| 4.3 | ASPECTA | 58 |
| 4.4 | PRIVATE LABEL | 66 |
| 4.4.1 | LAMINAAT. | 66 |
| 4.4.2 | PVC. | 68 |
| 4.4.3 | HDF-PVC. | 70 |
| 4.5 | QUICK•STEP | 72 |
| 4.6 | HOLLANDSCHE VLOEREN® | 74 |
| 4.7 | BAUWERK PARKETT | 78 |
| 4.8 | WARM BY BAUWERK PARKETT | 80 |
| 4.8.1 | VISGRAAT | 81 |
| 4.8.2 | PLANK | 81 |
| 4.9 | BOEN | 82 |
| 4.10 | EUROPEES EIKEN DUOPLANK | 86 |



 PROBEER DE
 ROOMDESIGNER
 SCAN DE QR-CODE

HAAL DOUWES DEKKER IN HUIS MET DE ROOMDESIGNER

Een mooi nieuw interieur begint bij een goede basis, de vloer. Maar hoe bepaal je welke vloer hiervoor de juiste is? De kleur, het materiaal, de houtnerf, een mat of glanzend oppervlak, het heeft allemaal invloed op de sfeer. Plank of Patroon? Betonlook of naturel? Deze en meer vragen zijn met de Roomdesigner goed te beantwoorden.

Naast een aantal standaardkamers is er de mogelijkheid de eigen woonruimte te uploaden en deze vervolgens te voorzien van een vloer naar keus. Met de Douwes Dekker PVC en Laminaat collectie is er een breed scala aan vloeren in de Roomdesigner beschikbaar en dus veel te ontdekken!

Gebruik de Roomdesigner en ontdek welke stijl vloer bij jouw klant past!

Douwes Dekker® Ambitieux / Hongaarse punt boterkoek



4.1 DOUWES DEKKER®

Douwes Dekker® is hét onderscheidende merk voor de beste laminaat en PVC-vloeren. De decoren in de collectie sluiten perfect aan op de trends van het moment, maar hebben ook een uitgebreide keuze aan klassieke hardlopers. Smaken verschillen en dat is bij een vloer natuurlijk net zo. Daarom is er een collectie met een grote diversiteit. Veel tekening in de houtnerf, voelbare steenstructuur of juist een rustig decor. Kies één decor door het hele huis maar leg verschillende patronen. Een brede plank voor op de slaapkamer en een visgraat in de woonkamer. De stuk voor stuk trendy vloeren zijn allemaal geschikt voor vloerverwarming en -koeling! Douwes Dekker® is altijd op voorraad bij PPC, de **unieke 4-uurs garantie** geldt dus ook voor deze vloeren!

DOUWES DEKKER® LAMINAAT

De collectie Douwes Dekker® laminaat bevat voor ieder wat wils. Iedere vloer heeft zijn eigen karakter en stijl met specifieke kenmerken: stoer of strak, robuust of elegant, ingetogen of overdadig, modern of romantisch. Zonder vellingkant of juist met 2- of 4-zijdige vellingkant, net wat de klant zoekt. Laminaatvloeren worden zwevend gelegd, raadpleeg de ondervloerenzoeker op onze webshop voor het vinden van de juiste ondervloer. In slechts vijf stappen worden de geschikte ondervloeren gefilterd.

DOUWES DEKKER® PVC

Zoveel keus in zorgeloos PVC! Of je nu op zoek bent naar een hout-, steen- of betonlook, visgraat of hongaarse punt, Douwes Dekker heeft het allemaal. Het assortiment van de Douwes Dekker PVC-collectie is met de 30 verschillende vloeren, in zowel plak als klik bijzonder compleet en biedt vele voordelen. Alle vloeren zijn dankzij de 0,55 mm slijtlaag 'zorgeloze' onderhoudsvriendelijke vloeren met het grootste gebruiksgemak. Door de watervaste constructie zijn deze vloeren ook ideaal voor het gebruik in natte ruimtes als de keuken en badkamer. Hierdoor laat je óók deze ruimtes naadloos aansluiten bij de rest van het interieur!



OOK DEALER WORDEN?

NEEM CONTACT OP MET JE VERTEGENWOORDIGER!

Presentatie is alles! Daarom heeft Douwes Dekker een uitgebreid palet aan presentatiemogelijkheden. Van een fraaie PVC- en laminaatdisplay tot volledig shop-in-shop concept. Om de verkoop in jouw showroom te stimuleren heeft Douwes Dekker verschillende marketing tools in de markt gezet. Zo is er een GRATIS inspiratie magazine te bestellen en kan de klant gemakkelijk middels de Roomdesigner iedere vloer virtueel bekijken in een (eigen) ruimte. Ook kun je gebruik maken van de unieke sampleservice, de consumenten worden hiermee naar de dealers verwezen om samples op te halen, zo zijn ze meteen op het juiste adres! Daarnaast zijn alle dealers te vinden in de dealerlocator op de Douwes Dekker website.







4.1.1 DOUWES DEKKER LAMINAAT

SPONTAAN PLANK

| | | | | | |
|--|---|---|--|---|---|
|  |  |  |  |  |  |
| Plank gember 04949 | Plank saffraan 04950 | Plank dille 04951 | Plank dragon 04952 | Plank nootmuskaat 04953 | Plank tijm 04954 |

| Legsysteem | Vellingkant | Lengte | Breedte | Dikte | Oppervlakte | Verpakking | RC waarde | Gebruiksklasse | Garantie |
|------------|-------------|----------|---------|-------|-------------|----------------------|--------------------------|----------------|----------|
| Uniclic | Geen | 126,1 cm | 19,2 cm | 7 mm | Soft touch | 2,421 m ² | 0,051 m ² K/W | 23/32 (AC4) | 15 jaar |

SYMPATHIEK BREDE PLANK

| | | | |
|--|---|---|--|
|  |  |  |  |
| Brede plank kamille 05037 | Brede plank koriander 05038 | Brede plank peterselie 05039 | Brede plank rozemarijn 05040 |

| Legsysteem | Vellingkant | Lengte | Breedte | Dikte | Oppervlakte | Verpakking | RC waarde | Gebruiksklasse | Garantie |
|------------|-------------|----------|---------|-------|-------------|---------------------|-------------------------|----------------|----------|
| Safe-Lock | 2V | 128,5 cm | 24,3 cm | 8 mm | Embossed | 2,19 m ² | 0,048m ² K/W | 23/32 (AC4) | 20 jaar |

TROTS PLANK - WATERBESTENDIG

| | | | |
|--|---|---|--|
|  |  |  |  |
| Solide plank laurier 04682 | Solide plank salie 04683 | Solide plank marjolein 04684 | Solide plank kervel 04685 |

| Legsysteem | Vellingkant | Lengte | Breedte | Dikte | Oppervlakte | Verpakking | RC waarde | Gebruiksklasse | Garantie |
|------------|-------------|----------|---------|-------|-------------|----------------------|-------------------------|----------------|----------|
| Uniclic | 4V | 126,1 cm | 19,2 cm | 8 mm | Embossed | 2,179 m ² | 0,055m ² K/W | 23/32 (AC4) | 20 jaar |

KRACHTIG BREDE PLANK - WATERBESTENDIG

| | | | |
|--|---|---|--|
|  |  |  |  |
| Solide brede plank oregano 04686 | Solide brede plank kerrie 04687 | Solide brede plank kruidnagel 04689 | Solide brede plank mosterd 04690 |

| Legsysteem | Vellingkant | Lengte | Breedte | Dikte | Oppervlakte | Verpakking | RC waarde | Gebruiksklasse | Garantie |
|------------|-------------|----------|---------|-------|-------------|-----------------------|-------------------------|----------------|----------|
| Uniclic | 4V | 126,1 cm | 24,4 cm | 8 mm | Embossed | 2,4615 m ² | 0,055m ² K/W | 23/32 (AC4) | 20 jaar |



4.1.1 DOUWES DEKKER LAMINAAT (vervolg)

OPGEWEKT PLANK

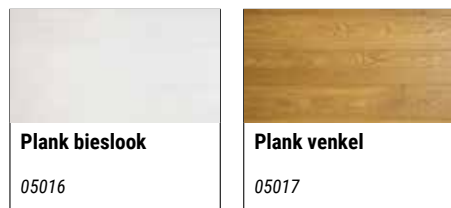

| Legsysteem | Vellingkant | Lengte | Breedte | Dikte | Oppervlakte | Verpakking | RC waarde | Gebruiksklasse | Garantie |
|------------|-------------|----------|---------|-------|-------------|----------------------|--------------------------|----------------|----------|
| Uniclic | 2V | 126,1 cm | 19,2 cm | 8 mm | Embossed | 2,179 m ² | 0,055 m ² K/W | 23/32 (AC4) | 20 jaar |

ENTHOUSIAST TEGEL



| Legsysteem | Vellingkant | Lengte | Breedte | Dikte | Oppervlakte | Verpakking | RC waarde | Gebruiksklasse | Garantie |
|------------|-------------|---------|---------|-------|----------------|----------------------|--------------------------|----------------|----------|
| Safe-lock | 4V | 85,3 cm | 40 cm | 8 mm | Steenstructuur | 1,706 m ² | 0,048 m ² K/W | 23/32 (AC4) | 25 jaar |

ELEGANT LANGE BREDE PLANK



| Legsysteem | Vellingkant | Lengte | Breedte | Dikte | Oppervlakte | Verpakking | RC waarde | Gebruiksklasse | Garantie |
|------------|-------------|--------|---------|-------|-------------|----------------------|--------------------------|----------------|----------|
| Safe-lock | 4V | 220 cm | 24,3 cm | 9 mm | Embossed | 2,673 m ² | 0,053 m ² K/W | 23/32 (AC4) | 25 jaar |

GALANT VISGRAAT



| Legsysteem | Vellingkant | Lengte | Breedte | Dikte | Oppervlakte | Verpakking | RC waarde | Gebruiksklasse | Garantie |
|------------|-------------|---------|---------|-------|-------------|----------------------|--------------------------|----------------|----------|
| HDF-klik | 4V | 85,3 cm | 14,3 cm | 8 mm | Embossed | 1,595 m ² | 0,048 m ² K/W | 23/32 (AC4) | 25 jaar |

4.1.2 DOUWES DEKKER PVC





PRAKTISCH PLANK

| | | | |
|--|---|---|--|
|  |  |  |  |
| Plank kletskep | Plank wafel | Plank sprits | Plank biscuit |
| Klik⁽¹⁾ 04876 | Klik⁽¹⁾ 04877 | Klik⁽¹⁾ 04878 | Klik⁽¹⁾ 04879 |
| Plak⁽²⁾ 04736 | Plak⁽²⁾ 04737 | Plak⁽²⁾ 04738 | Plak⁽²⁾ 04739 |

| Legsysteem | Vellingkant | Lengte | Breedte | Dikte | Slijtlaag | Oppervlakte | Verpakking | RC waarde | Gebruiksklasse | Garantie |
|------------|-------------|-----------|----------|--------|-----------|---------------|----------------------|--------------------------|----------------|------------|
| (1) Klik | 4mv | 121 cm | 22 cm | 5,2 mm | 0,55 mm | Houtstructuur | 2,662 m ² | 0,051 m ² K/W | 23/33 | 15/10 jaar |
| (2) Plak | 4mv | 121,92 cm | 22,86 cm | 2,5 mm | 0,55 mm | Houtstructuur | 3,34 m ² | 0,017 m ² K/W | 23/33 | 15/10 jaar |





4 AMBITIEUS RIANTE PLANK

| | | | | | |
|--|---|---|--|---|---|
|  |  |  |  |  |  |
| Riante plank nougat | Riante plank stroop | Riante plank drop | Riante plank honing | Riante plank pepermint | Riante plank zoethout |
| Klik⁽¹⁾ 04847 | Klik⁽¹⁾ 04848 | Klik⁽¹⁾ 04849 | Klik⁽¹⁾ 04850 | Klik⁽¹⁾ 04851 | Klik⁽¹⁾ 04852 |
| Plak⁽²⁾ 04740 | Plak⁽²⁾ 04741 | Plak⁽²⁾ 04742 | Plak⁽²⁾ 04743 | Plak⁽²⁾ 04744 | Plak⁽²⁾ 04745 |

| | | | | |
|--|---|---|--|---|
|  |  |  |  |  |
| Riante plank gemberkoek | Riante plank bastogne koek | Riante plank boterkoek | Riante plank spekkoeke | Riante plank peperkoek |
| Klik⁽¹⁾ 04867 | Klik⁽¹⁾ 04868 | Klik⁽¹⁾ 04869 | Klik⁽¹⁾ 04870 | Klik⁽¹⁾ 04871 |
| Plak⁽²⁾ 04726 | Plak⁽²⁾ 04727 | Plak⁽²⁾ 04728 | Plak⁽²⁾ 04729 | Plak⁽²⁾ 04730 |

| Legsysteem | Vellingkant | Lengte | Breedte | Dikte | Slijtlaag | Oppervlakte | Verpakking | RC waarde | Gebruiksklasse | Garantie |
|------------|-------------|----------|----------|--------|-----------|-------------|---------------------|--------------------------|----------------|------------|
| (1) Klik | 4mv | 151 cm | 22 cm | 7,5 mm | 0,55 mm | Embossed | 2,66 m ² | 0,088 m ² K/W | 23/33 | 15/10 jaar |
| (2) Plak | 4mv | 152,4 cm | 22,86 cm | 2,5 mm | 0,55 mm | Embossed | 3,48 m ² | 0,017 m ² K/W | 23/33 | 15/10 jaar |

AMBITIEUS VISGRAAT

| | | | | |
|--|---|---|--|---|
|  |  |  |  |  |
| Trendy visgraat caramel | Trendy visgraat salmiak | Trendy visgraat kaneel | Trendy visgraat honing | Trendy visgraat gemberkoek |
| Klik⁽¹⁾ 04856 | Klik⁽¹⁾ 04857 | Klik⁽¹⁾ 04858 | Klik⁽¹⁾ 04859 | Klik⁽¹⁾ 04969 |
| Plak⁽²⁾ 04753 | Plak⁽²⁾ 04754 | Plak⁽²⁾ 04755 | Plak⁽²⁾ 04756 | Plak⁽²⁾ 04731 |
| Plak plank⁽³⁾ 04757 | Plak plank⁽³⁾ 04758 | Plak plank⁽³⁾ 04759 | Plak plank⁽³⁾ 04743 | Plak plank⁽³⁾ 04726 |

| Legsysteem | Vellingkant | Lengte | Breedte | Dikte | Slijtlaag | Oppervlakte | Verpakking | RC waarde | Gebruiksklasse | Garantie |
|------------|-------------|----------|----------|--------|-----------|-------------|---------------------|--------------------------|----------------|------------|
| (1) Klik | 4mv | 72 cm | 12 cm | 7 mm | 0,55 mm | Embossed | 2,07 m ² | 0,088 m ² K/W | 23/33 | 15/10 jaar |
| (2) Plak | 4mv | 76,2 cm | 15,24 cm | 2,5 mm | 0,55 mm | Embossed | 2,79 m ² | 0,017 m ² K/W | 23/33 | 15/10 jaar |
| (3) Plak | 4mv | 152,4 cm | 22,8 cm | 2,5 mm | 0,55 mm | Embossed | 3,48 m ² | 0,017 m ² K/W | 23/33 | 15/10 jaar |

(3) Te gebruiken als band bij visgraat

4.1.2 DOUWES DEKKER PVC (vervolg)

AMBITIEUS BREDE VISGRAAT

| | | | |
|---|---|---|--|
|  |  |  |  |
| Brede visgraat boterkoek | Brede visgraat spekkoek | Brede visgraat honing | Brede visgraat pepermint |
| Klik⁽¹⁾ 04872 | Klik⁽¹⁾ 04873 | Klik⁽¹⁾ 04874 | Klik⁽¹⁾ 04875 |
| Plak⁽²⁾ 04732 | Plak⁽²⁾ 04733 | | Plak⁽²⁾ 04764 |
| Plak plank⁽³⁾ 04728 | Plak plank⁽³⁾ 04729 | | Plak plank⁽³⁾ 04744 |





| Legsysteem | Vellingkant | Lengte | Breedte | Dikte | Slijtlaag | Oppervlakte | Verpakking | RC waarde | Gebruiksklasse | Garantie |
|------------|-------------|----------|----------|--------|-----------|-------------|----------------------|--------------------------|----------------|------------|
| (1) Klik | 4mv | 72 cm | 18 cm | 7 mm | 0,55 mm | Embossed | 2,074 m ² | 0,088 m ² K/W | 23/33 | 15/10 jaar |
| (2) Plak | 4mv | 76,2 cm | 15,24 cm | 2,5 mm | 0,55 mm | Embossed | 2,79 m ² | 0,017 m ² K/W | 23/33 | 15/10 jaar |
| (3) Plak | 4mv | 152,4 cm | 22,86 cm | 2,5 mm | 0,55 mm | Embossed | 3,48 m ² | 0,017 m ² K/W | 23/33 | 15/10 jaar |

AMBITIEUS HONGAARSE PUNT

| | |
|--|--|
|  |  |
| Hongaarse punt boterkoek | Hongaarse punt spekkoek |
| Klik⁽¹⁾ 04967 | Klik⁽¹⁾ 04968 |
| Plak⁽²⁾ 04734 | Plak⁽²⁾ 04735 |



| Legsysteem | Vellingkant | Lengte | Breedte | Dikte | Slijtlaag | Oppervlakte | Verpakking | RC waarde | Gebruiksklasse | Garantie |
|------------|-------------|--------|---------|--------|-----------|-------------|----------------------|--------------------------|----------------|------------|
| (1) Klik | 4mv | 70 cm | 14 cm | 8 mm | 0,55 mm | Embossed | 2,156 m ² | 0,088 m ² K/W | 23/33 | 15/10 jaar |
| (2) Plak | 4mv | 70 cm | 15,5 cm | 2,5 mm | 0,55 mm | Embossed | 3,82 m ² | 0,017 m ² K/W | 23/33 | 15/10 jaar |

AMBITIEUS TEGEL

| | | | |
|---|---|---|--|
|  |  |  |  |
| Flinke tegel bitterkoek | Flinke tegel muffin | Flinke tegel macaron | Flinke tegel brownie |
| Klik⁽¹⁾ 04863 | Klik⁽¹⁾ 04864 | Klik⁽¹⁾ 04865 | Klik⁽¹⁾ 04866 |
| Plak⁽²⁾ 04760 | Plak⁽²⁾ 04761 | Plak⁽²⁾ 04762 | Plak⁽²⁾ 04763 |

| Legsysteem | Veilingkant | Lengte | Breedte | Dikte | Slijtlaag | Oppervlakte | Verpakking | RC waarde | Gebruiksklasse | Garantie |
|------------|-------------|----------|----------|--------|-----------|----------------|----------------------|--------------------------|----------------|------------|
| (1) Klik | 4mv | 90,6 cm | 44,8 cm | 8,5 mm | 0,55 mm | Steenstructuur | 2,435 m ² | 0,088 m ² K/W | 23/33 | 15/10 jaar |
| (2) Plak | 4mv | 91,44 cm | 45,72 cm | 2,5 mm | 0,55 mm | Steenstructuur | 3,34 m ² | 0,017 m ² K/W | 23/33 | 15/10 jaar |

4.1 DOUWES DEKKER® (vervolg)

| Handwaaiers | Artikelnr. | Handwaaiers | Artikelnr. | Promotiemateriaal | Artikelnr. |
|--|---------------------------------|---|---|---|-----------------------|
|  | Laminaat |  | PVC |  | Magazine 04995 |
| | Enthousiast tegels 04997 | | Ambitieuus verlijmd - riante plank 1 04970 | | |
| | Galant visgraat 04998 | | Ambitieuus verlijmd - visgraat en hongaarse punt 04972 | | |
| | Spontaan 04999 | | Ambitieuus tegels 04974 | | |
| | Elegant 05113 | | Ambitieuus klik - brede visgraat 04975 | | |
| | Opgewekt 05126 | | Ambitieuus klik - hongaarse punt 04976 | | |
| | Sympathiek 05128 | | Ambitieuus klik - riante plank 2 04977 | | |
| | Trots 05230 | | Ambitieuus klik - riante plank 1 04882 | | |
| | Krachtig 05231 | | Ambitieuus klik-visgraat 04884 | | |
| | | | Ambitieuus verlijmd - riante plank 2 04885 | | |
| | | | Praktisch verlijmd - planken 04996 | | |

VLOERONDERHOUD

Douwes Dekker® heeft eigen onderhoudsproducten voor het onderhoud van de laminaat en PVC-vloeren. De Douwes Dekker® laminaat en PVC-reiniger is vormgegeven in de Douwes Dekker®-huisstijl waarmee de vloer onderhoudsartikelen goed bij het merk passen en perfect bij de verkoop van de vloeren aansluiten.

De artikelen zijn per doos en per fles te bestellen.



Laminaatreiniger
1 liter, 91777



PVC reiniger
1 liter, 91776



4

4.2 SENSE

Op zoek naar een veelzijdig en compleet merk voor luxe PVC-vloeren? Sense biedt hoogwaardige comfortabele vloeren met de uitstraling van echt hout of natuursteen. **Betrouwbaar, geluiddempend, watervast, duurzaam en milieuvriendelijk.** De kwaliteit van de afwerking en de zuivere samenstelling zijn belangrijke pijlers van Sense. Dankzij de verschillende legwijzes is er voor iedere toepassing een passende vloer.

De Sense-collectie heeft, met **50 verschillende decoren**, voor iedere woonstijl het bijpassende decor. Liefhebbers van een klassieke stijl komen helemaal aan bod met de keus uit verschillende hout decoren in bijvoorbeeld visgraatpatroon. De tegels in natuursteen decoren passen daarentegen weer perfect bij een stoere strakke woonstijl en zijn leverbaar in diverse formaten tot wel 91,4 x 91,4 cm. De vloeren zijn voorzien van een unieke supermatte afwerking met een glansgraad van 3, waardoor ze bijna niet van echt hout en steen te onderscheiden zijn. De vloeren uit de **klik-series G, F en W** hebben een **geïntegreerde ondervloer** waarmee **10 dB geluidsreductie** wordt gerealiseerd. Ideaal voor appartementen dus!

De vloeren uit de **Sense-collectie zijn op voorraad** bij PPC, de unieke 4-uurs garantie geldt dus ook voor deze vloeren!



OOK DEALER WORDEN? NEEM CONTACT OP MET JE VERTEGENWOORDIGER!

Als Sense-dealer profiteer je van mooie voordelen. Ondersteuning met fraai displaymateriaal, handwaaiers en architectenmappen. Sense heeft een uitgebreide consumentenwebsite waarop de consument alles over de vloeren, decoren en voordelen van Sense kan terugvinden. Als dealer wordt je vermeld op de site, zodat potentiële klanten je snel weten te vinden.

Daarnaast kan de consument hier stalen bestellen die zij vervolgens bij jou kunnen afhalen. Zo maken we de verkoop zo gemakkelijk mogelijk!



UNIEKE ASPECTEN

SUPER MAT

Bijna alle vloeren zijn voorzien van een SUPER MAT finish. Deze afwerking zorgt voor een nog natuurlijkere uitstraling.

10 DB GELUISREDUCTIE

De click-vloeren hebben een geïntegreerde ondervloer met 10 dB geluidsreductie, ideaal voor appartementen!

BREDE COLLECTIE

Ongekend brede collectie: 52 decoren, 120 vloeropties, in een compacte presentatie.

ZEER SLIJTVAST

Extra sterke toplaag door PUR-behandeling. Deze afwerking zorgt voor een nog natuurlijkere uitstraling.

ZUIVERE SAMENSTELLING

De vloeren van Sense zijn voorzien van een REACH-zuiverheidscertificaat. Omdat er uitsluitend gebruik wordt gemaakt van biologische weekmakers, zijn de vloeren bovendien 100% ftalaatvrij.

Sense / PVC • Beton T809 • Hout VL905
www.sensepvcvloeren.nl

P-Serie
PP-Serie



V-Serie

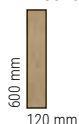

VL-Serie XL

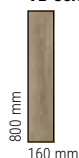

T-Serie

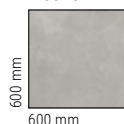

X-Serie

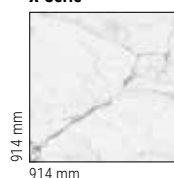

F-Serie

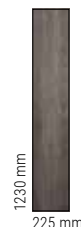



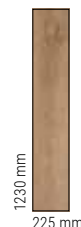















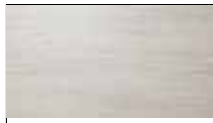







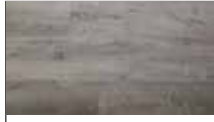
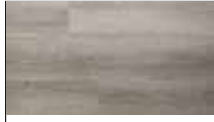

G-Serie



W-Serie



HOUT















| | | | | | |
|---|---|--|---|---|--|
|  <p>170 DEEP WOOD Dryback P 02106 SPC Rigid F 02183</p> |  <p>290 DEEP WOOD Dryback P 02111 SPC Rigid G 02164</p> |  <p>300 LIGHT WOOD Dryback P 02112 SPC Rigid G 02165</p> |  <p>350 LIGHT WOOD Dryback P 02115 SPC Rigid F 02186</p> |  <p>380 DEEP WOOD Dryback P 02117 Dryback VL 02219 SPC Rigid G 02166</p> |  <p>390 DEEP WOOD SPC Rigid F 02187</p> |
|  <p>480 LIGHT WOOD Dryback P 02120</p> |  <p>600 DEEP WOOD Dryback P 02121</p> |  <p>610 DEEP WOOD Dryback P 02122</p> |  <p>680 LIGHT WOOD Dryback P 02126</p> |  <p>700 DEEP WOOD Dryback P 02127</p> |  <p>710 DEEP WOOD Dryback P 02128 SPC Rigid G 02167</p> |
|  <p>750 DEEP WOOD Dryback P 02131</p> |  <p>760 DEEP WOOD Dryback P 02132</p> |  <p>770 DEEP WOOD Dryback P 02133 SPC Rigid G 02168</p> |  <p>790 DEEP WOOD SPC Rigid F 02188</p> |  <p>870 DEEP WOOD Dryback P 02136</p> |  <p>900 DEEP WOOD Dryback P 02209 Dryback VL 02217 SPC Rigid G 02226</p> |
|  <p>905 DEEP WOOD Dryback P 02208 Dryback VL 02216 SPC Rigid G 02227</p> |  <p>910 DEEP WOOD Dryback P 02210</p> |  <p>915 DEEP WOOD Dryback P 02211 Dryback VL 02218 SPC Rigid G 02220</p> |  <p>920 DEEP WOOD Dryback P 02232 Dryback VL 02245 SPC Rigid G 02256</p> |  <p>925 DEEP WOOD Dryback P 02233 Dryback V 02241 SPC Rigid G 02257</p> |  <p>930 DEEP WOOD Dryback P 02234 SPC Rigid G 02258</p> |
|  <p>935 DEEP WOOD Dryback P 02235 Dryback VL 02246 SPC Rigid G 02259</p> |  <p>940 DEEP WOOD Dryback P 02236</p> |  <p>945 DEEP WOOD Dryback P 02237 Dryback V 02242</p> |  <p>950 DEEP WOOD Dryback P 02238 Dryback V 02243 SPC Rigid G 02260</p> |  <p>955 DEEP WOOD Dryback P 02239 Dryback V 02244 SPC Rigid G 02261</p> |  <p>960 DEEP WOOD Dryback P 02240</p> |

| LVT collectie | Vellingkant | Afmeting | Dikte | Toplaag | Verpakking | Verbinding | RC waarde | Gebruiksklasse | Garantie |
|------------------|-------------|-----------------|--------|---------|---------------------|----------------------------------|--------------------------|----------------|----------|
| DRYBACK | | | | | | | | | |
| P | 4MV | 22,86x121,92 cm | 2,5 mm | 0,55 mm | 3,34 m ² | N.v.t. | 0,025 m ² K/W | 23/33 (AC5) | 25 jaar |
| PP (EIR)* | 4MV | 22,86x121,92 cm | 2,5 mm | 0,55 mm | 3,34 m ² | N.v.t. | 0,025 m ² K/W | 23/33 (AC5) | 25 jaar |
| T | 4MV | 60x60 cm | 2,5 mm | 0,55 mm | 2,16 m ² | N.v.t. | 0,025 m ² K/W | 23/33 (AC5) | 25 jaar |
| X | geen | 91,4x91,4 cm | 2,5 mm | 0,55 mm | 5,01 m ² | N.v.t. | 0,025 m ² K/W | 23/33 (AC5) | 25 jaar |
| VL | 4MV | 16x80 cm | 2,5 mm | 0,55 mm | 2,05 m ² | N.v.t. | 0,025 m ² K/W | 23/33 (AC5) | 25 jaar |
| V (EIR)* | 4MV | 12x60 cm | 2,5 mm | 0,55 mm | 2,02 m ² | N.v.t. | 0,025 m ² K/W | 23/33 (AC5) | 25 jaar |
| SPC RIGID | | | | | | | | | |
| F | 4MV | 123x22,5 cm | 4,7 mm | 0,55 mm | 2,21 m ² | Traditioneel (Uniclic/Twincllic) | 0,06 m ² K/W | 23/33 (AC5) | 25 jaar |
| G | 4MV | 123x22,5 cm | 6,5 mm | 0,55 mm | 2,21 m ² | Traditioneel (Uniclic/Twincllic) | 0,06 m ² K/W | 23/33 (AC5) | 25 jaar |
| G (EIR)* | 4MV | 123x22,5 cm | 6,5 mm | 0,55 mm | 2,21 m ² | Traditioneel (Uniclic/Twincllic) | 0,06 m ² K/W | 23/33 (AC5) | 25 jaar |
| W | 4MV | 45x90 cm | 6,5 mm | 0,55 mm | 2,03 m ² | Traditioneel (Uniclic/Twincllic) | 0,06 m ² K/W | 23/33 (AC5) | 25 jaar |

*EIR staat voor Embossed in Register. Bij Embossed in Register past de structuur van de toplaag precies op de tekening in de filmlaag. Hierdoor voel je ook wat je ziet, bijvoorbeeld bij knoesten. Net als bij echt hout, zo heeft de PVC vloer een nog realistischer uitstraling!











4.2 SENSE (vervolg)

HOUT

| | | | | | |
|---|--|--|--|---|---|
|  E10 Dryback PP 02138 Dryback V 02154 SPC Rigid G 02169 |  E15 Dryback PP 02139 SPC G 02170 |  E20 Dryback PP 02140 |  E25 Dryback PP 02141 Dryback V 02155 SPC Rigid G 02171 |  E30 Dryback PP 02142 Dryback V 02156 SPC Rigid G 02172 |  E35 Dryback PP 02143 Dryback V 02157 SPC Rigid G 02173 |
|  E40 Dryback PP 02144 Dryback V 02158 SPC Rigid G 02174 |  E45 SPC Rigid G 02175 |  E50 SPC Rigid G 02176 |  E55 Dryback PP 02145 Dryback V 02159 SPC Rigid G 02177 |  E60 Dryback PP 02213 |  E65 Dryback PP 02214 SPC Rigid G 02221 |
|  E70 Dryback PP 02215 |  E80 Dryback PP 02212 | | | | |

4

TEGELS

| | | | | | |
|--|--|--|---|--|--|
|  801 SANDSTONE Dryback T 02146 SPC Rigid W 02178 |  803 SANDSTONE Dryback T 02147 Dryback X 02160 SPC Rigid W 02179 |  806 SANDSTONE Dryback T 02150 Dryback X 02228 SPC Rigid W 02229 |  807 SANDSTONE Dryback T 02151 Dryback X 02161 SPC Rigid W 02180 |  808 SANDSTONE Dryback T 02152 Dryback X 02162 SPC Rigid W 02181 |  809 SANDSTONE Dryback T 02153 Dryback X 02163 SPC Rigid W 02182 |
|  820 SANDSTONE Dryback T 02248 Dryback X 02252 SPC Rigid W 02262 |  821 SANDSTONE Dryback T 02249 Dryback X 02253 SPC Rigid W 02263 |  830 SANDSTONE Dryback T 02250 Dryback X 02254 SPC Rigid W 02264 |  831 SANDSTONE Dryback T 02251 Dryback X 02255 SPC Rigid W 02265 | | |

4.2 SENSE (vervolg)

| Handwaaiers | Artikelnr. | Monsterboek | Artikelnr. | Promotiemateriaal | Artikelnr. |
|---|--|---|--|---|----------------------------------|
|  | Handwaaijer Sense visgraat V 02284 |  | Sense monsterboek 2 wit/grijs/taupe tinten 02192 |  | Sense tegel display 02190 |
|  | Handwaaijer Sense grote visgraat VL 02283 |  | Sense monsterboek 1 EIR decoren geel/bruin tinten 02191 |  | Sense luxedisplay 02282 |
| | |  | Sense monsterboek 3T serie, staal SPC, ondervloer 02193 |  | Sense folder 02195 |

DUURZAAMHEID

REACH-CERTIFICAAT

Door de zuivere samenstelling voldoen alle vloeren van Sense aan het REACH (Registratie, Evaluatie en Autorisatie van Chemische stoffen) certificaat.

GEPRODUCEERD MET ISO 9001 & ISO 14001

Sense streeft naar kwaliteitsbewustwording in alle facetten van het bedrijf. De vloeren zijn conform het ISO 9001 & ISO 14001 certificaat geproduceerd.

100% FTALAATVRIJ

Bij Sense wordt gebruik gemaakt van een biologische weekmaker op basis van sojaabonolie. Dit is een ftalaat vervanger. Hierdoor gebruikt Sense geen ftalaten.

RECYCLEBAAR

PVC vloeren worden milieuvriendelijk geproduceerd en deze zijn na gebruik volledig recyclebaar

VLOERONDERHOUD

Sense heeft een eigen onderhoudsproduct voor het onderhoud van de PVC-vloeren! De Sense PVC-reiniger is vormgegeven in de Sense-huisstijl waarmee het onderhoudsartikel goed bij het merk past en perfect bij de verkoop van de vloeren aansluit.

De artikelen zijn per doos en per fles te bestellen.



PVC reiniger
1 liter, 91775



HAAL SENSE IN HUIS MET DE ROOMDESIGNER

Uitgekeken op het interieur gaan veel mensen op zoek naar inspiratie. Een mooi nieuw interieur begint bij een goede basis, de vloer. Maar hoe bepaal je welke vloer hiervoor de juiste is? De kleur, het materiaal, de houtnerf, een mat of glanzend oppervlak, het heeft allemaal invloed op de sfeer. Plank of Patroon? Betonlook of naturel? Deze en meer vragen zijn met de Roomdesigner goed te beantwoorden.

Naast een aantal standaardkamers is er de mogelijkheid de eigen woonruimte te uploaden en deze vervolgens te voorzien van een vloer naar keus. Met de Sense PVC collectie is er een breed scala aan vloeren in de Roomdesigner beschikbaar en dus veel te ontdekken!

Gebruik de Roomdesigner en ontdek welke stijl vloer bij jouw klant past!

Sense / PVC • Visgraat E30





4

Aspecta / Bolsena

ASPECTA EXCELLENCE

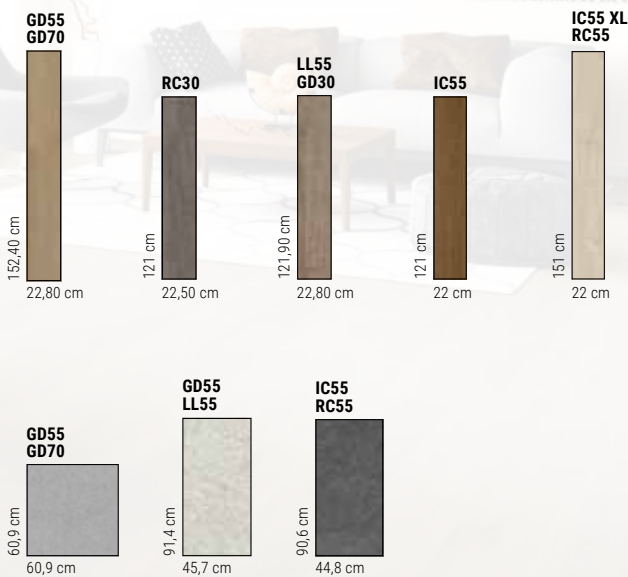

ASPECTA CONTOURS

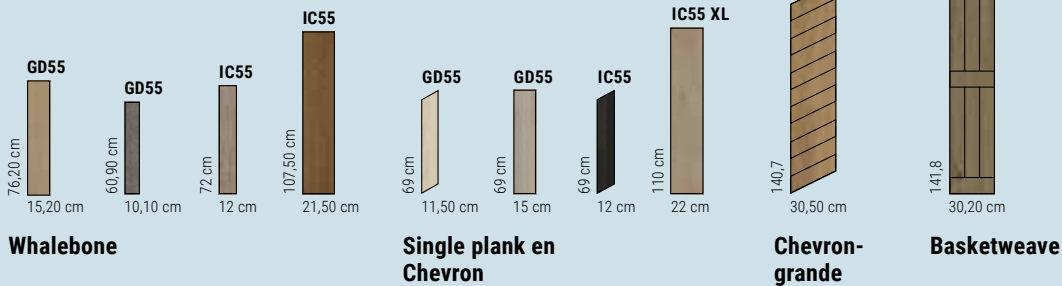

Aspecta / Baron

ASPECTA ESSENTIALS

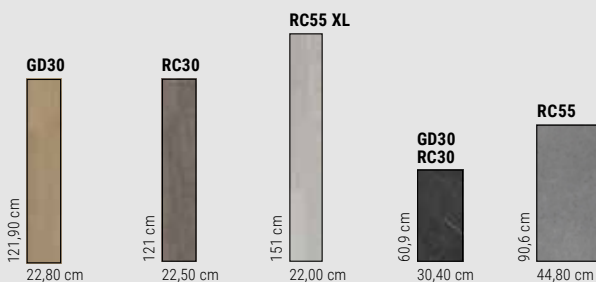

4.3 ASPECTA

HMTX Global behoort met haar merk Aspecta wereldwijd tot de top twee grootste producenten van LVT/PVC- vinylvloeren en heeft hun Europese verkoophoofdkantoor gevestigd in Nederland. Het van origine Amerikaanse bedrijf is een specialist in LVT/PVC vloeren en maken eigentijdse vloeren. Ze beschikken over een ruime ervaring op dit gebied en brengen een uitgebreide range aan producten van uitzonderlijke kwaliteit, superieur ontwerp en kleur, evenals unieke afwerking, duurzaamheid en veiligheid. Bijna alle decoren zijn In-register embossed ("IRE"), wat inhoudt dat tekening en structuur in de plank gelijklopen, voor een levensecht effect. Alle LVT-producten zijn phtalaat-vrij en beschikken over een PU afwerking met ingestrooide keramische deeltjes, de zogenaamde Duraspect coating.

COLLECTIE

De Aspecta collectie bestaat uit **225 posities, en is verkrijgbaar in dryback-, Rigid Core Click- (SPC) en Isocore-Click (EPC) en Loose-Lay LVT-uitvoeringen.** Met ruim 80 items direct uit voorraad leverbaar bij PPC, en de overige collectie direct vanuit het grote centrale Aspecta magazijn in Roosendaal, zorgen we er altijd voor dat alles snel geleverd kan worden. Met Aspecta bedienen we zowel de residentiële als de commerciële markt.

ASPECTA VOOR DE TOEKOMST

Speciale aandacht voor veilige en duurzame productie, transparantie wat betreft productingrediënten en productieomstandigheden zorgen ervoor dat Aspecta vloeren voldoen aan de hoogste Europese kwaliteitsnormen. Daardoor dragen ze bij aan veilige en gezonde interieurs. Alle Aspecta vloeren worden doormiddel van state-of-the-art productietechnologieën vervaardigd. Aspecta's JUST label certificaat waarborgt dat alle 1.600 productiemedewerkers in goede handen zijn, op het gebied van veiligheid, diversiteit, arbeidsvoorwaarden en betrokkenheid bij de gemeenschap. Aspecta is trots op zijn eigen duurzaamheidsstrategie, waar de LEED- en Green Globes-gecertificeerde gebouwen een goed voorbeeld van zijn.

DUURZAAMHEID

Aspecta beschikt over verschillende duurzaamheidscertificaten zoals een 'Indoor Air Comfort GOLD', Dit certificaat toont aan dat de vloeren van Aspecta bijdragen aan een gezond milieu in huis. Met de lancering van de 2 nieuwste carbon-neutrale collecties, Excellence en Contours draagt Aspecta z'n steentje bij aan het behoud van de wereld.



4

OOK DEALER WORDEN?

NEEM CONTACT OP MET JE VERTEGENWOORDIGER!

Als Aspecta-dealer profiteer je van mooie voordelen. Ondersteuning met fraai displaymateriaal, handwaaiers en architectenmappen. Aspecta heeft een uitgebreide consumentenwebsite waarop de consument alles over de vloeren, decoren en voordelen van Aspecta kan terugvinden. Als dealer wordt je vermeld op de site, zodat potentiële klanten je snel weten te vinden. Daarnaast kan de consument hier stalen bestellen die zij vervolgens bij jou kunnen afhalen. Zo maken we de verkoop zo gemakkelijk mogelijk!

PRESENTATIEMOGELIJKHEDEN

Aspecta heeft verschillende presentatiemogelijkheden. Zo is er een set van 3 architectenboeken beschikbaar. Voor de collecties zijn er displays en een brochure.

WEBSITE



























Ook is er een state-of-the-art website waar alles te vinden is. Zo is hier een roomvisualiser te vinden waar je de Aspecta vloer kan bekijken in de ruimte naar keuze. Ook bestel je hier gemakkelijk een sample naar keuze en uiteraard is er ook een dealer locator op te vinden.

4-UURS GARANTIE

PPC biedt een unieke 4-uurs garantie op vloeren. Doet zich een probleem voor? Dan leveren wij binnen 4 uur vervangend materiaal op de werkvloer! Zo kan je snel weer door.

www.aspectaflooring.com





EXCELLENCE SINGLE PLANK

| | | | | | |
|---|--|---|--|---|---|
|  <p>Albano GD55 29615 IC55 XL 29653</p> |  <p>Almond GD55 29632 GD70 29697 LL55 29707 IC55 29605 IC55 XL 29668</p> |  <p>Baron GD55 29627 GD70 29701 LL55 29711 IC55 29604 IC55 XL 29663</p> |  <p>Bolsena GD55 29614 IC55 XL 29652</p> |  <p>Brienz GD55 29617 IC55 XL 29655</p> |  <p>Burned GD55 29634 GD70 29699 LL55 29709 IC55 XL 29670</p> |
|  <p>Colonial Oak Honey IC55 29602</p> |  <p>Como GD55 29612 IC55 XL 29650</p> |  <p>Constance GD55 29616 IC55 XL 29654</p> |  <p>Elegant GD55 29626 GD70 29700 LL55 29710 IC55 29603 IC55 XL 29662</p> |  <p>Lomond GD55 29621 IC55 XL 29657</p> |  <p>Lugano GD55 29620 IC55 XL 29656</p> |
|  <p>Macadamia GD55 29633 GD70 29698 LL55 29708 IC55 29606 IC55 XL 29669</p> |  <p>Maggiore GD55 29619 IC55 XL 29649</p> |  <p>Milk GD55 29629 GD70 29694 LL55 29704 IC55 XL 29665</p> |  <p>Mushroom GD55 29630 GD70 29695 LL55 29705 IC55 29607 IC55 XL 29666</p> |  <p>Omega GD55 29618 IC55 XL 29648</p> |  <p>Pecan GD55 29631 GD70 29696 LL55 29706 IC55 XL 29667</p> |
|  <p>Pepper GD55 29625 IC55 XL 29661</p> |  <p>Prespa GD55 29613 IC55 XL 29651</p> |  <p>Ridge Oak Silver IC55 29601</p> |  <p>Oak Grey IC55 29600</p> |  <p>Rye GD55 29623 IC55 XL 29659</p> |  <p>Salt GD55 29624 IC55 XL 29660</p> |
|  <p>Savannah GD55 29622 IC55 XL 29658</p> |  <p>Throne GD55 29628 IC55 XL 29664</p> | | | | |

| Single plank | Legwijze | Vellingkant | Lengte | Breedte | Dikte | Verpakking | Verbinding | Gebruiksklasse | Garantie |
|--------------|-----------|-------------|----------|---------|--------|----------------------|---------------------|----------------|------------|
| GD55 | Verlijmd | 4V | 152,4 cm | 22,8 cm | 2,5 mm | 3,484 m ² | Geen | 23/42 | 10/20 jaar |
| GD70 | Verlijmd | 4V | 152,4 cm | 22,8 cm | 3,2 mm | 3,34 m ² | Geen | 23/42 | 10/20 jaar |
| LL55 | Loose-lay | 4V | 121,9 cm | 22,8 cm | 5 mm | 1,95 m ² | N.v.t. | 23/33 | 10/20 jaar |
| IC55 | Zwevend | 4V | 121 cm | 22 cm | 6,3 mm | 1,86 m ² | Droplock / dropdown | 23/33 | 10/20 jaar |
| IC55 XL | Zwevend | 4V | 151 cm | 22 cm | 8 mm | 2,658 m ² | Droplock / dropdown | 23/33 | 10/20 jaar |
| IC55 XXL | Zwevend | 4V | 182,8 cm | 22 cm | 8 mm | 2,41 m ² | Droplock / dropdown | 23/33 | 10/20 jaar |

4.3 ASPECTA (vervolg)

EXCELLENCE SINGLE PLANK

| | | | | |
|---|---|---|--|---|
|  |  |  |  |  |
| Anna IC55 XXL 29689 | Madelyn IC55 XXL 29685 | Maxima IC55 XXL 29688 | Penelope IC55 XXL 29686 | Sophie IC55 XXL 29687 |











EXCELLENCE TILES

| | | | | | |
|---|---|---|--|---|---|
|  |  |  |  |  |  |
| Shimmerhead GD55 29636 GD70 29702 LL55 29716 IC55 29676 | Copperhead GD55 29637 GD70 29703 LL55 29717 IC55 29677 | Empire GD55 29608 GD70 29690 LL55 29712 IC55 29671 | Flatiron GD55 29609 GD70 29691 LL55 29713 IC55 29672 | Grace GD55 29611 GD70 29693 LL55 29715 IC55 29674 | Rockefeller GD55 29610 GD70 29692 LL55 29714 IC55 29673 |
|  |  |  |  |  |  |
| Cameo GD55 29639 IC55 29684 | Choy GD55 29638 IC55 29683 | Pearl GD55 29635 IC55 29675 | Cloud GD55 29640 IC55 29678 | Carbon GD55 29641 IC55 29680 | Champagne GD55 29643 IC55 29682 |
|  |  | | | | |
| Magna GD55 29644 IC55 29679 | Mist GD55 29681 IC55 29642 | | | | |

| Tiles | Legwijze | Vellingkant | Lengte | Breedte | Dikte | Verpakking | Verbinding | Gebruiksklasse | Garantie |
|-------|-----------|-------------|---------|---------|--------|---------------------|---------------------|----------------|------------|
| GD55 | Verlijmd | 4V | 60,9 cm | 60,9 cm | 2,5 mm | 3,34 m ² | Geen | 23/42 | 10/20 jaar |
| GD55 | Verlijmd | 4V | 91,4 cm | 45,7 cm | 2,5 mm | 3,34 m ² | Geen | 23/42 | 10/20 jaar |
| GD70 | Verlijmd | 4V | 60,9 cm | 60,9 cm | 3,2 mm | 3,34 m ² | Geen | 23/42 | 10/20 jaar |
| LL55 | Loose-lay | 4V | 91,4 cm | 45,7 cm | 5 mm | 1,95 m ² | N.v.t. | 23/33 | 10/20 jaar |
| IC55 | Zwevend | 4V | 90,6 cm | 44,8 cm | 8 mm | 1,86 m ² | Droplock / dropdown | 23/33 | 10/20 jaar |



4.3 ASPECTA (vervolg)

CONTOURS WHALEBONE

| | | | | | |
|--|---|---|--|---|---|
|  |  |  |  |  |  |
| Albano | Almond | Bolsena | Brienz | Burned | Carbon |
| GD55 29807 | GD55 29813 | GD55 29806 | GD55 29809 | GD55 29815 | GD55 29862 |
| IC55 29856 | IC55 29859 | IC55 29855 | IC55 29858 | IC55 29861 | IC55 29817 |
|  |  |  |  | | |
| Como | Constance | Macadamia | Mist | | |
| GD55 29805 | GD55 29808 | GD55 29811 | GD55 29819 | | |
| IC55 29854 | IC55 29857 | IC55 29860 | IC55 29863 | | |

4

| Whalebone | Legwijze | Vellingkant | Lengte | Breedte | Dikte | Verpakking | Verbinding | Gebruiksklasse | Garantie |
|-------------|----------|-------------|----------|----------|--------|----------------------|---------------------|----------------|------------|
| GD55 | Verlijmd | 4V | 76,20 cm | 15,20 cm | 2,5 mm | 2,787 m ² | Geen | 23/42 | 10/20 jaar |
| IC55 | Zwevend | 4V | 72,00 cm | 12,00 cm | 8 mm | 2,07 m ² | Droplock / dropdown | 23/33 | 10/20 jaar |

| | | |
|---|--|--|
|  |  |  |
| Danzig | Monarch | Roseway |
| GD55 29645 | GD55 29646 | GD55 29647 |

| Whalebone | Legwijze | Vellingkant | Lengte | Breedte | Dikte | Verpakking | Verbinding | Gebruiksklasse | Garantie |
|-------------|----------|-------------|----------|----------|--------|---------------------|------------|----------------|------------|
| GD55 | Verlijmd | 4V | 60,90 cm | 10,10 cm | 2,5 mm | 2,23 m ² | Geen | 23/42 | 10/20 jaar |

| | | | | | |
|--|---|---|--|---|---|
|  |  |  |  |  |  |
| Chambord Alpin Whale | Chambord Ambre Whale | Chambord Blé Whale | Chambord Bonheur Whale | Chambord Naturel Whale | Chambord Soleil Whale |
| IC55 29823 | IC55 29824 | IC55 29822 | IC55 29821 | IC55 29820 | IC55 29825 |

| Whalebone | Legwijze | Vellingkant | Lengte | Breedte | Dikte | Verpakking | Verbinding | Gebruiksklasse | Garantie |
|-------------|----------|-------------|-----------|----------|-------|---------------------|---------------------|----------------|------------|
| IC55 | Zwevend | 4V | 107,50 cm | 21,50 cm | 8 mm | 1,85 m ² | Droplock / dropdown | 23/33 | 10/20 jaar |









4.3 ASPECTA (vervolg)

CONTOURS SINGLE PLANK, CHEVRON

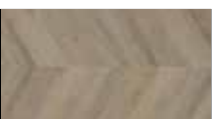
| | | | | | |
|--|---|---|---|--|--|
|  Albano GD55 29802 IC55 29846 |  Almond GD55 29812 IC55 29851 |  Bolsena GD55 29801 IC55 29845 |  Brienz GD55 29804 IC55 29848 |  Burned GD55 29814 IC55 29853 |  Carbon GD55 29816 IC55 29849 |
|  Como GD55 29800 IC55 29844 |  Constance GD55 29803 IC55 29847 |  Macadamia GD55 29810 IC55 29852 |  Mist GD55 29818 IC55 29850 | | |
|  Chantilly Alpin IC55 XL 29827 |  Chantilly Ambre IC55 XL 29828 |  Chantilly Blé IC55 XL 29826 |  Chantilly Rivière IC55 XL 29829 |  Chantilly Soleil IC55 XL 29831 |  Chantilly Terre IC55 XL 29830 |

| Single plank, chevron | Legwijze | Vellingkant | Lengte | Breedte | Dikte | Verpakking | Verbinding | Gebruiksklasse | Garantie |
|-----------------------|----------|-------------|-----------|----------|--------|----------------------|---------------------|----------------|------------|
| GD55 | Verlijmd | 4V | 69,00 cm | 11,50 cm | 2,5 mm | 2,857 m ² | Geen | 23/42 | 10/20 jaar |
| GD55 | Verlijmd | 4V | 69,00 cm | 15,00 cm | 2,5 mm | 2,857 m ² | Geen | 23/42 | 10/20 jaar |
| IC55 | Zwevend | 4V | 69,00 cm | 12,00 cm | 8 mm | 1,822 m ² | Droplock / dropdown | 23/33 | 10/20 jaar |
| IC55 XL | Zwevend | 4V | 110,00 cm | 22,00 cm | 8 mm | 1,94 m ² | Droplock / dropdown | 23/33 | 10/20 jaar |

CONTOURS CHEVRON

| | | | | | |
|---|--|---|---|--|--|
|  Versailles Alpin IC55 29835 |  Versailles Ambre IC55 29836 |  Chantilly Blé IC55 29834 |  Versailles Bonheur IC55 29833 |  Versailles Naturel IC55 29832 |  Versailles Rivière IC55 29837 |
|  Versailles Soleil IC55 29839 |  Versailles Terre IC55 29838 | | | | |













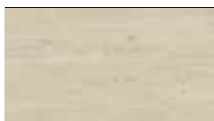









| Chevron | Legwijze | Vellingkant | Lengte | Breedte | Dikte | Verpakking | Verbinding | Gebruiksklasse | Garantie |
|---------|----------|-------------|-----------|----------|-------|---------------------|---------------------|----------------|------------|
| IC55 | Zwevend | 4V | 140,70 cm | 30,50 cm | 8 mm | 1,72 m ² | Droplock / dropdown | 23/33 | 10/20 jaar |

CONTOURS BASKETWEAVE

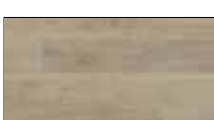
| | | | |
|--|---|---|--|
|  |  |  |  |
| Tarascon Ambre IC55 29842 | Tarascon Blé IC55 29841 | Tarascon Naturel IC55 29840 | Tarascon Rivière IC55 29843 |

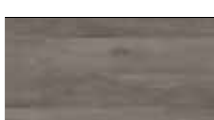
| Basketweave | Legwijze | Vellingkant | Lengte | Breedte | Dikte | Verpakking | Verbinding | Gebruiksklasse | Garantie |
|-------------|----------|-------------|-----------|----------|-------|---------------------|---------------------|----------------|------------|
| IC55 | Zwevend | 4V | 141,80 cm | 30,20 cm | 8 mm | 2,14 m ² | Droplock / dropdown | 23/33 | 10/20 jaar |

ESSENTIALS SINGLE PLANK

| | | | | | |
|--|---|---|--|---|---|
|  |  |  |  |  |  |
| Charm GD30 29506 RC30 29522 | Countess GD30 29501 RC30 29517 | Delight GD30 29500 RC30 29516 | Earl GD30 29507 RC30 29523 | Elegant GD30 29503 RC30 29519 | Impression GD30 29504 RC30 29520 |
|  |  |  |  |  |  |
| Noble GD30 29505 RC30 29521 | Throne GD30 29502 RC30 29518 | Colonial Oak Honey GD30 29510 | Colonial Oak Mauve GD30 29512 | Downing Oak Light GD30 29511 | Ridge Oak Silver GD30 29509 |
|  |  |  |  |  |  |
| Royal Oak Grey GD30 29508 | Albano RC55 XL 29530 | Almond RC55 XL 29537 | Baron RC55 XL 29536 | Bolsena RC55 XL 29529 | Brienz RC55 XL 29532 |
|  |  |  |  |  |  |
| Como RC55 XL 29527 | Constance RC55 XL 29531 | Elegant RC55 XL 29535 | Lomond RC55 XL 29533 | Macadamia RC55 XL 29538 | Prespa RC55 XL 29528 |
|  | | | | | |
| Throne RC55 XL 29534 | | | | | |

| Single plank | Legwijze | Vellingkant | Lengte | Breedte | Dikte | Verpakking | Verbinding | Gebruiksklasse | Garantie |
|--------------|----------|-------------|-----------|----------|--------|---------------------|---------------------|----------------|------------|
| GD30 | Verlijmd | Geen | 121,90 cm | 22,80 cm | 2 mm | 5,57 m ² | Geen | 23/31 | 10/20 jaar |
| RC30 | Zwevend | 4V | 121,00 cm | 22,50 cm | 4,8 mm | 2,18 m ² | Droplock / dropdown | 23/32 | 10/20 jaar |
| RC55 XL | Zwevend | 4V | 151,00 cm | 22,00 cm | 5,2 mm | 1,99 m ² | Droplock / dropdown | 23/34 | 10/20 jaar |

4.3 ASPECTA (vervolg)

ESSENTIALS TILES

| | | | | | |
|---|---|---|--|---|---|
|  |  |  |  |  |  |
| Duchess | Duke | Heir | Grace | Rockefeller | Empire |
| GD30 29515 | GD30 29514 | GD30 29513 | RC55 29542 | RC55 29541 | RC55 29540 |
| RC30 29526 | RC30 29525 | RC30 29524 | | | |
|  | | | | | |
| Flatiron | | | | | |
| RC55 29539 | | | | | |

| Tiles | Legwijze | Vellingkant | Lengte | Breedte | Dikte | Verpakking | Verbinding | Gebruiksklasse | Garantie |
|-------------|----------|-------------|----------|----------|--------|---------------------|---------------------|----------------|------------|
| GD30 | Verlijmd | Geen | 60,90 cm | 30,40 cm | 2 mm | 4,65 m ² | Geen | 23/31 | 10/20 jaar |
| RC30 | Zwevend | 4V | 60,90 cm | 30,40 cm | 4,8 mm | 2,23 m ² | Droplock / dropdown | 23/32 | 10/20 jaar |
| RC55 | Zwevend | 4V | 90,60 cm | 44,80 cm | 5,2 mm | 2,44 m ² | Droplock / dropdown | 23/34 | 10/20 jaar |



4.4 PRIVATE LABEL

4.4.1 LAMINAAT.

LAMINAAT. is een compacte collectie met hoge kwaliteit vloeren voor een vriendelijke prijs. De collectie bestaand uit 16 uniek decoren, onderverdeeld in vier series:

- 7 mm vlak
- 7 mm 4-zijdige vellingkant
- 8 mm pressed bevel 4-zijdige vellingkant
- Extra brede plank 8 mm pressed bevel 4-zijdige vellingkant vlak, met vellingkant of waterbestendig laminaat, voor ieder wat wils!

100% WATERBESTENDIG

De laminaatplanken uit de pressed bevel en de extra brede pressed bevel serie zijn geproduceerd met een nieuwe techniek waardoor het patroon in de vloer doorloopt op de vellingkant. Het vloer oogt dus ontzettend authentiek maar belangrijker nog: hierdoor is de vloer 100% waterbestendig! De zijkanten van de plank zijn met een waterafstotende coating beschermd en sluiten zó strak aan dat water er eenvoudig niet in door kan dringen.

4 LAMINAAT. IN JOUW SHOWROOM?

Bekijk de actuele collectie en de scherpe prijzen in onze webshop en bespreek de mogelijkheden voor de showroom met je vertegenwoordiger.

UNIEKE 4-UURS GARANTIE

PPC biedt een unieke 4 uurs garantie op vloeren: mocht zich een probleem voordoen, dan leveren wij binnen vier uur vervangend materiaal op de werkvloer.

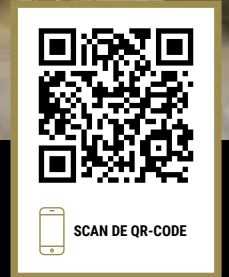

LAMINAAT. ALS PRIVATE LABEL

Altijd al een eigen laminaatvloerenlijn afgestemd op jouw huisstijl willen hebben? PPC maakt het mogelijk! Aan de hand van jouw huisstijl ontwerpen wij een unieke signing en zorgen dat de monsterborden worden voorzien van dit gepersonaliseerde etiket. Resultaat, een krachtige en herkenbare presentatie van een eigen vloerenlijn!

Hoe werkt het? Het is heel eenvoudig!

1. Scan de QR-code
2. Vul het formulier op de website in
3. Upload je logo in drukwerkqualiteit, afgestemd op jouw huisstijl ontwerpen wij vervolgens een gepersonaliseerde etiket.



LAMINAAT. / Natuur eiken geschuurd

4.4.1 LAMINAAT. (vervolg)

DECOREN

| | | | |
|---|---|---|--|
| Eiken vergrijsd ⁽¹⁾ 05076 | Oud eiken licht ⁽¹⁾ 05077 | Laminaat oud eiken donkergrijs geborsteld ⁽²⁾ 05121 | Laminaat oud eiken lichtgrijs geborsteld ⁽²⁾ 05122 |
| Laminaat authentiek eiken naturel ⁽²⁾ 05123 | Laminaat authentiek licht eiken naturel ⁽²⁾ 05124 | Eiken gerookt wit ⁽¹⁾ 05075 | Licht geborsteld eiken ⁽¹⁾ 05078 |

| Promotiemateriaal | Artikelnr. |
|-------------------|---|
| | Handwaaier laminaat 7 mm, klasse 32 05137 |
| | Handwaaier laminaat 7 mm 4V, klasse 32 05125 |
| | Handwaaier laminaat 8 mm 4V, 19,2 cm breed klasse 32 05240 |
| | Handwaaier laminaat 8 mm 4V, 24,4 cm breed klasse 32 05241 |

DECOREN - WATERBESTENDIG

| | | | |
|--|--|---|--|
| Natuur eiken geschuurd ⁽³⁾ 04691 | Charmant eiken natuur ⁽⁴⁾ 04698 | Levendig eiken donker ⁽³⁾ 04692 | Rustiek eiken donker ⁽³⁾ 04693 |
| Levendig eiken licht ⁽³⁾ 04694 | Charmant eiken donkergrijs ⁽⁴⁾ 04695 | Charmant eiken lichtgrijs ⁽⁴⁾ 04696 | Charmant eiken wit ⁽⁴⁾ 04697 |



PRESSED BEVEL



100% WATERBESTENDIG

| Legsysteem | Vellingkant | Lengte | Breedte | Dikte | Verpakking | RC waarde | Gebruiksklasse | Garantie |
|-------------|-------------|----------|---------|-------|-----------------------|--------------------------|----------------|----------|
| (1) Uniclic | Geen | 126,1 cm | 19,2 cm | 7 mm | 2,421 m ² | 0,051 m ² K/W | 32 (AC4) | 15 jaar |
| (2) Uniclic | 4V | 126,1 cm | 19,2 cm | 7 mm | 2,421 m ² | 0,051 m ² K/W | 32 (AC4) | 15 jaar |
| (3) Uniclic | Embossed 4V | 126,1 cm | 19,2 cm | 8 mm | 2,179 m ² | 0,055 m ² K/W | 32 (AC4) | 20 jaar |
| (4) Uniclic | Embossed 4V | 126,1 cm | 24,4 cm | 8 mm | 2,4615 m ² | 0,055 m ² K/W | 32 (AC4) | 20 jaar |

4.4.2 PVC.

PVC. is een compacte collectie van 16 hoogwaardige PVC-vloeren met een natuurgetrouwe hout- en betonlook, welke goed aansluiten bij de huidige vloertrends en de behoeften van de markt, voor een vriendelijke prijs. De PVC. collectie bestaat uit zowel Dyback als Rigid PVC-vloeren en zijn verkrijgbaar in visgraat, planken en tegels.

UNIEKE 4-UURS GARANTIE

PPC biedt een unieke 4 uren garantie op vloeren: mocht zich een probleem voordoen, dan leveren wij binnen vier uur vervangend materiaal op de werkvloer.

HAAL PVC. IN HUIS MET DE ROOMDESIGNER

Een PVC. vloer bij de klant thuis uitproberen om te zien of het past bij het interieur? Dat kan! Bekijk, vergelijk en maak gemakkelijk een juiste keuze welke vloer in de ruimte moet komen met de Roomdesigner. Ga naar de vloer in de webshop, upload een foto van jouw ruimte en kies je dé favoriete PVC. vloer.

PVC. IN JOUW SHOWROOM?

Ben je benieuwd naar de mogelijkheden van de aantrekkelijke PVC. collectie en presentatiemogelijkheden? Neem contact op met jouw vertegenwoordiger!



PVC. ALS PRIVATE LABEL
Altijd al een eigen PVC-vloerenlijn afgestemd op jouw huisstijl willen hebben? PPC maakt het mogelijk! Aan de hand van jouw huisstijl ontwerpen wij een unieke signing en zorgen dat de monsterborden worden voorzien van dit gepersonaliseerde etiket. Resultaat, een krachtige en herkenbare presentatie van een eigen vloerenlijn!

Hoe werkt het? Het is heel eenvoudig!



















1. Scan de QR-code
2. Vul het formulier op de website in
3. Upload je logo in drukwerkqualiteit, afgestemd op jouw huisstijl ontwerpen wij vervolgens een gepersonaliseerde etiket.

| LVT collectie | Vellingkant | Afmeting | Dikte | Toplaag | Verpakking | Verbinding | RC waarde | Gebruiksklasse | Garantie |
|------------------|-------------|-----------------|--------|---------|---------------------|----------------------------------|--------------------------|----------------|----------|
| DRYBACK | | | | | | | | | |
| P | 4MV | 22,86x121,92 cm | 2,5 mm | 0,55 mm | 3,34 m ² | N.v.t. | 0,025 m ² K/W | 23/33 (AC5) | 25 jaar |
| PP (EIR)* | 4MV | 22,86x121,92 cm | 2,5 mm | 0,55 mm | 3,34 m ² | N.v.t. | 0,025 m ² K/W | 23/33 (AC5) | 25 jaar |
| T | 4MV | 60x60 cm | 2,5 mm | 0,55 mm | 2,16 m ² | N.v.t. | 0,025 m ² K/W | 23/33 (AC5) | 25 jaar |
| X | geen | 91,4x91,4 cm | 2,5 mm | 0,55 mm | 5,01 m ² | N.v.t. | 0,025 m ² K/W | 23/33 (AC5) | 25 jaar |
| VL | 4MV | 16x80 cm | 2,5 mm | 0,55 mm | 2,05 m ² | N.v.t. | 0,025 m ² K/W | 23/33 (AC5) | 25 jaar |
| V (EIR)* | 4MV | 12x60 cm | 2,5 mm | 0,55 mm | 2,02 m ² | N.v.t. | 0,025 m ² K/W | 23/33 (AC5) | 25 jaar |
| SPC RIGID | | | | | | | | | |
| F | 4MV | 123x22,5 cm | 4,7 mm | 0,55 mm | 2,21 m ² | Traditioneel (Uniclic/Twincllic) | 0,06 m ² K/W | 23/33 (AC5) | 25 jaar |
| G | 4MV | 123x22,5 cm | 6,5 mm | 0,55 mm | 2,21 m ² | Traditioneel (Uniclic/Twincllic) | 0,06 m ² K/W | 23/33 (AC5) | 25 jaar |
| G (EIR)* | 4MV | 123x22,5 cm | 6,5 mm | 0,55 mm | 2,21 m ² | Traditioneel (Uniclic/Twincllic) | 0,06 m ² K/W | 23/33 (AC5) | 25 jaar |
| W | 4MV | 45x90 cm | 6,5 mm | 0,55 mm | 2,03 m ² | Traditioneel (Uniclic/Twincllic) | 0,06 m ² K/W | 23/33 (AC5) | 25 jaar |

*EIR staat voor Embossed in Register. Bij Embossed in Register past de structuur van de toplaag precies op de tekening in de filmlaag. Hierdoor voel je ook wat je ziet, bijvoorbeeld bij knoesten. Net als bij echt hout, zo heeft de PVC vloer een nog realistischer uitstraling!

4.4.2 PVC. (vervolg)

DECOREN

| | | | |
|--|--|--|---|
|  380 DEEP WOOD Dryback P 02117 Dryback VL 02219 SPC Rigid G 02166 |  390 DEEP WOOD SPC Rigid F 02187 |  900 DEEP WOOD Dryback P 02209 Dryback VL 02217 SPC Rigid G 02226 |  905 DEEP WOOD Dryback P 02208 Dryback VL 02216 SPC Rigid G 02227 |
|  915 DEEP WOOD Dryback P 02211 Dryback VL 02218 SPC Rigid G 02220 |  935 DEEP WOOD Dryback P 02235 Dryback VL 02246 SPC Rigid G 02259 |  945 DEEP WOOD Dryback P 02237 Dryback V 02242 |  555 VISGRAAT Dryback VL 02247 |
|  E10 Dryback PP* 02138 Dryback V* 02154 SPC Rigid G* 02169 |  E25 Dryback PP* 02141 Dryback V* 02171 SPC Rigid G* 02155 |  E30 Dryback PP* 02142 Dryback V* 02156 SPC Rigid G* 02172 |  E40 Dryback PP* 02144 Dryback V* 02158 SPC Rigid G* 02174 |
|  E55 Dryback PP* 02145 Dryback V* 02159 SPC Rigid G* 02177 |  E55 Dryback PP* 02145 Dryback V* 02159 SPC Rigid G* 02177 |  803 SANDSTONE Dryback T 02147 Dryback X 02160 SPC Rigid W 02179 |  806 SANDSTONE Dryback T 02150 Dryback X 02228 SPC Rigid W 02229 |
|  820 SANDSTONE Dryback T 02248 Dryback X 02252 SPC Rigid W 02262 |  821 SANDSTONE Dryback T 02249 Dryback X 02253 SPC Rigid W 02263 | | |

Promotiemateriaal

Artikelnr.



Handwaaiers
merkloos PVC hout
decoren 04798



Handwaaiers
merkloos PVC
tegels 04799

4.4.3 HDF-PVC.

De HDF-PVC. collectie bestaat uit 12 decoren; drie steendecoren in tegelformaat en negen houtdecoren in plankformaat. Deze PVC vloeren met HDF drager zijn extra sterk! De achterzijde van de vloeren is voorzien van een contactgeluid reducerende backing van kurk en door de HDF drager gemakkelijk te installeren. Deze vloeren zijn met een warmteweerstand van 0,088 m² K/W uitermate geschikt voor vloerverwarming en -koeling.

UNIEKE 4-UURS GARANTIE

PPC biedt een unieke 4 uren garantie op vloeren: mocht zich een probleem voordoen, dan leveren wij binnen vier uur vervangend materiaal op de werkvloer.

HAAL HDF-PVC. IN HUIS MET DE ROOMDESIGNER

Een HDF-PVC. vloer bij de klant thuis uitproberen om te zien of het past bij het interieur? Dat kan! Bekijk, vergelijk en maak gemakkelijk een juiste keuze vloer in de ruimte moet komen met de Roomdesigner. Ga naar de vloer in de webshop, upload een foto van jouw ruimte en kies je dé favoriete PVC. vloer.

4

HDF-PVC. IN JOUW SHOWROOM?

Ben je benieuwd naar de mogelijkheden van de aantrekkelijke HDF-PVC. collectie en presentatiemogelijkheden? Neem contact op met jouw vertegenwoordiger!



HDF-PVC. ALS PRIVATE LABEL

Altijd al een eigen HDF-PVC vloerenlijn afgestemd op jouw huisstijl willen hebben? PPC maakt het mogelijk! Aan de hand van jouw huisstijl ontwerpen wij een unieke signing en zorgen dat de monsterborden worden voorzien van dit gepersonaliseerde etiket. Resultaat, een krachtige en herkenbare presentatie van een eigen vloerenlijn!

Hoe werkt het? Het is heel eenvoudig!

1. Scan de QR-code
2. Vul het formulier op de website in
3. Upload je logo in drukwerkqualiteit, afgestemd op jouw huisstijl ontwerpen wij vervolgens een gepersonaliseerde etiket.



HDF-PVC. / Klik bruin eiken

4.4.3 HDF-PVC. (vervolg)

DECOREN

| | | | |
|---|---|--|--|
| <p>HDF-PVC klik Boseik⁽¹⁾ 09901</p> | <p>HDF-PVC klik Boseik gerookt⁽¹⁾ 09902</p> | <p>HDF-PVC klik Uster eiken⁽²⁾ 09903</p> | <p>HDF-PVC klik Cement ijzer⁽³⁾ 09904</p> |
| <p>HDF-PVC klik Betonsteen⁽³⁾ 09905</p> | <p>HDF-PVC klik Leisteek⁽³⁾ 09906</p> | <p>HDF-PVC klik Royaal bruin eiken⁽⁴⁾ 09907</p> | <p>HDF-PVC klik Royaal donker eiken⁽⁴⁾ 09908</p> |
| <p>HDF-PVC klik Royaal grijs eiken⁽⁴⁾ 09909</p> | <p>HDF-PVC klik Royaal licht eiken⁽⁴⁾ 09910</p> | <p>HDF-PVC klik Royaal natuurlijk eiken⁽⁴⁾ 09911</p> | <p>HDF-PVC klik Royaal wit eiken⁽⁴⁾ 09912</p> |

Promotiemateriaal

Artikelnr.



**Handwaaiertje
HDF-PVC.
klik - Deel 1**

09913



**Handwaaiertje
HDF-PVC.
klik - Deel 2**

09914

| Legsysteem | Vellingkant | Lengte | Breedte | Dikte | Oppervlakte | Verpakking | RC waarde | Gebruiksklasse | Garantie |
|-------------|-------------|----------|---------|--------|----------------|----------------------|--------------------------|----------------|----------|
| (1) Uniclic | Geen | 123,5 cm | 23,0 cm | 9,6 mm | Houtstructuur | 1,704 m ² | 0,088 m ² K/W | 32 | 10 jaar |
| (2) Uniclic | Geen | 123,5 cm | 23,0 cm | 10 mm | Houtstructuur | 1,704 m ² | 0,088 m ² K/W | 33 | 10 jaar |
| (3) Uniclic | Geen | 62,0 cm | 45,0 cm | 10 mm | Steenstructuur | 1,674 m ² | 0,088 m ² K/W | 33 | 10 jaar |
| (4) Uniclic | Geen | 123,5 cm | 23,0 cm | 9,8 mm | Embossed | 1,704 m ² | 0,088 m ² K/W | 32 | 10 jaar |

4



Quick-Step® / MUS5485 Gesluisde blauwsteen

4.5 QUICK-STEP

LAMINAATVLOEREN MET EEN NATUURLIJKE UITSTRALING

De levensechte houtdessins zien er uitermate realistisch uit. Elke laminaatvloer vertelt een eigen verhaal. Zelfs de voegen zijn voorzien van minuscule barsten om zo extra authenticiteit toe te voegen.

KRAS- EN VLEKBESTENDIGE VLOEREN

Alle laminaatvloeren van Quick•Step zijn tot tien keer beter bestand tegen krassen dankzij de Scratch Guard-bovenlaag. Daarnaast zijn ze ook uitermate vlekkenbestendig, schoonmaken ging nog nooit zo makkelijk.

100% WATERBESTENDIG LAMINAAT

De innovatieve, waterafstotende 'HydroSeal' coating, zorgt ervoor dat de laminaatvloeren van Quick•Step de eerste echt waterbestendig laminaatvloeren ter wereld zijn.

WATERDICHT PVC

Quick•Step's Alpha PVC is voorzien van een geavanceerd waterdicht kliksysteem. In combinatie met de waterafstotende technologie zorgt dit voor een volledig waterdichte vloer.

ULTRASTERK

Dankzij de ultrasterke kern van Alpha PVC en de unieke toplaag met kras- en vlekkenbestendige technologie maken krassen en vlekken geen kans.

GESCHIKT VOOR ONREGELMATIGE OPPERVLAKKEN

De vaste kern van Alpha PVC biedt nog een ander voordeel: in de meeste gevallen hoeft je je ondervloer niet voor te bereiden voor de plaatsing. De vloer is zelfs op onregelmatige oppervlakken te plaatsen.

SAMPLE SERVICE

Met de unieke sample service van PPC kun je heel eenvoudig een gratis sample bestellen van de desgewenste vloer. Via onze webshop bestel je heel makkelijk een sample. Wij sturen de sample naar jou op, waarna de klant deze bij jou in de winkel weer ophaalt.

4-UURS GARANTIE

PPC biedt een unieke 4-uurs garantie op vloeren. Doet zich een probleem voor? Dan leveren wij binnen 4 uur vervangend materiaal op de werkvloer! Zo kan je snel weer door.



4

OOK DEALER WORDEN? NEEM CONTACT OP MET JE VERTEGENWOORDIGER!

Het Quick•Step assortiment is exclusief verkrijgbaar bij een geselecteerd aantal dealers.

Quick•Step wordt ondersteund met een aantrekkelijke display, mooie folder, een eigen Instagram account en een overzichtelijke website met dealervermelding.

BESTEL JE SAMPLES



SCAN DE QR-CODE



Quick•Step® / RIGP20289 Visgraat Zonsopgang beige naturel eik

4.6 HOLLANDSCHE VLOEREN

Hollandsche Vloeren® is meer dan een gewone vloer: met dit complete verkoopconcept bied je jouw klanten dé blikvanger in hun huis. Dit A-merk staat voor eerlijke, natuurlijke eiken vloeren. Hiermee verkoop je minimaal 30 jaar woonplezier van een vloer met een perfecte pasvorm.

MAAK KENNIS MET DE 7 HOLLANDSCHE VLOEREN® FAMILIES

Deze collectie Hollandsche Vloeren® bestaat uit 7 vloerfamilies: Familie De Jong, Janssen, Visser, De Vries, Bakker, Smit en Van Dijk. De 7 families bestaan uit 7 kleur(tint)en en zijn allemaal in meerdere patronen leverbaar zoals: plank, visgraat, reuze visgraat en Hongaarse punt. De Families-collectie telt 31 eiken vloeren waarbij de verschillende legpatronen als gezinsleden worden gepresenteerd.

VLOERVERWARMING

Met een thermische weerstand van 0,080 m² K/W zijn Hollandsche Vloeren® uitermate geschikt voor vloerverwarming. De vloeren hebben een constante kwaliteit en liggen allemaal bij PPC op voorraad. Dit betekent dat onze unieke 4 uursgarantie ook voor alle Hollandsche Vloeren® geldt! De vloeren zijn kant-en-klaar en behoeven na het plaatsen geen nabewerking. Dankzij de twee lagen met UV-licht uitgeharde hardwaxolie zijn Hollandsche Vloeren® goed bestendig tegen krassen en vlekken.

SAMPLE SERVICE

Met de unieke sample service van PPC kun je heel eenvoudig een gratis sample bestellen van de desgewenste vloer. Via onze webshop bestel je heel makkelijk een sample. Wij sturen de sample naar jou op, waarna de klant deze bij jou in de winkel weer ophaalt.

**OOK DEALER WORDEN?****NEEM CONTACT OP MET JE VERTEGENWOORDIGER!**













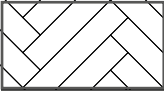
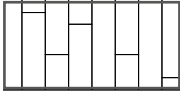
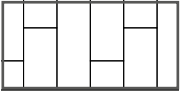





















Neem contact op met jouw vertegenwoordiger. Het Hollandsche Vloeren® assortiment is exclusief verkrijgbaar bij een geselecteerd aantal dealers. Hollandsche Vloeren® wordt ondersteund met een aantrekkelijke display, mooie folder, een eigen Instagram account en een overzichtelijke website met dealervermelding.

Via de unieke sampleservice worden consumenten naar de dealers verwezen om samples op te halen, zo zijn ze meteen op het juiste adres.





COMPLEET OVERZICHT

| |  |  |  |  |  |  |
|---|---|---|---|--|---|---|
| FAMILIES | AAFJE 600 X 120 X 13 MM | GUUSJE 1200 X 120 X 13 MM | HENDRIK 900 X 180 X 13 MM | MARIE 180 X 13 MM | GERRIT 220 X 13 MM | BERTUS 520 X 120 X 13 MM |
| DE JONG GESCHAAFD, HARDWAX |  |  |  |  |  | |
| VISSER GESCHAAFD, HARDWAX |  |  |  |  |  | |
| JANSSEN GESCHAAFD, DUBBEL GEROOKT, HARDWAX |  |  |  |  |  | |
| DE VRIES GESCHUURD, GEBORSTELD, HARDWAX |  |  | | |  |  |
| BAKKER GESCHUURD, GEBORSTELD, HARDWAX |  |  | | |  |  |
| SMIT GESCHUURD, GEBORSTELD, GEROOKT, HARDWAX |  |  | | |  |  |
| VAN DIJK GESCHUURD, GEBORSTELD, HARDWAX |  |  | | |  |  |

4

SAMPLE SERVICE

Met de unieke sample service van PPC kun je heel eenvoudig een gratis sample bestellen van de desgewenste vloer. Via onze webshop bestel je heel makkelijk een sample.

Wij sturen de sample naar jou op, waarna de klant deze bij jouw in de winkel weer ophaalt.







Bauwerk / Casapark 209, Oak Ambra 15

4.7 BAUWERK PARKETT

Niet voor niets is het Zwitserse Bauwerk al ruim 80 jaar dé producent van karakteristieke en hoogwaardige vloeren. Altijd innovatief op het gebied van gezond leven, duurzaamheid en design. De eiken houten vloeren bieden een constant hoge kwaliteit met een superieure passing. Vakmanschap is de basis voor het eersteklas kwaliteitsparket van Bauwerk.

SAMPLE SERVICE

Met de unieke sample service van PPC kun je heel eenvoudig een gratis sample bestellen van de desgewenste vloer. Via onze webshop bestel je heel makkelijk een sample. Wij sturen de sample naar jou op, waarna de klant deze bij jou in de winkel weer ophaalt.

4-UURS GARANTIE

PPC biedt een unieke 4-uurs garantie op vloeren. Doet zich een probleem voor? Dan leveren wij binnen 4 uur vervangend materiaal op de werkvloer! Zo kan je snel weer door.

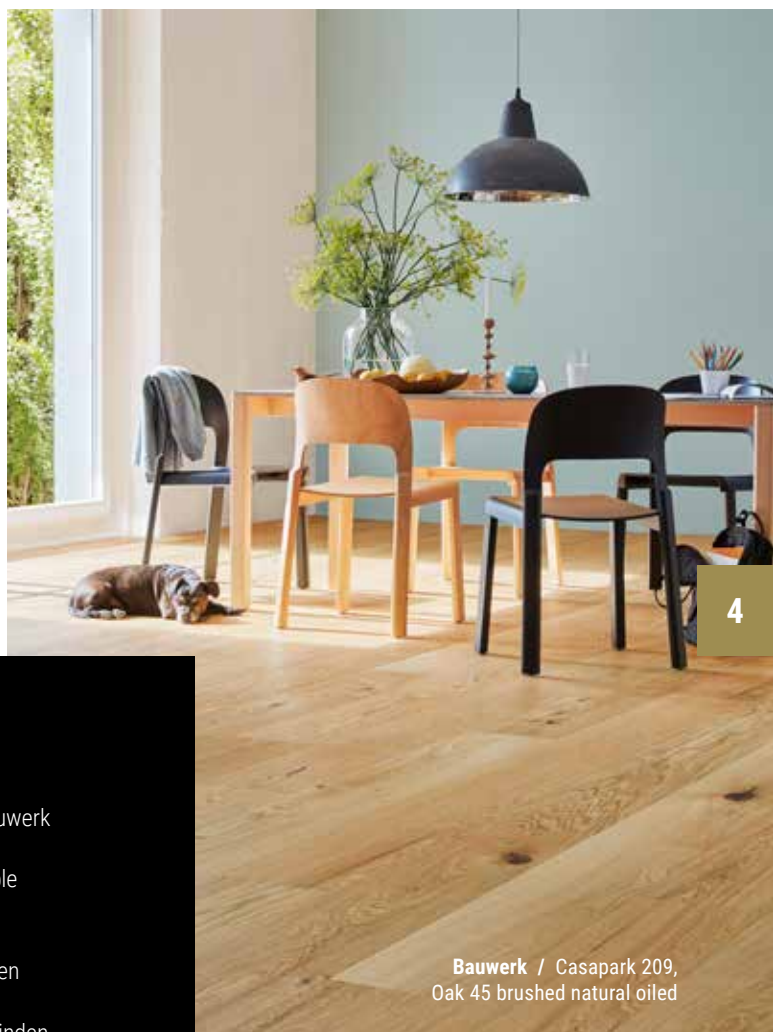

4

GESELECTEERDE DEALERNETWERK

Het complete assortiment is uitsluitend verkrijgbaar via het geselecteerde dealernetwerk, een klein deel is vrij verkrijgbaar. Als exclusieve dealer van Bauwerk profiteer je van mooie voordelen. Ondersteuning met fraai displaymateriaal, handwaaiers, architectenmappen en de mogelijkheid om van de unieke sample service gebruik te maken.

Daarnaast kan je als dealer gebruikmaken van de monsterbordenbibliotheek en een monsterboard in bruikleen nemen. Verder heeft Bauwerk een uitgebreide consumentenwebsite waarop de consument alles over de vloeren kan terugvinden. Interesse in een dealerschap van Bauwerk vloeren, neem contact op met je vertegenwoordiger.

Bauwerk / Casapark 209,
Oak 45 brushed natural oiled



Bauwerk / Casapark 209, Oak Sasso 15

ZWITSERS
 KWALITEITSPRODUCT 

4.8 WARM BY BAUWERK PARKETT

WARM biedt een unieke compacte houten vloercollectie in trendy kleuren die uitermate geschikt is voor gebruik bij vloerverwarming en vloerkoeling. De parketvloeren uit de WARM collectie hebben een eikenhouten toplaag met een levendig karakter door de rustieke sortering. Er is keuze tussen een slanke plankenvloer met 2-zijdige vellingkant of een chique visgraatpatroon, verkrijgbaar in vier verschillende eigentijdse kleuren. Zowel de visgraatvloeren als de planken zijn 2-laags parketvloeren die vast verlijmd worden op de dekvloer voor optimaal wooncomfort. De vloeren zijn slechts 9,5 mm dik en hebben een 2,5 mm eiken toplaag. Alle vloeren zijn kant-en-klaar afgewerkt.

HOOG RENDEMENT

Alle vloeren uit de WARM collectie hebben een extreem lage thermische weerstand: 0,049 m² K/W. Dit is de helft van vaak gestelde maximale waarde van 0,10. De vloeren zijn hierdoor perfect geschikt voor vloerverwarming! De lage warmteweerstand wordt gerealiseerd door de unieke productopbouw van deze parketvloeren: een HDF-onderlaag met daarop een eiken toplaag met een totale dikte van 9,5 mm. De onderlaag is zeer geleidend, waardoor de warmte van de vloerverwarming goed wordt doorgegeven.

ULTRA MATTE AFWERKING

Met parket beleef je decennialang woongenot, je kiest voor duurzame kwaliteit en zekerheid. Alle vloeren van de WARM collectie zijn kant-en-klaar afgewerkt. Drie vloeren zijn afgewerkt met een unieke ultramatte lak. Hierdoor zijn deze vloeren onderhoudsarm. De lakkleuren zijn: onbehandelde look, wit en een licht gerookte look. De collectie bevat ook een mooie, warme naturel geoliede vloer; een van de meest populaire afwerkingen van parket.

UNIEKE 4-UURS GARANTIE

PPC biedt een unieke 4-uurs garantie op vloeren. Doet zich een probleem voor? Dan leveren wij binnen 4 uur vervangend materiaal op de werkvloer! Zo kan je snel weer door.

**OOK DEALER WORDEN?**

WARM wordt ondersteund door fraai displaymateriaal, handwaaiers, een folder, een inspirerende consumentenwebsite en social media accounts. Via de unieke sampleservice worden consumenten naar de dealers verwezen om samples op te halen, zo zijn ze meteen op het juiste adres. Daarnaast kan je als dealer gebruikmaken van de monsterbordenbibliotheek en een monsterboard in bruikleen nemen. Handig om aan je klant mee te geven, dan blijft de display intact. Dit monsterbord kan na gebruik retour, waarna een creditnota voor het hele bedrag volgt.

Interesse in een dealerschap van WARM?
 Neem dan contact op met je vertegenwoordiger.



4.8 WARM BY BAUWERK (vervolg)

4.8.1 VISGRAAT

Visgraat en band voor visgraat

| | | | | | |
|---|---|---|--|--|----------------------------|
|  |  |  |  | Promotiemateriaal  Handwaaier Warm Visgraat | ArtikelNr. 04024 |
| Visgraat Caramel Macchiato, naturel geolied 04012 | Visgraat Cappuccino, invisible gelakt 04016 | Visgraat Latte Macchiato wit, invisible gelakt 04017 | Visgraat Caffé Mocha gebeitst, invisible gelakt 04018 | | |

| | Legsysteem | Vellingkant | Lengte | Breedte | Dikte | Verpakking | RC waarde |
|----------|--------------|-------------|--------|---------|--------|---------------------|--------------------------|
| Visgraat | Mes en groef | Geen | 47 cm | 7 cm | 9,6 mm | 2,11 m ² | 0,049 m ² K/W |

| | | | |
|---|---|---|--|
|  |  |  |  |
| Band Caramel Macchiato, naturel geolied 04033 | Band Cappuccino, invisible gelakt 04035 | Band Latte Macchiato, wit invisible gelakt 04032 | Band Caffé Mocha gebeitst, invisible gelakt 04030 |

| | Legsysteem | Vellingkant | Lengte | Breedte | Dikte | Verpakking | RC waarde |
|------|--------------|-------------|--------|---------|--------|---------------------|--------------------------|
| Band | Mes en groef | Geen | 125 cm | 10 cm | 9,6 mm | 2,00 m ² | 0,049 m ² K/W |

4.8.2 PLANKEN

Planken

| | | | | | |
|---|---|---|--|---|----------------------------|
|  |  |  |  | Promotiemateriaal  Handwaaier Warm Planken | ArtikelNr. 04023 |
| Caramel Macchiato geborsteld, naturel geolied 04716 | Cappuccino geborsteld, invisible gelakt 04717 | Latte Macchiato geborsteld, wit invisible gelakt 04718 | Caffé Mocha geborsteld, gebeitst, invisible gelakt 04719 | | |

| | Legsysteem | Vellingkant | Lengte | Breedte | Dikte | Verpakking | RC waarde |
|---------|--------------|-------------|--------|---------|--------|--------------------|--------------------------|
| Planken | Mes en groef | 2V | 170 cm | 15 cm | 9,6 mm | 2,3 m ² | 0,049 m ² K/W |

Trapneusprofiel 2-laags

PERFECT AANSLUITENDE TRAPAFWERKING

Met de WARM trapafwerking zijn bestaande trappen prachtig te moderniseren. De trapneusprofielen worden geproduceerd uit hetzelfde materiaal als de visgraatvloeren wat zorgt voor een naadloze afwerking. Door het gebruik van de zogenaamde origami-techniek worden krimpnaaden op de neus voorkomen.

| | | | | |
|---|---|---|--|---|
|  |  |  |  |  |
| Lengte 1.400 mm Dikte 9,5 mm Diepte 88 mm uitwendige maat 88x52 mm | Caramel Macchiato naturel geolied 04530 | Cappuccino, invisible gelakt 04532 | Latte Macchiato wit, invisible gelakt 04533 | Caffé Mocha gebeitst, invisible gelakt 04534 |

4



BOEN / Oak Andante white Castle plank, Live Pure

4.9 BOEN

Parketvloeren van BOEN, hét kwaliteitsparket met een superieure clickverbinding. Als een van de oudste vloerenmerken op de Europese markt is BOEN voor velen een oude bekende. Al decennialang staat het merk garant voor karakteristieke vloeren met een levendige en afwisselende look. De planken zijn voorzien van een innovatief kliksysteem, waardoor het leggen van de vloer snel en precies gaat. De parketvloeren van BOEN kunnen zowel zwevend als verlijmd gelegd worden en zijn geschikt voor vloerverwarming.

BOEN EIKEN ROCK PARKETVLOEREN

Met de prijsvriendelijke instapcollectie BOEN Eiken Rock wordt karakteristiek eiken voor een breed publiek beschikbaar. Deze prachtige rustieke eiken parketvloeren hebben een levendige, afwisselende look en een dikte van 13 mm. De instapcollectie bestaat uit acht vloeren. Alle vloeren zijn voorzien van tweezijdige vellingkanten. Vijf vloeren zijn afgewerkt met olie in commerciële kleuren. Drie vloeren zijn afgewerkt met een ultra matte lak voor nog meer onderhoudsgemak en helemaal passend bij de consument van nu. Een echte aanwinst voor de collectie dus!

BOEN ESPRESSIVO

BOEN heeft het afgelopen jaar zeker niet stilgezeten en de collectie uitgebreid met vijf nieuwe Espresso-vloeren, waarvan twee voor de Rock collectie. Dit zijn prachtige, rustieke vloeren met een extra levendig karakter door toevoeging van gestopte (kop)scheuren. Alle 5 Espresso-vloeren zijn uit voorraad leverbaar.

BOEN 3-STROOKS PARKETVLOEREN

Bovendien bevat de BOEN-collectie een uitgebreid aanbod aan parketvloeren met de unieke ultramatte Live Pure lakafwerking. Deze afwerking geeft de vloer de look en feel van een geoliede vloer, maar tegelijkertijd de bescherming van een gelakte vloer. De vloeren met de Live Pure afwerking zijn zeer onderhoudsvriendelijk.

4-UURS GARANTIE

PPC biedt een unieke 4-uurs garantie op vloeren. Doet zich een probleem voor? Dan leveren wij binnen 4 uur vervangend materiaal op de werkvloer! Zo kan je snel weer door.

| Handwaaiers | Artikelnr. |
|---|--|
|  | Handwaaiër 1 BOEN 3-strooks Eiken naturel/wit 01993 |
|  | Handwaaiër 2 BOEN 3-strooks Eiken kleurlie 01995 |
|  | Handwaaiër 3 BOEN 3-strooks Overige houtsoorten 01996 |



4

HET COMPLETE BOEN ASSORTIMENT AANBIEDEN?













Het Boen assortiment is exclusief verkrijgbaar bij een geselecteerd aantal dealers. Word BOEN-dealer en maak gebruik van de mooie display, brochures, social media en naamsvermelding op de BOEN-website. Daarnaast heeft de dealer de mogelijkheid om van de unieke sample service gebruik te maken en zo de consument met de sample te overtuigen.

Tevens kan je als BOEN-dealer gebruikmaken van de monsterbordenbibliotheek en een monsterboard in bruikleen nemen. Handig om aan je klant mee te geven, dan blijft de display intact. Dit monsterbord kan na gebruik retour, waarna een creditnota voor het hele bedrag volgt. Bespreek de mogelijkheden met je vertegenwoordiger.



BOEN / Oak Authentic Castle plank

3-strooks

| | | | | | |
|---|--|--|--|--|--|
|  Essen andante Live Natural 01002 |  Canadees esdoorn andante Live Natural 01013 |  Beuk andante Live Natural 01017 |  Eik andante wit Live Natural 01036 |  Eik coral finale Live Natural 01042 |  Eik pearl finale Live Natural 01044 |
|  Eik sand finale Live Natural 01045 |  Eik andante Live Natural 01024 |  Beuk andante Live Matt 01016 |  Eik andante Live Matt 01023 | | |
|  Eik finale geborsteld Live Pure 01031 |  Eik andante geborsteld Live Pure 01026 |  Eik concerto wit geborsteld Live Pure 01040 | | | |

| Legsysteem | Vellingkant | Lengte | Breedte | Dikte | Verpakking | RC waarde | Garantie |
|------------------|-------------|--------|---------|-------|---------------------|--------------------------|----------|
| X-Press Click 5G | Geen | 220 cm | 21,5 cm | 14 mm | 2,84 m ² | 0,093 m ² K/W | 25 jaar |

Eiken Rock

| | | | | | |
|--|---|---|---|--|--|
|  Natuurlijk geolied⁽¹⁾ 02009 |  Geborsteld wit⁽¹⁾ geolied 02010 |  Sand grijs geolied⁽¹⁾ 02015 |  Wit geolied⁽¹⁾ 02017 |  Vivo geborsteld⁽²⁾ Live Pure 01288 |  Pale white geborsteld⁽²⁾ Live Pure 01289 |
|--|---|---|---|--|--|

Eiken Espresso

| | |
|---|---|
|  Eiken espresso geborsteld⁽¹⁾ Live Pure 01470 |  Eiken espresso geborsteld⁽¹⁾ Live Natural 01467 |
|---|---|

| Legsysteem | Vellingkant | Lengte | Breedte | Dikte | Verpakking | RC waarde | Garantie |
|----------------------|-------------|--------|---------|-------|---------------------|--------------------------|----------|
| (1) X-Press Click 5G | 2V | 220 cm | 18,1 cm | 13 mm | 3,19 m ² | 0,09 m ² K/W | 25 jaar |
| (2) X-Press Click 5G | 2V | 180 cm | 18,1 cm | 14 mm | 2,61 m ² | 0,093 m ² K/W | 25 jaar |









BOEN / Oak Animoso, mix van de 3 breedtes

4.10 EUROPEES EIKEN DUOPLANK

EUROPEES EIKEN DUOPLANK

Verkrijgbaar in planken en visgraatpatroon, behandeld en onbehandeld. De duoplanken hebben een 4 mm dikke toplaag van Europees eiken op een drager van 9 mm dik berken-multiplex met mes-en-groef. Dit geeft een perfecte passing en maatvastheid. Zowel met als zonder vellingkant beschikbaar. De toplaag is voorgeschuurd met korrel 100 dan wel 120; na-schuren is niet nodig. Om de collectie en mogelijkheden eenvoudig aan de klant te presenteren is er een merkloze duoplank handwaaier beschikbaar.

DUOPLANK - VIGRAAT - PLANCHETTES

| | | |
|--|---|---|
|  |  |  |
| Duoplank eiken rustiek AB | Duoplank eiken 1° sortering | Duoplank eiken rustiek AB |
| 03520 | 03510 | 03534 |
|  |  | |
| Visgraat 1° sortering | Visgraat 1° sortering vlak | |
| 03516 | 03529 | |
|  |  | |
| Planchettes europees eik rustiek | Planchettes europees eik rustiek | |
| 03401 | 03393 | |

| Artikelnr. | Soort | Sortering | Veiling | Afwerking | Lengte | Breedte | Dikte | Verpakking |
|------------|----------------|--------------|---------|-----------|------------|---------|-------|----------------------|
| 03520 | Duoplank eiken | Rustiek AB | 2V | Geschuurd | 195/240 cm | 22 cm | 13 mm | Per m ² |
| 03510 | Duoplank eiken | 1e sortering | 2V | Geschuurd | 195/240 cm | 22 cm | 13 mm | Per m ² |
| 03534 | Duoplank eiken | Rustiek AB | 2V | Geschuurd | 195/240 cm | 18 cm | 13 mm | Per m ² |
| 03516 | Visgraat | 1e sortering | 4V | Geschuurd | 60 cm | 12 cm | 13 mm | 0,864 m ² |
| 03529 | Visgraat | 1e sortering | Geen | Geschuurd | 60 cm | 12 cm | 13 mm | 0,864 m ² |
| 03401 | Planchettes | Rustiek | Geen | Onbewerkt | 30 cm | 6 cm | 10 mm | 2,16 m ² |
| 03393 | Planchettes | Rustiek | Geen | Onbewerkt | 36 cm | 6 cm | 10 mm | 2,16 m ² |



MET GROOT GEMAK BESTELD.



ACHTER DE SCHERMEN IS **NICK DRUK** AAN HET WERK

Dag in dag uit nemen we bij PPC de webshop onder de loep en voeren we innovaties en vernieuwingen door om het gebruiksgemak te vergroten. Nick van der Geer, webshopmedewerker bij PPC, is continue bezig om het online bestelproces zo optimaal mogelijk te maken. Of het nu gaat om complete productinformatie, locatielevering of handige zoektools. Voor onze klant moet het bijzonder makkelijk zijn om de juiste keuze te maken. Dit doen wij met zorgvuldig gekozen filters, slimme tools zoals de ondervloeren- en plintenzoeker, het delen van de actuele voorraadstatus van producten per filiaal, mogelijkheid tot snel bestellen, een soepele online retourservice en praktische demonstratiefilmpjes.



BREED EN INNOVATIEF ASSORTIMENT

RICHARD HEEFT DE VAART ERIN

Als Richard al onze voorradige vloeren neer zou leggen dan krijg je een oppervlakte van maar liefst 50 voetbalvelden. Met meer dan 250.000 vierkante meter aan vloeren heeft PPC met zijn unieke vorm van verkoop en distributie inmiddels één van de grootste assortimenten aan vloeren van Nederland. Kwaliteit staat altijd voorop bij PPC.

Als toonaangevende partner voor de vloerspecialist zijn we voortdurend bezig met het door ontwikkelen van ons assortiment door de wensen van de markt te vertalen naar unieke concepten en producten. Omdat wij voor het beste gaan, biedt PPC een unieke 4-uurs garantie op vloeren: mocht zich een probleem voordoen, dan leveren wij binnen vier uur vervangend materiaal op de werkvloer.



5. SCHUREN

| | | |
|------------|---------------------------------|-----------|
| 5.1 | SCHUURBANDEN EN SCHIJVEN | 90 |
| 5.1.1 | BONA | 90 |
| 5.1.2 | SIA | 91 |
| 5.1.3 | MIRKA | 92 |
| 5.1.4 | FESTOOL | 92 |
| 5.1.5 | PPC | 92 |
| 5.1.6 | MULTIHOLE | 92 |
| 5.1.7 | DR. SCHUTZ | 93 |
| 5.2 | OVERIG SCHUURMATERIAAL | 93 |
| 5.3 | GAASSCHIJVEN | 93 |
| 5.4 | PADS | 93 |
| 5.5 | VOEG- EN STOPMIDDELEN | 94 |
| 5.5.1 | PUTTY | 94 |
| 5.5.2 | VOEGENKIT | 94 |
| 5.5.3 | VOEGPASTA | 94 |
| 5.5.4 | GEREEDSCHAP | 94 |



5.1 SCHUURBANDEN EN SCHIJVEN

5.1.1 BONA

Schuurbanden 8700 keramisch

Artikelnr.

**200 x 750 mm**

Voor bandschuurmachines 200 mm, zoals Bona Belt en Hummel

| Per | Korrel | |
|-----|--------|-------|
| 5 | K36 | 95503 |
| 5 | K50 | 95504 |

**250 x 750 mm**

Voor bandschuurmachines 250 mm, zoals Bona Belt en Hummel

| Per | Korrel | |
|-----|--------|-------|
| 5 | K36 | 95505 |
| 5 | K50 | 95506 |

Schuurbanden 8600 keramisch groen

Artikelnr.

**200 x 750 mm**

Voor bandschuurmachines 200 mm, zoals Bona Belt en Hummel

| Per | Korrel | |
|-----|--------|-------|
| 10 | K36 | 95687 |
| 10 | K40 | 95702 |
| 10 | K50 | 95688 |
| 10 | K60 | 95388 |
| 10 | K80 | 95689 |
| 10 | K100 | 95690 |
| 10 | K120 | 95691 |

**250 x 750 mm**

Voor bandschuurmachines 250 mm, zoals Bona Belt en Hummel

| Per | Korrel | |
|-----|--------|-------|
| 10 | K36 | 95692 |
| 10 | K40 | 95703 |
| 10 | K50 | 95693 |
| 10 | K60 | 95699 |
| 10 | K80 | 95694 |
| 10 | K100 | 95695 |
| 10 | K120 | 95696 |

Schuurbanden 8300 blauw

Artikelnr.

**200 x 750 mm**(meest voorkomend)
Voor Bona Belt en Hummel

| Per | Korrel | |
|-----|--------|-------|
| 10 | K24 | 95401 |
| 10 | K36 | 95403 |
| 10 | K40 | 95404 |
| 10 | K60 | 95406 |
| 10 | K80 | 95407 |
| 10 | K100 | 95408 |
| 10 | K120 | 95409 |
| 10 | K150 | 95410 |

**250 x 750 mm**

Voor o.a. Flexi Drum en Profit

| Per | Korrel | |
|-----|--------|-------|
| 10 | K24 | 95391 |
| 10 | K36 | 95393 |
| 10 | K40 | 95394 |
| 10 | K60 | 95396 |
| 10 | K80 | 95397 |
| 10 | K100 | 95398 |
| 10 | K120 | 95399 |

**200 x 551 mm**

Voor bandschuurmachines

| Per | Korrel | |
|-----|--------|-------|
| 10 | K24 | 95412 |
| 10 | K36 | 95413 |
| 10 | K40 | 95414 |
| 10 | K60 | 95416 |
| 10 | K80 | 95417 |
| 10 | K100 | 95418 |
| 10 | K120 | 95419 |

Schuurschijven 8700 keramisch

Artikelnr.

**Ø 125 mm**

Voor satelliet

| Per | Korrel | |
|-----|--------|-------|
| 25 | K36 | 95510 |
| 25 | K50 | 95511 |

**Ø 150 mm**

Voor Bona Combi, Edge, Flexi Sand en Flip

| Per | Korrel | |
|-----|--------|-------|
| 25 | K36 | 95512 |
| 25 | K50 | 95513 |

**Ø 178 mm**

Voor kantenschuurmachine

| Per | Korrel | |
|-----|--------|-------|
| 25 | K36 | 95514 |
| 25 | K50 | 95515 |

Schuurschijven 8600 keramisch groen

Artikelnr.

**Ø 150 mm**

Voor Bona Mini-Edge, Powerdrive en Quattro Disc

| Per | Korrel | |
|-----|--------|-------|
| 25 | K36 | 95677 |
| 25 | K40 | 95700 |
| 25 | K50 | 95678 |
| 50 | K60 | 95697 |
| 50 | K80 | 95679 |
| 50 | K100 | 95680 |
| 50 | K120 | 95681 |

**Ø 178 mm**

Voor kantenschuurmachine

| Per | Korrel | |
|-----|--------|-------|
| 25 | K36 | 95682 |
| 25 | K40 | 95701 |
| 25 | K50 | 95683 |
| 25 | K60 | 95698 |
| 25 | K80 | 95684 |
| 25 | K100 | 95685 |
| 25 | K120 | 95686 |

Schuurschijven 8300 blauw

Artikelnr.

**Ø 125 mm**

Voor Satelliet

| Per | Korrel | |
|-----|--------|-------|
| 50 | K60 | 95483 |
| 50 | K80 | 95484 |
| 50 | K100 | 95485 |
| 50 | K120 | 95486 |

**Ø 150 x 8 mm Mini-Edge**

Voor Bona Combi Edge, Flexi Sand en Flip

| Per | Korrel | |
|-----|--------|-------|
| 25 | K24 | 95451 |
| 50 | K40 | 95452 |
| 50 | K60 | 95453 |
| 50 | K80 | 95454 |
| 50 | K100 | 95455 |
| 50 | K120 | 95456 |

**Ø 150 mm Rotex**

Voor o.a. Festool, Makita en Bona FlexiSand. Klittebandsysteem met 8 stofgaten

| Per | Korrel | |
|-----|--------|-------|
| 25 | K24 | 95670 |
| 25 | K36 | 95671 |
| 50 | K40 | 95672 |
| 50 | K60 | 95673 |
| 50 | K80 | 95674 |
| 50 | K100 | 95675 |
| 50 | K120 | 95676 |

Schuurschijven 8300 blauw

Artikelnr.

**Ø 178 x 22 mm**

Voor kantenschuurmachine, Bona Edge XL en Unico

| Per | Korrel | |
|-----|--------|-------|
| 25 | K24 | 95421 |
| 50 | K40 | 95422 |
| 50 | K60 | 95423 |
| 50 | K80 | 95424 |
| 50 | K100 | 95425 |
| 50 | K120 | 95426 |

Schuurschijven 8100 zwart

Artikelnr.

**Ø 115 mm Flex**

Voor flex schuurmachine

| Per | Korrel | |
|-----|--------|-------|
| 50 | K40 | 95470 |
| 50 | K80 | 95472 |
| 50 | K120 | 95474 |

**Ø 150 mm Rotex**

Voor o.a. Festool, Makita en Bona FlexiSand. Klittebandsysteem met 8 stofgaten

| Per | Korrel | |
|-----|--------|-------|
| 25 | K36 | 95430 |
| 50 | K40 | 95431 |
| 50 | K50 | 95432 |
| 50 | K80 | 95433 |
| 50 | K100 | 95434 |
| 50 | K120 | 95435 |

**Ø 150 mm Powerdrive schuurschijf**

Voor Mini-Edge

| Per | Korrel | |
|-----|--------|-------|
| 50 | K40 | 95490 |
| 50 | K60 | 95491 |
| 50 | K80 | 95492 |
| 50 | K100 | 95493 |
| 50 | K120 | 95494 |

**Ø 200 mm Trio**

| Per | Korrel | |
|-----|--------|-------|
| 50 | K60 | 95442 |
| 50 | K80 | 95443 |
| 50 | K100 | 95444 |
| 50 | K120 | 95445 |

Schuurdriehoek

Artikelnr.

**8100 Fein 86 x 86 mm**

| Per | Korrel | |
|-----|--------|-------|
| 50 | K40 | 95462 |
| 50 | K60 | 95463 |
| 50 | K80 | 95464 |
| 50 | K100 | 95465 |

**Wings**

| Per | Korrel | |
|-----|--------|-------|
| 50 | K120 | 95225 |
| 50 | K150 | 95226 |

5.1.1 BONA (vervolg)

| Diamond | | Artikelnr. |
|--|---------------|------------|
| Voor tussenschuren van UV-lakken en het opruwen van tegels | | |
| Ø 150 mm schuurschijf | | |
| Per | Korrel | |
| 1 | K80 | 95222 |
| 1 | K120 | 95223 |
| 1 | K240 | 95227 |
| Ø 150 mm flexibele tussenschijf | | 95228 |
| Per 1 stuk | | |

| Net gaasschijven | | Artikelnr. |
|-------------------------|---------------|------------|
| Ceramic Ø 150 mm | | |
| Per | Korrel | |
| 50 | K80 | 95216 |
| 50 | K100 | 95221 |
| 50 | K120 | 95224 |
| Alox Ø 150 mm | | |
| Per | Korrel | |
| 50 | K80 | 95217 |
| 50 | K100 | 95218 |
| 50 | K120 | 95219 |

5.1.2 SIA

| Schuurband Hummel Siawood 2920 | | Artikelnr. |
|---|---------------|------------|
| 200 x 750 mm | | |
| Voor bandschuurmachines 200 mm, zoals Bona Belt en Hummel | | |
| Per | Korrel | |
| 10 | K24 | 76876 |
| 10 | K40 | 76877 |
| 10 | K60 | 76878 |
| 10 | K80 | 76879 |
| 10 | K100 | 76880 |
| 10 | K120 | 76881 |
| 10 | K150 | 76882 |

| Schuurband Hummel Siaral 2812 | | Artikelnr. |
|---|---------------|------------|
| 200 x 750 mm | | |
| Voor bandschuurmachines 200 mm, zoals Bona Belt en Hummel | | |
| Per | Korrel | |
| 10 | K24 | 76801 |
| 10 | K36 | 76802 |
| 10 | K40 | 76803 |
| 10 | K60 | 76804 |
| 10 | K80 | 76805 |
| 10 | K100 | 76806 |
| 10 | K120 | 76807 |

| Schuurband Hummel Siabite 2515 | | Artikelnr. |
|---|---------------|------------|
| 200 x 750 mm | | |
| Voor bandschuurmachines 200 mm, zoals Bona Belt en Hummel | | |
| Per | Korrel | |
| 5 | K36 | 76800 |

| Schuurschijven Siawood 1919 | | Artikelnr. |
|---|---------------|------------|
| Ø 150 mm Rotex | | |
| Voor o.a. Festool, Makita en Bona FlexiSand | | |
| Per | Korrel | |
| 50 | K40 | 76863 |
| 50 | K60 | 76864 |
| 50 | K80 | 76865 |
| 50 | K100 | 76866 |
| 50 | K120 | 76867 |

| Schuurschijven Siawood 1919 | | Artikelnr. |
|-----------------------------|---------------|------------|
| Ø 178 mm | | |
| Voor kantenschuurmachine | | |
| Per | Korrel | |
| 50 | K40 | 76849 |
| 50 | K60 | 76850 |
| 50 | K80 | 76851 |
| 50 | K100 | 76852 |
| 50 | K120 | 76853 |

| Schuurschijven Siawood 1919 | | Artikelnr. |
|-----------------------------|---------------|------------|
| Ø 200 mm Trio | | |
| Per | Korrel | |
| 50 | K40 | 76831 |
| 50 | K60 | 76832 |
| 50 | K80 | 76833 |
| 50 | K100 | 76834 |
| 50 | K120 | 76835 |

| Schuurschijven Siatop 1815 | | Artikelnr. |
|---|---------------|------------|
| Ø 150 mm voor Rotex | | |
| Voor o.a. Festool, Makita en Bona FlexiSand | | |
| Per | Korrel | |
| 50 | K40 | 76818 |
| 50 | K60 | 76819 |
| 50 | K80 | 76820 |
| 50 | K100 | 76821 |
| 50 | K120 | 76822 |

| Schuurschijven Siatop 1815 | | Artikelnr. |
|----------------------------|---------------|------------|
| Ø 178 mm | | |
| Voor kantenschuurmachine | | |
| Per | Korrel | |
| 50 | K24 | 76810 |
| 50 | K40 | 76811 |
| 50 | K60 | 76812 |
| 50 | K80 | 76813 |
| 50 | K100 | 76814 |
| 50 | K120 | 76815 |

| Schuurschijven Siaral 1749 | | Artikelnr. |
|----------------------------|---------------|------------|
| Ø 150 mm Unico | | |
| Per | Korrel | |
| 50 | K40 | 76911 |
| 50 | K60 | 76912 |
| 50 | K80 | 76913 |
| 50 | K100 | 76914 |
| 50 | K120 | 76915 |

| Schuurschijven Siaral 1749 | | Artikelnr. |
|----------------------------|---------------|------------|
| Ø 407 mm/16 inch | | |
| Per | Korrel | |
| 1 | K40 | 76870 |
| 1 | K60 | 76871 |
| 1 | K80 | 76872 |
| 1 | K100 | 76873 |

| Schuurschijven Siapar 1707 | | Artikelnr. |
|----------------------------|---------------|------------|
| Ø 178 mm Unico | | |
| Per | Korrel | |
| 50 | K40 | 76856 |

| Schuurschijven Siaspeed 1950 | | Artikelnr. |
|------------------------------|---------------|------------|
| Ø 150 mm Rotex | | |
| Per | Korrel | |
| 50 | K40 | 76825 |
| 50 | K60 | 76826 |
| 100 | K80 | 76827 |
| 100 | K120 | 76828 |

| Schuurdriehoek Siaspeed 1950 | | Artikelnr. |
|------------------------------|---------------|------------|
| 100 x 147 mm | | |
| Per | Korrel | |
| 50 | K40 | 76897 |
| 50 | K60 | 76898 |
| 50 | K80 | 76899 |
| 50 | K100 | 76900 |
| 50 | K120 | 76901 |
| 50 | K150 | 76902 |
| 50 | K180 | 76903 |
| 50 | K220 | 76904 |
| 50 | K240 | 76905 |
| 50 | K280 | 76906 |
| 50 | K320 | 76907 |
| 50 | K400 | 76908 |

| Schuurdriehoek Siarexx 1960 | | Artikelnr. |
|-----------------------------|---------------|------------|
| 90 x 95 mm | | |
| Per | Korrel | |
| 50 | K60 | 76888 |
| 50 | K80 | 76889 |
| 50 | K120 | 76890 |
| 50 | K150 | 76891 |
| 50 | K180 | 76892 |
| 50 | K240 | 76893 |
| 50 | K320 | 76894 |

| Keramische gaasschijven Sia Net 7500 | | Artikelnr. |
|--------------------------------------|---------------|------------|
| Ø 150 mm | | |
| Per | Korrel | |
| 50 | K80 | 76838 |
| 50 | K100 | 76839 |
| 50 | K120 | 76840 |
| 50 | K180 | 76841 |
| Ø 203 mm | | |
| Per | Korrel | |
| 50 | K80 | 76844 |
| 50 | K120 | 76845 |
| 50 | K180 | 76846 |

| Tussenschijf | | Artikelnr. |
|---------------------|--|------------|
| Ø 200 mm | | |
| Voor de Lägler Trio | | |
| | | 76885 |

5.1.3 MIRKA

| Schuurschijf Abranet Ace | | Artikelnr. |
|--------------------------|--------|------------|
| Ø 150 mm | | |
| Per | Korrel | |
| 50 | K80 | 95755 |
| 50 | K100 | 95756 |
| 50 | K120 | 95757 |
| 50 | K150 | 95762 |
| Ø 178 mm | | |
| Per | Korrel | |
| 50 | K80 | 95765 |
| 50 | K100 | 95766 |
| 50 | K120 | 95767 |
| Ø 200 mm | | |
| Per | Korrel | |
| 50 | K80 | 95759 |
| 50 | K100 | 95760 |
| 50 | K120 | 95761 |

| Schuurschijf Rotex Abranet Ace HD | | Artikelnr. |
|-----------------------------------|--------|------------|
| Ø 150 mm | | |
| Per | Korrel | |
| 25 | K40 | 95773 |
| 25 | K60 | 95774 |
| 25 | K80 | 95775 |

| Bescherm-pad/steunschijf | | Artikelnr. |
|---|---|------------|
|  | Voor Ø 150 mm Rotex Per 5 stuks | 95752 |
|  | Voor Ø 150 mm Deros 67H Per 5 stuks | 95751 |
|  | Steunschijf Deros Ø 150 mm Per 1 stuk | 95753 |
|  | Voor Ø 178 mm Per 1 stuk | 95768 |
|  | Voor Ø 200 mm Per 3 stuks | 95758 |

5.1.4 FESTOOL

| Schuurschijf Granat | | Artikelnr. |
|-----------------------------|--------|------------|
| STF-D125/9 Ø 125 mm | | |
| Per | Korrel | |
| 50 | K40 | 87732 |
| 50 | K80 | 87734 |
| 100 | K120 | 87736 |
| STF D150/48 Ø 150 mm | | |
| Per | Korrel | |
| 50 | K40 | 87790 |
| 50 | K60 | 87791 |

| Schuurschijf Granat Net | | Artikelnr. |
|--------------------------|--------|------------|
| STF D125 Ø 125 mm | | |
| Per | Korrel | |
| 50 | K80 | 87738 |
| 50 | K100 | 87739 |
| 50 | K120 | 87740 |
| STF D150 Ø 150 mm | | |
| Per | Korrel | |
| 50 | K80 | 87745 |
| 50 | K100 | 87746 |
| 50 | K120 | 87747 |

| Bescherm-pad Granat Net | | Artikelnr. |
|---|----------------------------------|------------|
|  | Rotex D125 Per 2 stuks | 87737 |
|  | Rotex D150 Per 2 stuks | 87744 |

| Schuurschijf Rubín | | Artikelnr. |
|---------------------------------|--------|------------|
| STF-D90/6 RU Ø 90 mm | | |
| Per | Korrel | |
| 50 | K80 | 87724 |
| 50 | K100 | 87725 |
| 50 | K120 | 87726 |
| 50 | K180 | 87728 |
| STF-D125/90 RU Ø 125 mm | | |
| Per | Korrel | |
| 50 | K50 | 87753 |
| 50 | K80 | 87754 |
| 50 | K100 | 87755 |
| 50 | K120 | 87756 |
| STF D150/48 RU2 Ø 150 mm | | |
| Per | Korrel | |
| 50 | K60 | 87793 |
| 50 | K80 | 87794 |
| 50 | K120 | 87796 |

| Schuurband Rubín | | Artikelnr. |
|-------------------------|--------|------------|
| BS75/533 x 75 RU | | |
| Per | Korrel | |
| 10 | K60 | 87853 |
| 10 | K100 | 87855 |

| Schuurdriehoek Rubín | | Artikelnr. |
|----------------------|--------|------------|
| STF-V93/6 RU | | |
| Per | Korrel | |
| 50 | K60 | 87833 |
| 50 | K80 | 87834 |
| 50 | K100 | 87835 |
| 50 | K120 | 87836 |

| Schuurstrook Rubín | | Artikelnr. |
|------------------------|--------|------------|
| STF-80 x 133/14 | | |
| Per | Korrel | |
| 50 | K60 | 87823 |
| 50 | K80 | 87824 |
| 50 | K120 | 87826 |
| 50 | K180 | 87828 |

| Interface pad | | Artikelnr. |
|---|--|------------|
|  | IP-STF D150/MJ2-5/2 Per 1 stuk | 87743 |

5.1.5 PPC

| Schuurschijf klit | | Artikelnr. |
|-------------------------|--------|------------|
| Ø 406 mm/16 inch | | |
| Per | Korrel | |
| 1 | K24 | 95202 |
| 1 | K40 | 95204 |
| 1 | K120 | 95206 |

5.1.6 MULTIHOLE

| Schuurschijf | | Artikelnr. |
|-------------------------|--------|------------|
| Ø 150 mm | | |
| Per | Korrel | |
| 25 | K80 | 95153 |
| 25 | K100 | 95154 |
| 25 | K120 | 95155 |
| Ø 178 mm | | |
| Per | Korrel | |
| 25 | K100 | 95164 |
| Ø 200 mm | | |
| Per | Korrel | |
| 25 | K80 | 95173 |
| 25 | K100 | 95174 |
| 25 | K120 | 95175 |
| Ø 406 mm/16 inch | | |
| Per | Korrel | |
| 1 | K80 | 95189 |
| 1 | K100 | 95190 |
| 1 | K120 | 95191 |
| 1 | K150 | 95192 |
| 1 | K180 | 95193 |

5.1.6 MULTIHOLE (vervolg)

| Scradpad/Dustpad | Artikelnr. |
|--|------------|
|  Scradpad/Dustpad Voor 16 inch schijven Per 1 stuk | 95195 |

5.1.7 DR. SCHUTZ

| | Artikelnr. |
|--|------------|
|  Abranopp Extreme schuurpad 16 inch voor QST Livyn Per 1 stuk | 91469 |
|  PU Saneringspad Per 1 stuk | 91470 |
|  TIP! Schuurmachines en steunschijven zijn te vinden in hoofdstuk 9: Gereedschap of kijk in onze webshop. | |















5.2 OVERIG SCHUURMATERIAAL





| Schuurmateriaal | Artikelnr. |
|---|------------|
|  Handschuurblok Mirka (i.c.m. 150 mm schijven) | 95754 |
|  SLC Durasoft wings K220 Per 50 stuks | 96669 |
|  Staalwol fijn (00) rol a 200 gram | 95230 |
|  Polijskussen Per 2 stuks | 98276 |
| Multi Glipper | Artikelnr. |
|  Multi Glipper Per 1 stuk | 85230 |
|  Driehoeksbasis met vezeldoek Per 3 stuks | 85231 |
|  Driehoeksbasis met schuurlijnen Per 3 stuks | 85232 |





5.3 GAASSCHIJVEN



| Gaasschijven | Artikelnr. | |
|--|---------------|-------|
|  Ø 406 mm/16 inch | | |
| Per | Korrel | |
| 1 | K60 | 95208 |
| 1 | K80 | 95209 |
| 1 | K100 | 95210 |
| 1 | K120 | 95211 |
| 1 | K150 | 95212 |
| 1 | K180 | 95213 |
| 1 | K220 | 95214 |
|  Woolpad Ø 407 x 8 mm Per 1 stuk | 96797 | |

5.4 PADS

| Pads Ø 406 mm/16 inch | Artikelnr. |
|--|------------|
|  Dun 1 cm (per stuk) | |
|  Wit | 92221 |
|  Beige | 92222 |
|  Rood | 92224 |
|  Blauw | 92226 |
|  Groen | 92223 |
|  Paars | 92227 |
|  Zwart | 92225 |
|  Dik 2 cm (per stuk) | |
|  Wit | 92231 |
|  Beige | 92232 |
|  Rood | 92234 |
|  Blauw | 92236 |
|  Groen | 92233 |
|  Zwart | 92235 |

| Pads Ø 330 mm/13 inch | Artikelnr. |
|--|------------|
|  Dik 2 cm (per stuk) | |
|  Wit | 92241 |
|  Beige | 92242 |
|  Rood | 92244 |
|  Groen | 92243 |

| Kleine pads | Artikelnr. |
|---|------------|
|  Ø 130 mm (per 3 stuks) | |
|  Wit | 92120 |
|  Beige | 92124 |
|  Groen | 92125 |

| Schuurvlies STF | Artikelnr. |
|--|------------|
|  Ø 150 mm (per 10 stuks) | |
|  Wit | 87782 |
|  Groen | 87781 |

PADS GEBRUIK

| | |
|--|--|
|  | Wit Uitboenen |
|  | Beige Inboenen |
|  | Rood Licht schrobben, inboenen |
|  | Blauw Licht schurend, inboenen |
|  | Groen Nat schrobben |
|  | Paars Tussenschuren lak |
|  | Zwart Strippen |

| Hand pads | Artikelnr. | |
|---|---|-------|
|  | Klein 9 x 15 cm Per 10 stuks | |
|  | Wit | 97314 |
|  | Groen | 97313 |
|  | Zwart | 97312 |
|  | Groot 12 x 15 cm Per 10 stuks | |
|  | Wit | 97326 |
|  | Groen | 97325 |
|  | Zwart | 97324 |
|  | Padhouder met handgreep voor grote pads 12 x 25 cm | 97323 |
|  | Padhouder met handgreep voor kleine pads 9 x 15 cm | 97311 |
|  | Padhouder met steelaansluiting voor grote pads 12 x 25 cm | 97321 |

5.5 VOEG- EN STOPMIDDELEN

5.5.1 PUTTY

| Vloeibaar hout | | Artikelnr. |
|---|-------------------------------|------------|
|  | Rubinol Putty 100 gram | |
| | Beuken donker | 83502 |
| | Eiken/Eiken licht | 83506 |
| | Eiken donker | 83507 |
| | Essen/Ahorn | 83508 |
| | Berken/Grenen | 83509 |
| | Mahonie/Merbau | 83510 |
| | Beuken/Hevea | 83511 |
| | Gerookt eiken | 83512 |
| | Lichtgrijs | 83513 |
| | Zwart | 83514 |
| | Kersen | 83518 |
| | Wengé | 83519 |
| | Kambala/Iroko | 83520 |
| | Walnoot | 83521 |
| | Essen wit | 83522 |

VLOER BESCHADIGD?
Reparatiemiddelen zijn te vinden in hoofdstuk 8: Onderhoud onder het kopje 8.4 reparatie.



TIP!

5.5.3 VOEGPASTA

| Voegpasta | Artikelnr. |
|---|------------------------------------|
|  | Voor PVC vloeren 1 liter |
| | Wit 85646 |
| | Grijs 85647 |
| | Zwart 85649 |
| | Bruin 85648 |
| | Beige 85650 |

| Hout poeder | Artikelnr. |
|---|--|
|  | Blanchon Mastiek Voor alle soorten hout, multiplex en fineerhout 200 gram |
| | Rustiek eik 90149 |
| | Wit hout 90150 |
| | Helder eik 90148 |

5.5.4 GEREEDSCHAP

| Gereedschap | Artikelnr. |
|---|--|
|  | RVS Spaan 27 cm 92181 35 cm 92180 |
|  | Plamuurmes RVS 6 cm 92182 |

5.5.2 VOEGENKIT



| Voegenkit | Inhoud | Artikelnr. |
|---|---|-------------------------|
|  | Blanchon voegenkit | 1 l 90195 10 l 90196 |
|  | Bona Mix & Fill voegenkit | 1 l 96700 5 l 96701 |
|  | Bona Mix & Fill Plus voegenkit | 5 l 96703 |
|  | Lobadur WS EasyFillPro voegenkit | 1 l 77087 5 l 77088 |
|  | RigoStep Fill voegenkit | 4 l 98904 |
|  | SLC Eco Aqua-Pur Flex voegenkit | 2 l 96602 |



6. OLIE & LAK

| | | |
|------------|------------------------------|------------|
| 6.1 | OLIE PER MERK | 96 |
| 6.1.1 | BLANCHON | 96 |
| 6.1.2 | BONA | 96 |
| 6.1.3 | FLOORSERVICE | 97 |
| 6.1.4 | LOBA | 98 |
| 6.1.5 | ROYL | 98 |
| 6.1.6 | WOCA | 100 |
| 6.2 | LAK PER MERK | 101 |
| 6.2.1 | BLANCHON | 101 |
| 6.2.2 | BONA | 101 |
| 6.2.3 | DR. SCHUTZ | 102 |
| 6.2.4 | FLOORSERVICE | 102 |
| 6.2.5 | KERAKOLL | 102 |
| 6.2.6 | LOBA | 102 |
| 6.2.7 | SKYLT | 103 |
| 6.2.8 | STEP | 103 |
| 6.2.9 | EKODUR | 104 |
| 6.2.10 | WOCA | 104 |
| 6.3 | VOEGENKIT PER MERK | 105 |
| 6.3.1 | BLANCHON | 105 |
| 6.3.2 | BONA | 105 |
| 6.3.3 | KERAKOLL | 105 |
| 6.3.4 | LOBA | 105 |
| 6.3.5 | RIGOSTEP | 105 |
| 6.4 | PRODUCTEN VOOR BUITEN | 105 |
| 6.4.1 | BLANCHON | 105 |
| 6.4.2 | ROYL | 106 |
| 6.4.3 | WOCA | 106 |

6.1 OLIE PER MERK

6.1.1 BLANCHON

| Blanchon hardwaxolie | | Kleur | Inhoud | Artikelnr. |
|---|---|-------------------|--------|------------|
|  | Hardwaxolie 1 liter per 20 m ² | Helder eik | 1 l | 90109 |
| | | Naturel | 1 l | 90110 |
| | | Naturel ultra mat | 1 l | 90111 |
| | | Ruw hout | 1 l | 90112 |
| | | Wit | 1 l | 90113 |
|  | Solid'Oil hardwaxolie 1 liter per 35 m ² | Naturel | 1 l | 90171 |
| | | Naturel | 1 l | 90172 |
| | | Snow | 1 l | 90173 |

| Blanchon olie | | Kleur | Inhoud | Artikelnr. |
|---|---|---------------|--------|------------|
|  | Parketolie 1 liter per 20 m ² | Kleurloos | 1 l | 90158 |
| | | | 5 l | 90159 |
|  | Olie milieu 1 liter per 15 m ² | Ultra naturel | 1 l | 90184 |
| | | | 5 l | 90185 |
| | | Ruw hout | 1 l | 90155 |
| | | | 5 l | 90156 |

| Blanchon onderhoudsolie | | Kleur | Inhoud | Artikelnr. |
|---|---|--------|--------|------------|
|  | Universele onderhoudsolie 1 liter per 40 m ² | Mat | 1 l | 90186 |
| | | Satijn | 1 l | 90187 |

| Blanchon anti-uv | | Inhoud | Artikelnr. |
|---|---|--------|------------|
|  | Anti-uv concentraat Aqua 5 ml per 1 liter lak of olie | 100 ml | 90186 |
| | | | 90187 |

6.1.2 BONA

| Bona olie | | Tester 40 ml | 400 ml | 1,25 l | |
|---|---|---|--------|--------|-------|
|  | Craft Oil 2K 1 liter per 35 m ² | | | | |
| | Ash |  | 96193 | 96201 | 96790 |
| | Black Night |  | 96242 | 96235 | 96241 |
| | Clay |  | 96200 | 96202 | 96799 |
| | Dark Brown |  | 96243 | 96234 | 96240 |
| | Dark grey |  | 96245 | 96232 | 96238 |
| | Driftwood |  | 96250 | 96248 | 96249 |
| | Frost |  | 96191 | 96203 | 96788 |
| | Graphite |  | 96192 | 96204 | 96789 |
| | Grey night |  | 96244 | 96233 | 96239 |
| | Invisible |  | 96198 | 96205 | 96795 |
| | Light Grey |  | 96195 | 96206 | 96792 |
| | Misty |  | 96247 | 96231 | 96237 |
| | Neutral |  | 96190 | 96207 | 96787 |
| | Neutral Light |  | 96199 | 96208 | 96796 |
| Old Grey |  | 96196 | 96209 | 96793 | |
| Provincial |  | 96253 | 96251 | 96252 | |
| Sand |  | 96197 | 96210 | 96794 | |
| Snow |  | 96246 | 96230 | 96236 | |
| Umbra |  | 96194 | 96211 | 96791 | |
| Bona kleurenwaaier Craft Oil | | | 96786 | | |



| Bona Oil Care | | Kleur | Inhoud | Artikelnr. |
|---|--|---------|--------|------------|
|  | Oil Care 1 liter per 40 m ² per laag | Naturel | 1 l | 96172 |
| | | | 5 l | 96173 |
| | | Grijs | 1 l | 96184 |

| Bona Craft Oil | | Kleur | Inhoud | Artikelnr. |
|---|--|-------|--------|------------|
|  | Craft Oil 1K 1 liter per 20 m ² | Pure | 1 l | 96159 |
| | | | 2,5 l | 96160 |
| | | Frost | 1 l | 96154 |
| | | | 2,5 l | 96170 |

| Bona voorkeuren | | Kleur | Inhoud | Artikelnr. |
|---|--|----------|--------|------------|
|  | Nordic Tone 1 liter per 8-10 m ² | | 5 l | 96174 |
| | | | | |
|  | Rich Tone Grey 1 liter per 8-10 m ² | | 5 l | 96174 |
| | | | | |
|  | Mix Colour voor Nordic Tone en Rich Tone Grey 1 flesje per 5 liter | Mahogany | 25 ml | 96176 |
| | | White | 25 ml | 96177 |
| | | Walnut | 25 ml | 96178 |
| | | Grey | 25 ml | 96179 |
| | | Black | 25 ml | 96180 |

6.1.3 FLOORSERVICE

| Floorservice | Hardwas-olie Classic - 1 liter per 24-30 m ² | | | Hardwas-olie Pro - 1 liter per 30-40 m ² | | | |
|---|---|-----|-------|---|-------|-------|-------|
| | | 1 l | 2,5 l | 5 l | 1 l | 5 l | |
|  | 001 Naturio | | 97921 | 97922 | 97923 | 97821 | 97823 |
| | 007 Isanti | | 97973 | | | | |
| | 100 Arctic | | 97925 | | | 97825 | 97827 |
| | 101 Polar | | 97930 | | 97931 | 97831 | |
| | 102 Alaska | | 97932 | | | 97872 | |
| | 114 Dover | | 97924 | | | | |
| | 120 Narvik | | 97933 | | | 97833 | |
| | 501 Ypsos | | 97945 | | | 97845 | |
| | 507 Skagen | | | | | 97847 | |
| | 720 Gobi | | 97949 | | | | |
| | 754 Beola | | 97981 | | | 97781 | |
| | 755 Cinza | | 97983 | | | | |
| | 756 Lunarda | | 97985 | | | | |
| | 757 Bernina | | | | | 97787 | |
| | 758 Psara | | 97989 | | | | |
| | 759 Stirling | | 97951 | | | 97851 | |
| | 800 Nevada | | 97953 | | | | |
| | 801 Canyon | | 97955 | | | 97855 | |
| | 802 Etowah | | 97957 | | | 97857 | |
| | 810 Havana | | 97961 | | | 97861 | |
| | 811 Brasil | | 97963 | | | 97863 | |
| | 812 Aztec | | 97965 | | | 97865 | |
| | 816 Kapora | | 97967 | | | | |
| | 902 Balmoral | | 97969 | | | 97869 | |
| | 990 Bunyoro | | 97971 | | | 97871 | |

| Floorservice olie | Tester 125 ml | 1 l |
|---|--|-------------|
|  | Hardwas-olie 2K 1 liter per 24-30 m ² | |
| | 001 Naturio | 97754 97995 |
| | 071 Lanai | 97755 97768 |
| | 170 Janna | 97756 97769 |
| | 175 Denali | 97757 97770 |
| | 178 Ceram | 97997 97996 |
| | 179 Kamet | 97758 97771 |
| | 770 Pago | 97759 97772 |
| | 773 Pinta | 97760 97773 |
| | 776 Tanna | 97761 97774 |
| | 810 Sonora | 97752 97994 |
| | 811 Brasil | 97753 97993 |
| | 872 Savo | 97762 97775 |
| | 875 Rossing | 97763 97776 |
| | 972 Koro | 97764 97777 |
| | 975 Taupo | 97765 97778 |
| | 979 Sakar | 97766 97779 |
|  | Handwaaijer FLS Hardwas-olie 2K | 97767 |

| Floorservice olie | Kleur | Inhoud | Artikelnr. |
|---|--|--------|------------|
|  | Hardwas-olie FF 1 liter per 24-30 m ² | | |
| | Zijdemat | 1 l | 97790 |
| | | 5 l | 97791 |
| | Mat | 1 l | 97792 |
| | | 5 l | 97793 |
| | Ultramat | 1 l | 97794 |
| | | 5 l | 97795 |
| | Ultramat white 1% | 1 l | 97796 |
| | | 5 l | 97797 |

| Floorservice vergrijzingsproduct | Kleur | Inhoud | Artikelnr. |
|---|---|---------------|------------|
|  | Prime Old Grey 1 liter per 4-8 m ² | | |
| | Grey I | Tester 100 ml | 97810 |
| | | 5 l | 97811 |
| | Grey V | Tester 100 ml | 97812 |
| | | 5 l | 97813 |
| | Grey X | Tester 100 ml | 97814 |
| | | 5 l | 97815 |

6.1.4 LOBA

| Lobasol olie | Kleur | Inhoud | Artikelnr. |
|---|---------------|-------------|--------------|
|  | HS Akzent 100 | Transparant | 750 ml 77064 |
| | | | 3 l 77028 |

| Lobasol olie | Inhoud | Artikelnr. |
|--------------|--------|------------|
| | 750 gr | 2,5 kg |



HS 2K ImpactOil
1 kg per 25-35 m²

| Kleur | Inhoud | Artikelnr. |
|-------------|--------|-------------|
| Antique Oak | | 77112 |
| Black | | 77104 |
| Chalk | | 77113 |
| Clay | | 77114 |
| Grey | | 77115 |
| Kambala | | 77109 |
| Mahonie | | 77107 |
| Oyster | | 77116 |
| Papyrus | | 77103 |
| Pearl | | 77117 |
| Sand | | 77118 |
| Silver | | 77119 |
| Smoked Oak | | 77110 |
| Sucupira | | 77105 |
| Transparant | | 77100 77101 |
| Walnut | | 77106 |
| Wengé | | 77111 |
| White | | 77102 |



| Lobasol wax | Inhoud | Artikelnr. |
|---|---------------------------|-----------------------------------|
|  | HS Akzent 100 Wax (OH-38) | 750 ml 77036 |
| | | 1 liter per 50-100 m ² |

| Lobasol pretone | Kleur | Inhoud | Artikelnr. |
|---|---------|--------|----------------------------------|
|  | Pretone | White | 2,5 l 77063 |
| | | | 1 liter per 10-12 m ² |



Pretone (sample) White 20 ml 77065
1 liter per 10-12 m²

6.1.5 ROYL

| ROYL Oil | Kleur | Inhoud | Artikelnr. |
|---|-------------|-------------|------------|
|  | Oil 1K | Clear #4550 | 1 l 98457 |
| | | | 5 l 98458 |
|  | Oil-2K | Clear #4560 | 1 l 98462 |
| | | | 5 l 98461 |
| | | Black #4562 | 1 l 98460 |
| | White #4561 | 1 l 98472 | |

| ROYL kleurpigment voor olie | Artikelnr. |
|-----------------------------|------------|
|-----------------------------|------------|



| | |
|-----------------------|-------|
| 01 voor 1 liter #0101 | 98477 |
| 02 voor 1 liter #0102 | 98478 |
| 03 voor 1 liter #0103 | 98479 |
| 08 voor 1 liter #0108 | 98480 |
| 09 voor 1 liter #0109 | 98481 |
| 10 voor 1 liter #0110 | 98482 |
| 11 voor 1 liter #0111 | 98483 |
| 12 voor 1 liter #0112 | 98484 |
| 13 voor 1 liter #0113 | 98485 |
| 14 voor 1 liter #0114 | 98486 |
| 15 voor 1 liter #0115 | 98487 |
| 16 voor 1 liter #0116 | 98488 |
| 17 voor 1 liter #0117 | 98489 |
| 18 voor 1 liter #0118 | 98490 |
| 19 voor 1 liter #0119 | 98491 |
| 20 voor 1 liter #0120 | 98492 |
| 21 voor 1 liter #0121 | 98493 |
| 22 voor 1 liter #0122 | 98494 |
| 23 voor 1 liter #0123 | 98495 |
| 25 voor 1 liter #0125 | 98496 |
| 26 voor 1 liter #0126 | 98497 |
| 27 voor 1 liter #0127 | 98498 |
| 28 voor 1 liter #0128 | 98499 |

TIP!

Toepasbaar in ROYL producten en SKYLT overlakbare kleurolie.

6.1.5 ROYL (vervolg)

| ROYL kleurmonster/tester | Artikelnr. |
|--|------------|
|  Alaska White C10 | 98501 |
| Antiquity C23 | 98502 |
| Antracite C25 | 98503 |
| Beachwood C17 | 98504 |
| Begone W01 | 98506 |
| Black Forest C20 | 98507 |
| Bliss C08+09 | 98508 |
| Colonial C18 | 98510 |
| Country Oak C03 | 98511 |
| Dark Oak C12 | 98512 |
| Double Alaska White C10+10 | 98513 |
| Double Smoked Oak C14 | 98514 |
| Driftwood C09+09 | 98515 |
| Exotic Brown C15 | 98516 |
| Foggy W09 | 98517 |
| Golden Oak C01 | 98518 |
| Grasping W17 | 98519 |
| Grumbling W20 | 98520 |
| Hound W14 | 98521 |
| Livid W10 | 98522 |
| Mahogany Red C21 | 98523 |
| Mountain Grey C09 | 98524 |
| Mystic Black C08 | 98525 |
| Natural Oak C11 | 98526 |
| North Sea C22 | 98527 |
| Ocean C28 | 98509 |
| Overcast W16 | 98528 |
| Pebble C16+16 | 98529 |
| Pitch B20 | 98530 |
| Rivet W23 | 98531 |
| Ruthless W19 | 98532 |
| Secret W12 | 98533 |
| Shell Grey C16 | 98534 |
| Smoked Oak C13 | 98535 |
| Sooty W22 | 98536 |
| Summer Beach W27 | 98537 |
| Summer Oak C02 | 98505 |
| Taupe W26 | 98445 |
| Walnut Dark C19 | 98446 |



Niet geschikt als eindproduct,
deze monsters zijn zuiver bedoeld als kleurtester!

| ROYL READY-MIXED kleuren | Inhoud | Artikelnr. |
|---|--|------------|
|  | Oil-2K READY-MIXED kleuren afgestemd op het verbruik van de meubelmaker (kleuren zie ROYL kleurmonsters) | |
| Alaska White C10 #4110 | 500 ml | 98459 |
| Double Alaska White C10+10 #4113 | 500 ml | 98463 |
| Foggy W09 #4118 | 500 ml | 98464 |
| Grasping W17 #4119 | 500 ml | 98465 |
| Livid W10 #4112 | 500 ml | 98466 |
| Mountain Grey C09 #4111 | 500 ml | 98467 |
| Natural Oak C11 #4115 | 500 ml | 98468 |
| Pitch B20 #4116 | 500 ml | 98469 |
| Shell Grey C16 #4114 | 500 ml | 98470 |
| Smoked Oak C13 #4117 | 500 ml | 98471 |

| ROYL Reactieve beits | Kleur | Inhoud | Artikelnr. | |
|---|--|--|--------------------------|----------------------------------|
|  | Reactieve beits 1 liter per 10-15 m ² Moet afgewerkt worden met ROYL olie. | Gebrand #4013 Gerookt #4014 Vergrijsd #4012 Wit #4011 | 1 l 1 l 1 l 1 l | 98473 98474 98475 98476 |

| ROYL waaier | Artikelnr. |
|---|-------------------------------|
|  | Houttintenwaaier 98797 |
|  | Grijsintenwaaier 98686 |

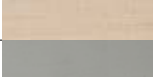
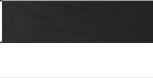
6.1.5 WOCA

WOCA houtloog Tester 100 ml 2,5 l**Houtloog**
1 liter per 10 m²**Wit**  97267 97205**Grijs**  97268 97206**Antiekloog**
(dubbel gerookt effect)  97269 97201**Drijfhoutloog**
1 liter per 8-10 m²**Wit**  97270 97202**Grijs**  97271 97203**Naaldhoutloog**
1 liter per 8-10 m² 97204WOCA pre-Colour 2,5 l**Pre-Colour**
1 liter per 8-10 m²**Wit**  97096**Grijs**  97097**Zwart**  97098WOCA Diamond Oil Active Tester 250 ml 1 l 2,5 l**Diamond Oil Active**
1 liter per 20-25 m²**Naturel**  97050 97051 97052**Wit**  97053 97054 97055**Extra wit**  97056 97057 97058**Sand grey**  97059 97060 97061**Concrete grey**  97062 97063 97064**Chocolate brown**  97065 97066 97067**Smoke brown**  97068 97069 97070**Caramel brown**  97071 97072 97073**Carbon black**  97074 97075 97076**Diamond Oil waaier** 97080WOCA olie Tester 25 ml 1 l 2,5 l 5 l**Master Colour Oil**
1 liter per 12-15 m²**Naturel** 97280 97101 97102 97103**Wit** 97281 97105 97106 97107WOCA Colour Oil Tester 25 ml 1 l 2,5 l**Master Colour Oil**
1 liter per 12-15 m²**101 Light brown**  97251 97152**102 Brazil brown**  97252 97153 97154**106 Rhode island brown**  97253 97159 97160**114 Castle grey**  97254 97161 97162**118 Extra wit**  97255 97165 97166**119 Walnut**  97256 97169 97170**120 Black**  97257 97167 97168**314 Extra grey**  97258 97171 97172**349 Antiek**  97262 97181 97182WOCA invisible Inhoud Artikelnr.**Invisible Oil Primer**
1 liter per 8-12 m² 1 l 97380
2,5 l 97377**Invisible Oil**
1 liter per 30-40 m² 1 l 97381
2,5 l 97378WOCA werkbladolie Kleur Inhoud Artikelnr.**Werkbladolie**
1 liter per 12-15 m² Naturel 750 ml 97431
Wit 750 ml 97434WOCA speciale producten Inhoud Artikelnr.**Olieverdunner** 1 l 97180**Gereedschappen**
zijn te vinden in hoofdstuk 9: Gereedschap
of kijk in onze webshop.

6.2 LAK PER MERK

6.2.1 BLANCHON

| Blanchon lak | Kleur | Inhoud | Artikelnr. |
|---|-----------|--------------------|------------|
|  | Iceberg | Ultra mat | 1 l 90121 |
| | | | 5 l 90122 |
|  | Initial | Mat | 5 l 90124 |
| | | | 10 l 90123 |
| | | Satijn | 5 l 90125 |
| | | | 10 l 90126 |
| | | Ultra mat | 1 l 90127 |
| | | | 5 l 90129 |
| 10 l 90128 | | | |
|  | Intensiv | Glanzend | 9 l 90131 |
| | | Mat | 9 l 90135 |
| | | Onzichtbaar effect | 9 l 90138 |
| | | Satijn | 9 l 90140 |
| | | Ultra mat | 9 l 90141 |
| | | Ultra naturel | 9 l 90144 |
|  | Performer | Mat | 5 l 90160 |
| | | Satijn | 5 l 90161 |

| Blanchon lak 2K | Kleur | Inhoud | Artikelnr. |
|---|-------------|--------------------|-------------------------------|
|  | Intensiv 2K | Glanzend | 1 l 90130 |
| | | Mat | 1 l 90132 |
| | | | 5 l 90134 |
| | | Onzichtbaar effect | 1 l 90136 |
| | | | 5 l 90137 |
| | | Satijn | 1 l 90139 |
| | | | 5 l 90133 |
| | | Ultra mat | 1 l 90145 |
| Ultra naturel | 1 l 90142 | | |
| 5 l 90143 | | | |
|  | Sport 2K | Mat | 9 l 90174 |
| | | | 1 liter per 10 m ² |

| Blanchon primer | Inhoud | Artikelnr. |
|---|-------------------------------|------------|
|  | Porienvuller geurarm | 10 l 90163 |
| | 1 liter per 10 m ² | |
|  | Porienvuller prelast | 1 l 90165 |
| | 1 liter per 10 m ² | 5 l 90164 |
|  | Prim'Sealer | 5 l 90168 |
| | 1 liter per 10 m ² | 10 l 90167 |

| Blanchon verharder | Inhoud | Artikelnr. |
|---|--------------------|--------------|
|  | Verharder Aqua Pro | 100 ml 90188 |
| | | 250 ml 90189 |
| | | 500 ml 90190 |
| | | 1 l 90191 |

6.2.2 BONA

| Bona grondlak | Kleur | Inhoud | Artikelnr. |
|---|----------------------|------------------|------------|
|  | Grondlak | Classic | 1 l 96713 |
| | | | 5 l 96710 |
| | | Intense | 5 l 96708 |
| | | (warme kleuring) | |
| | | Amber | 5 l 96705 |
| | (warme houtkleuring) | White ML | 5 l 96782 |
| | | Natural ML | 5 l 96784 |
| | | | |

| Bona Primer | Inhoud | Artikelnr. |
|---|---------------------------------|------------|
|  | Classic UX Primer | 5 l 96719 |
| | 1 liter per 8-10 m ² | |

| Bona Mega aflak | Kleur | Inhoud | Artikelnr. |
|---|------------|--------------------|------------|
|  | Mega aflak | Natural | 5 l 96737 |
| | | Extra mat | 5 l 96716 |
| | | Mat | 1 l 96714 |
| | | | 5 l 96711 |
| | | Halfmat/zijdeglans | 1 l 96746 |
| | | | 5 l 96747 |
| | | Hoogglans | 1 l 96707 |
| | | | 5 l 96709 |



| Bona Mega ONE aflak | Kleur | Inhoud | Artikelnr. |
|---|----------------|------------------|------------|
|  | Mega ONE aflak | Halfmat / Satiné | 1 l 96212 |
| | | | 5 l 96213 |
| | | Mat | 1 l 96214 |
| | | | 5 l 96215 |
| | | Extra Mat | 1 l 96216 |
| | | | 5 l 96217 |



| Bona Traffic HD aflak 2K | Kleur | Inhoud | Artikelnr. |
|---|---------------------|-----------|--------------|
|  | Traffic HD aflak 2K | Ultramat | 4,95 l 96695 |
| | | Extra Mat | 4,95 l 96722 |
| | | Mat | 4,95 l 96704 |
| | | Zijdemat | 4,95 l 96697 |
| | | Anti Slip | 4,95 l 96698 |
| Harder voor Traffic HD | | 450 ml | 96723 |

| Bona kleurenwaaier | Artikelnr. | |
|---|---------------|-------|
|  | Kleurenwaaier | 96785 |
| | Bona lakken | |

| Bona retarder | Inhoud | Artikelnr. |
|---|---------------------------|--------------|
|  | Retarder vertrager | 200 ml 96719 |
| | 0,2 liter per 5 liter lak | |

6.2.3 DR. SCHUTZ

| Dr. Schutz renovatiecoatings | | Kleur | Inhoud | Artikelnr. |
|---|---|---------------|--------|------------|
|  | 2K PU anticolor 1 liter per 22 m ² | Extra mat | 1,08 l | 91493 |
| | | | 6 l | 91476 |
| | | Mat | 1,08 l | 91494 |
| | | | 6 l | 91477 |
| | Satine | 2,5 l | 91478 | |
|  | 2K PU Protector 1 liter per 10 m ² | NEO extra mat | 5,5 l | 91487 |
| | | NEO mat | 5,5 l | 91488 |
|  | 2K PU Protector Ca. 50 ml per m ² | Ultramat | 5,5 l | 91489 |
| | | | 990 ml | 91490 |
| | | Extramat | 5,5 l | 91481 |
| | | Mat | 5,5 l | 91491 |
| | Satine/gloss | 5,5 l | 91492 | |



| Dr. Schutz renovatiecoatings | | Inhoud | Artikelnr. |
|---|--|--------|------------|
|  | 2K PU protector 100 Stumpfmat Ca. 50 ml per m ² | 5,5 l | 91496 |
|  | Antislip R10 voor PU 1:10 verhouding met de lak | 500 ml | 91537 |
|  | Antislip R11 voor PU 100 gram per 28,5 m ² | 440 gr | 91479 |

6.2.4 FLOORSERVICE

| Floorservice lak | | Inhoud | Artikelnr. |
|---|---|--------|------------|
|  | Nature Protect 2K 1 liter per 10 m ² | 1 l | 97892 |
| | | 5 l | 97893 |

| Floorservice grondlak | | Inhoud | Artikelnr. |
|---|---|--------|------------|
|  | Nature Sealer 60-120 gr per m ² per laag | 1 l | 97798 |
| | | 5 l | 97799 |

6.2.5 KERAKOLL



| Kerakoll grondlak | | Inhoud | Artikelnr. |
|---|--|--------|------------|
|  | SLC 1K Eco grondlak Aqua-Pur Basic rapid 1 liter per 8-10 m ² | 2,5 l | 96672 |
|  | SLC ECO 2K Grondlak Aqua-Pur Basic 1 liter per 10 m ² | 5,5 l | 96675 |

| Kerakoll lak | | Kleur | Inhoud | Artikelnr. |
|---|--|-----------|--------|------------|
|  | SLC ECO 2K Lak Aqua-Pur HPX 1 liter per 10-12 m ² | Satijn | 5 l | 96683 |
| | | Mat | 5 l | 96680 |
| | | Extra Mat | 5 l | 96682 |
| | | Natural | 5 l | 96636 |



6.2.6 LOBA

| Lobadur grondlak | | Inhoud | Artikelnr. |
|---|---|--------|------------|
|  | WS EasyPrime 1 liter per 10 m ² | 5 l | 77029 |
|  | HS 2K Intensive AT grondlak 1 liter per 8-10 m ² | 2,5 kg | 77004 |
|  | WS Sealer FR 1 liter per 8-10 m ² | 5 kg | 77089 |



| Lobadur lak | | Kleur | Inhoud | Artikelnr. |
|---|---|---------|--------|------------|
|  | WS EasyFinish 1 liter per 8-10 m ² | Mat | 1 l | 77018 |
| | | | 5 l | 77001 |
| | | Halfmat | 1 l | 77017 |
| | | | 5 l | 77003 |
| | | Glans | 5 l | 77002 |





| Lobadur 2K | | Kleur | Inhoud | Artikelnr. |
|---|--|-----------|--------|------------|
|  | WS 2K Duo 1 liter per 8-10 m ² | Extra mat | 5 l | 77005 |
| | | Mat | 1 l | 77006 |
| | | | 5 l | 77007 |
| | | Halfmat | 1 l | 77008 |
| | | | 5 l | 77009 |
|  | WS 2K Invisible Protect AT 1 liter per 8-10 m ² | Ultra mat | 1 kg | 77010 |
| | | | 5 kg | 77011 |

6.2.6 LOBA (vervolg)

| Lobadur 2K | Kleur | Inhoud | Artikelnr. |
|---|---------------------------------|---------|------------|
|  | 2K Supra A.T. | Halfmat | 5 kg 77015 |
| | 1 liter per 8-10 m ² | Mat | 5 kg 77016 |
| Lobadur Whitener | | Inhoud | Artikelnr. |
|  | Lobadur Whitener | 80 ml | 77067 |

6.2.7 SKYLT

| SKYLT | Inhoud | Artikelnr. |
|--|----------------------------------|------------|
|  | Grondlak #5020 | 1 l 98905 |
| | 1 liter per 8-10 m ² | 4 l 98909 |
|  | Sealer beton/cement #5030 | 1 l 98916 |
| | 1 liter per 8-10 m ² | 4 l 98917 |

| SKYLT overlakbare kleurolie | Inhoud | Artikelnr. |
|---|--|--------------|
|  | Overlakbare kleurolie 2K #5050 Clear | 1 l 98906 |
| | 1 liter per 30-50 m ² per laag | |
|  | Overlakbare kleurolie 2K #5051 White | 1 l 98907 |
| | 1 liter per 30-50 m ² per laag | |
|  | Overlakbare kleurolie 2K #5052 Black | 1 l 98938 |
| | 1 liter per 30-50 m ² per laag | |
|  | Verharder voor SKYLT overlakbare kleurolie 2K | 200 ml 98915 |
| | Overlakbare kleurolie wordt geleverd met een verharder. Je hoeft deze alleen te bestellen als de verharder kwijt is. | |

TIP!

SKYLT overlakbare kleurolie moet aangekleurd worden met ROYL kleurpigment, zie pagina 98

| SKYLT Original | Inhoud | Artikelnr. |
|---|---|--------------|
|  | Original 2KPU #5510 (Natural look) | 500 ml 98941 |
| | 1 liter per 8-10 m ² | 1 l 98942 |
| | | 4 l 98943 |
|  | SKYLT Original verharder voor 1 liter SKYLT Original verharder voor 4 liter | 98967 |
| | SKYLT Original wordt geleverd met een verharder. Je hoeft deze alleen te bestellen als de verharder kwijt is. | 98968 |
|  | STEP en SKYLT glans graden display | 98585 |

| SKYLT Titanium | Inhoud | Artikelnr. |
|--|---|------------|
|  | SKYLT Titanium 2K #5550 | 1 l 98930 |
| | 1 liter per 8-12 m ² | 4 l 98908 |
|  | SKYLT Titanium verharder voor 1 liter SKYLT Titanium verharder voor 4 liter | 98911 |
| | SKYLT Titanium wordt geleverd met een verharder. Je hoeft deze alleen te bestellen als de verharder kwijt is. | 98933 |

6.2.8 STEP

| STEP grondlak | Kleur | Inhoud | Artikelnr. | |
|---|---------------------------------|----------------------------------|------------|-------------|
|  | Parket grondlak | #6090 Naturel | 1 l 98590 | |
| | 1 liter per 8-10 m ² | | 4 l 98591 | |
| | | #6130 Warm | 1 l 98592 | |
| | | | 4 l 98593 | |
| RAINBOW grondlak kleur | | 125 ml | 1 l | 5 l |
|  | RAINBOW Color Primer | 1 liter per 10-12 m ² | | |
| | RAL 9010 | | 98699 | 98700 |
| | RM White | | 98690 | 98701 98702 |
| | RM Light Grey | | 98691 | 98703 98704 |
| | RM Dark Grey | | 98705 | 98706 |
| | RM Black | | 98707 | 98708 |

6.2.8 STEP (vervolg)

| STEP parketlak | Kleur | Inhoud | Artikelnr. |
|---|---|--|------------------------|
|  | Parketlak 1K 1 liter per 10-12 m ² | #6650 Mat | 1 l 98717 4 l 98718 |
| | | #6660 Satijn | 1 l 98719 4 l 98720 |
| | #6640 Ultramat | 1 l 98721 4 l 98722 | |
| | | Parketlak 2K 1 liter per 8-12 m ² | #6550 Mat |
| | #6560 Satijn | 1 l 98596 4 l 98597 | |
| #6540 Glans | 1 l 98598 4 l 98599 | | |
|  | Parketlak 2K verharder voor 1 liter | 98588 | |
| | Parketlak 2K verharder voor 4 liter | 98589 | |

| STEP kurklak | Kleur | Inhoud | Artikelnr. |
|---|--|-----------------------------|------------------------|
|  | Kurklak 1K 1 liter per 8-12 m ² | #6460 Satijn transparant | 1 l 98709 4 l 98710 |
| | | #6450 Mat transparant | 1 l 98711 4 l 98712 |
| | #6461 Satijn naturel | 1 l 98713 4 l 98714 | |
| | | #6451 Mat naturel | 1 l 98715 4 l 98716 |





| STEP overig | Inhoud | Artikelnr. |
|--|---------------------------------|------------|
|  Extender Voor 4 liter lak | 250 ml | 98920 |
|  Kambala primer | 1 l 98918 4 l 98921 | |
| | Seal ADD Voor 4 liter | 250 gr |
|  Wall satin transparant | 1 l | 98500 |

6.2.9 EKODUR

| EKODUR grondverf | Inhoud | Artikelnr. |
|---|---|------------|
|  | Grondverf #2030 Ca. 1 liter per 12 m ² | |
| | voor RAL 9001-9010-9016 | 1 l 98420 |
| | voor RAL 9005 | 1 l 98421 |

| EKODUR verf | Afwerking | Inhoud | Artikelnr. | |
|---|--|----------|------------|-----------|
|  | Schildersverf 1K Ca. 1 liter per 12 m ² | RAL 9001 | Mat | 1 l 98422 |
| | | | Satijn | 1 l 98426 |
| | RAL 9010 | Mat | 1 l 98423 | |
| | | Satijn | 1 l 98427 | |
| | RAL 9016 | Mat | 1 l 98424 | |
| | | Satijn | 1 l 98428 | |
| | RAL 9005 | Mat | 1 l 98425 | |
| | | Satijn | 1 l 98429 | |

6.2.10 WOCA



| WOCA lak | Kleur | Inhoud | Artikelnr. |
|--|--|--------------|------------|
|  | Base Primer 1 liter per 10-12 m ² | Naturel | 5 l 97141 |
| | | Nordic White | 5 l 97142 |
|  Master Optima lak 1 liter per 8-10 m ² | | 5 l | 97143 |
|  Master RD-2K lak 1 liter per 8-10 m ² | | 5 l | 97144 |
|  Master Invisible 2K lak 1 liter per 8-10 m ² | | 5 l | 97145 |
|  Floorpaint wit 1 liter per 6-10 m ² | | 2,5 l | 97615 |

6.3 VOEGENKIT PER MERK

6.3.1 BLANCHON

| Blanchon voegenkit | Inhoud | Artikelnr. |
|---|-------------------------------|------------|
|  | Voegenkit voor hout | 1 l 90195 |
| | 1 liter per 20 m ² | 10 l 90196 |

6.3.2 BONA

| Bona voegenkit | Inhoud | Artikelnr. |
|---|---|------------|
|  | Mix & Fill voegenkit | 1 l 96700 |
| | 1 liter per 10 m ² | 5 l 96701 |
|  | Mix & Fill Plus voegenkit | 5 l 96703 |
| | 1 liter per 10 m ² Voor eiken en lichtere houtsoorten | |

6.3.3 KERAKOLL

| Kerakoll voegenkit | Inhoud | Artikelnr. |
|---|--|------------|
|  | SLC Eco Aqua-Pur Flex voegenkit | 2 l 96602 |
| | 1 liter per 40 m ² | |

6.3.4 LOBA

| Loba voegenkit | Inhoud | Artikelnr. |
|---|---------------------------------|------------|
|  | WS EasyFillPro voegenkit | 1 l 77087 |
| | 1 liter per 20 m ² | 5 l 77088 |

6.3.5 RIGOSTEP

| RigoStep voegenkit | Inhoud | Artikelnr. |
|---|-------------------------------|------------|
|  | Fill voegenkit | 4 l 98904 |
| | 1 liter per 10 m ² | |

6.4 PRODUCTEN VOOR BUITEN

6.4.1 BLANCHON

| Blanchon hout saturator | Kleur | Inhoud | Artikelnr. |
|---|-------------------------------|---------------|--------------|
|  | Hout saturator | Exotisch hout | 750 ml 90115 |
| | 1 liter per 10 m ² | | 5 l 90116 |
| | | Licht hout | 750 ml 90117 |
| | | | 5 l 90118 |
| | | Natuur | 750 ml 90119 |
| | | | 5 l 90120 |

| Blanchon lazuurbeits | Kleur | Inhoud | Artikelnr. |
|---|----------------------------------|----------------|------------|
|  | Tech-Wood lazuurbeits | Donker | 1 l 90175 |
| | 1 liter per 10-14 m ² | Helder | 1 l 90176 |
| | | Kleurloos | 1 l 90177 |
| | | Mahonie bruin | 1 l 90178 |
| | | Midden eik | 1 l 90179 |
| | | Rustiek eik | 1 l 90180 |
| | | Vergrijsd hout | 1 l 90181 |
| | | Verguld eik | 1 l 90182 |

| Blanchon lang houdende lazuurbeits milieu | Kleur | Inhoud | Artikelnr. |
|---|---|--------|------------|
|  | Lang houdende lazuurbeits milieu | Zwart | 1 l 90147 |
| | 1 liter per 12 m ² | | |

| Blanchon vernis | Kleur | Inhoud | Artikelnr. |
|--|-------------------------------|-------------|------------|
|  | Vernis EXP | Glanzend | 1 l 90192 |
| | 1 liter per 12 m ² | Mat | 1 l 90193 |
| | | Onzichtbaar | 1 l 90194 |
| | | ruw hout | |

| Blanchon anti-uv | Inhoud | Artikelnr. |
|---|---|------------|
|  | Anti-uv conditioner | 1 l 90101 |
| | 1 liter per 12 m ² | |
|  | Anti-uv protector voor wandbekleding | 1 l 90102 |
| | 1 liter per 12 m ² | |

| Blanchon olie gevel- en wandbekleding | Kleur | Inhoud | Artikelnr. |
|---|--|-----------|------------|
|  | Dekkende olie voor gevelbekleding | Antraciet | 1 l 90105 |
| | 1 liter per 10 m ² | Grijs | 1 l 90106 |
|  | Olie voor wandbekleding | Ruw den | 1 l 90157 |
| | 1 liter per 10 m ² | | |

| Blanchon houtontgrijzer | Inhoud | Artikelnr. |
|---|------------------------------|------------|
|  | Hout ontgrijzer | 1 l 90114 |
| | 1 liter per 5 m ² | |

6.4.1 BLANCHON (vervolg)

| Blanchon afbijtmiddel | Inhoud | Artikelnr. |
|---|--|------------|
|  | Gebouw afbijtmiddel | 1 l 90107 |
| | 10' in gelvorm 1 liter per 4-5 m ² | 5 l 90108 |

6.4.2 ROYL

| ROYL buiten olie | Kleur | Inhoud | Artikelnr. |
|---|---|-----------|------------|
|  | Olie Extérieur | 1 l 98848 | |
| | #4570 Clear 1 liter per 15-30 m ² | | |

| WOCA primer | Inhoud | Artikelnr. |
|---|---------------------------------|-------------|
|  | Exterior Primer op waterbasis | 2,5 l 97454 |
| | 1 liter per 8-10 m ² | |

| WOCA hout ontgrijzer | Inhoud | Artikelnr. |
|---|---------------------------------|-------------|
|  | Hout ontgrijzer | 2,5 l 97429 |
| | 1 liter per 8-10 m ² | 5 l 97430 |

TIP!

Gereedschappen
zijn te vinden in hoofdstuk 9: Gereedschap
of kijk in onze webshop.

6.4.3 WOCA

| WOCA buitenproducten | Tester | 750 ml | 2,5 l |
|--|--------------|-------------|---------------------------------|
|  | Exterior Oil | | 1 liter per 8-10 m ² |
| | Antraciet | | 97413 97414 |
| | Bangkirai | | 97422 97424 |
| | Grijs | | 97409 97410 |
| | Hazelnoot | | 97449 97450 |
| | Lariks | | 97415 97416 |
| | Merbau | | 97447 97448 |
| | Naturel | | 97401 97423 |
| | Roodbruin | | 97417 |
| | Stone Grey | | 97443 97444 |
| | Teak | | 97403 97404 |
| | Thunder Grey | | 97445 97446 |
| | Walnoot | | 97411 97412 |
| | Wit | 97192 | 97405 97406 |
| | Zilver | | 97418 |
| | Zoutgroen | | 97419 |
| Zwart | 97183 | 97407 97408 | |

| WOCA Exterior | Inhoud | Artikelnr. |
|---|---------------------------------|-------------|
|  | Exterior cleaner | 1 l 97453 |
| | 1 liter per 6-10 m ² | 2,5 l 97426 |

7. RANDAFWERKING

| | | |
|-------------|---|------------|
| 7.1 | WITTE, ZWARTE EN GRIJZE PLINTEN | 108 |
| 7.1.1 | SFEERPLINTEN, MDF, KUNSTSTOF EN FLEXIBEL | 108 |
| 7.1.2 | BIJ-TIP-LAK | 110 |
| 7.1.3 | HOEK/EINDSTUK VOOR MDF PLINT | 110 |
| 7.1.4 | NEUTEN EN ARCHITRAVEN | 112 |
| 7.1.5 | MDF WIT GEGRONDE PLINTEN | 112 |
| 7.1.6 | WIT GEFOLIEDE PLINTEN | 112 |
| 7.1.7 | ZWART GEFOLIEDE PLINTEN | 112 |
| 7.1.8 | MERANTI HARDHOUT PLINTEN EN KOPLATTEN | 113 |
| 7.2 | DÖLLKEN PLINTEN | 113 |
| 7.3 | ALUMINIUM PLINTEN | 114 |
| 7.4 | FOLIE PLINTEN EN PROFIELEN | 116 |
| 7.5 | MASSIEF | 121 |
| 7.5.1 | PLINTEN, AFWERKLIJSTEN EN ROZETTEN | 121 |
| 7.5.2 | BAMBOE PLINTEN EN AFWERKLIJSTEN | 123 |
| 7.5.3 | STOFDORPELS | 123 |
| 7.6 | FINEER PLINTEN EN AFWERKLIJSTEN | 123 |
| 7.7 | PROFIELEN | 124 |
| 7.7.1 | DILATATIEPROFIELEN | 124 |
| 7.7.2 | OVERGANGSPROFIELEN | 124 |
| 7.7.3 | HOEKLIJN-, EIND- EN U-PROFIELEN | 126 |
| 7.7.4 | TRAPNEUSPROFIELEN | 128 |
| 7.7.5 | PROFIELEN VOOR PVC/LINOLEUM | 130 |
| 7.7.6 | KÜBERIT PROFIELEN | 131 |
| 7.7.7 | BUIGBARE PROFIELEN | 133 |
| 7.8 | CONVECTORPUT ROLROOSTERS | 134 |
| 7.9 | PVC BIEZEN | 135 |
| 7.10 | LUIKPROFIELEN EN -RINGEN | 135 |
| 7.11 | DEURSTOPPERS | 135 |
| 7.12 | HANDWAAIERS, FOLDERS EN DISPLAYS | 135 |

7.1 WITTE, ZWARTE EN GRIJZE PLINTEN

7.1.1 SFEEPLINTEN, MDF, KUNSTSTOF EN FLEXIBEL

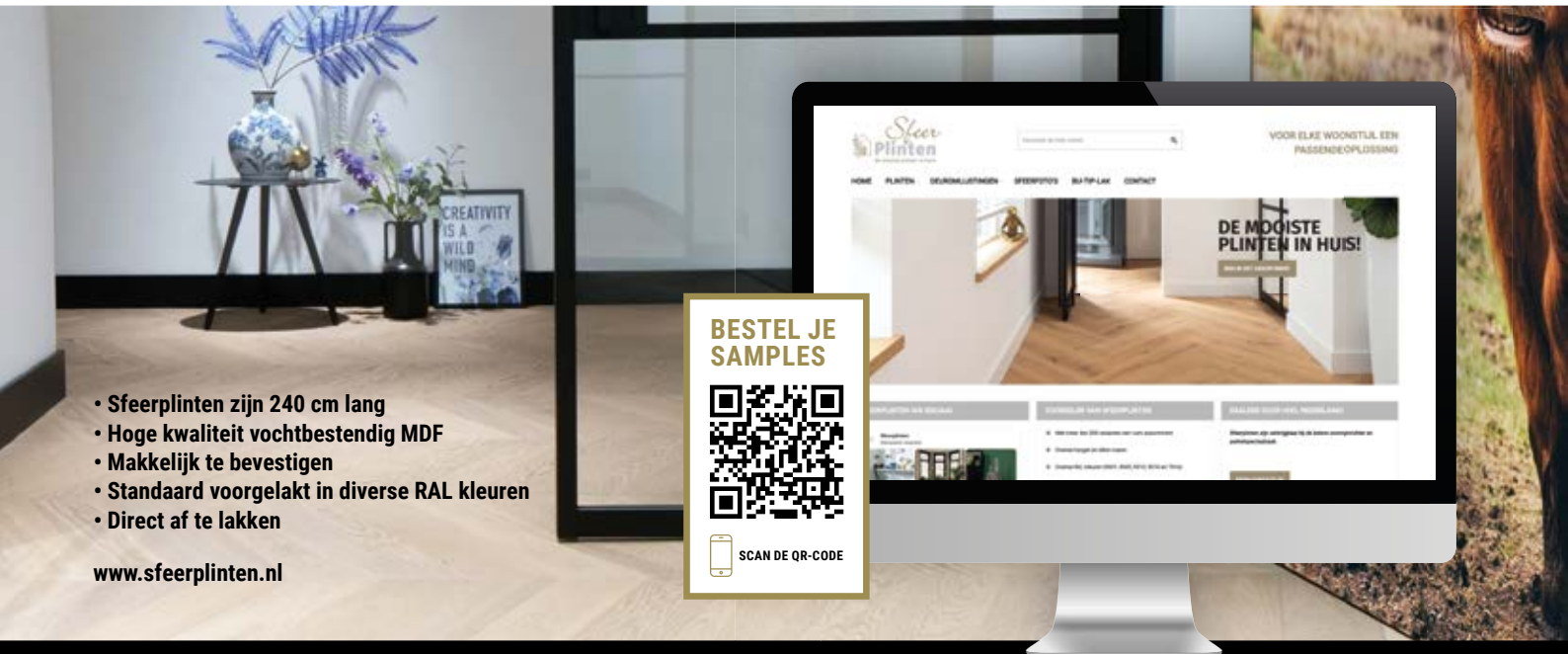

- Sfeerplinten zijn 240 cm lang
- Hoge kwaliteit vochtbestendig MDF
- Makkelijk te bevestigen
- Standaard voorgelakt in diverse RAL kleuren
- Direct af te lakken

www.sfeerplinten.nl

BESTEL JE
SAMPLES



SCAN DE QR-CODE

MODERNE PLINT | EEN STATEMENT MET STRAK DESIGN

RAL 9016 VERKEERSWIT

| Hoogte mm | Dikte mm | Artikelnr. |
|-----------|----------|------------|
| 55 | 9 | 15970 |
| 70 | 9 | 15971 |
| 90 | 9 | 15972 |
| 55 | 12 | 15973 |
| 70 | 12 | 15948 |
| 90 | 12 | 15949 |
| 120 | 12 | 15950 |
| 150 | 12 | 15960 |
| 70 | 15 | 15951 |
| 70 | 15 | 16344 |
| 90 | 15 | 15952 |
| 90 | 15 | 16345 |
| 120 | 15 | 15953 |
| 150 | 15 | 15961 |
| 70 | 18 | 15962 |
| 90 | 18 | 15963 |
| 90 | 18 | 15975 |
| 120 | 18 | 15964 |
| 150 | 18 | 15965 |

RAL 9010 ZUIVER WIT

| Hoogte mm | Dikte mm | Artikelnr. |
|-----------|----------|------------|
| 55 | 9 | 16104 |
| 70 | 9 | 16105 |
| 90 | 9 | 16106 |
| 120 | 9 | 16107 |
| 150 | 9 | 16108 |
| 55 | 12 | 16300 |
| 70 | 12 | 16030 |
| 90 | 12 | 16028 |
| 120 | 12 | 16029 |
| 150 | 12 | 16026 |
| 70 | 15 | 16031 |
| 70 | 15 | 16331 |
| 90 | 15 | 16032 |
| 90 | 15 | 16332 |
| 120 | 15 | 16033 |
| 120 | 15 | 16333 |
| 150 | 15 | 16038 |
| 190 | 15 | 16039 |

RAL 9010 ZUIVER WIT

| Hoogte mm | Dikte mm | Artikelnr. |
|-----------|----------|------------|
| 70 | 18 | 16040 |
| 70 | 18 | 16340 |
| 90 | 18 | 16041 |
| 90 | 18 | 16341 |
| 90 | 18 | 16022 |
| 120 | 18 | 16034 |
| 120 | 18 | 16021 |
| 150 | 18 | 16035 |
| 220 | 18 | 16037 |

 Een aantal Sfeerplinten wordt geleverd met een uitsparing aan de onderzijde voor een contactgeluids-reducerende strip.

 De Sfeerplinten met dit icoon hebben een uitsparing aan de achterzijde om over een oude plint, (standaard bouwplint 58 x 12 mm) heen te plaatsen.

RAL 9005 GITZWART

| Hoogte mm | Dikte mm | Artikelnr. |
|-----------|----------|------------|
| 55 | 9 | 15966 |
| 70 | 9 | 15967 |
| 90 | 9 | 15968 |
| 55 | 12 | 15969 |
| 70 | 12 | 15936 |
| 90 | 12 | 15937 |
| 120 | 12 | 15938 |
| 150 | 12 | 15942 |
| 70 | 15 | 15939 |
| 70 | 15 | 16342 |
| 90 | 15 | 15940 |
| 90 | 15 | 16343 |
| 120 | 15 | 15941 |
| 150 | 15 | 15943 |
| 70 | 18 | 15944 |
| 90 | 18 | 15945 |
| 90 | 18 | 15974 |
| 120 | 18 | 15946 |
| 150 | 18 | 15947 |

RAL 9001 CRÈME WIT

| Hoogte mm | Dikte mm | Artikelnr. |
|-----------|----------|------------|
| 70 | 12 | 15924 |
| 90 | 12 | 15925 |
| 120 | 12 | 15926 |
| 70 | 15 | 15927 |
| 90 | 15 | 15928 |
| 120 | 15 | 15929 |



RAL 7016 ANTRACIET

| Hoogte mm | Dikte mm | Artikelnr. |
|-----------|----------|------------|
| 70 | 12 | 15954 |
| 90 | 12 | 15955 |
| 120 | 12 | 15956 |
| 70 | 15 | 15957 |
| 90 | 15 | 15958 |
| 120 | 15 | 15959 |





7.1.1 SFEEPLINTEN, MDF, KUNSTSTOF EN FLEXIBEL (vervolg)

Sfeerplinten zijn 240 cm lang

| Watervaste kunststof moderne plint wit | Hoogte mm | Dikte mm | Artikelnr. |
|---|-----------|----------|------------|
|  | 70 | 12 | 16730 |
| | 90 | 12 | 16728 |
| | 70 | 15 | 16731 |
| | 90 | 15 | 16732 |

| Flexibele moderne plint wit RAL 9010 | Hoogte mm | Dikte mm | Lengte cm | Artikelnr. |
|--|-----------|----------|-----------|------------|
|  | 70/90/120 | 12 | 200 | 16044 |
| | 70/90/120 | 15 | 200 | 16045 |
| Deze plint kan ingekort worden tot een hoogte van 70 of 90 mm, door op de achterkant in te snijden | | | | |

| Koloniale plint wit RAL 9010 | Hoogte mm | Dikte mm | Artikelnr. |
|--|-----------|----------|------------|
|  | 60 | 12 | 16011 |
| | 90 | 12 | 16010 |
| | 70 | 15 | 16002 |
| | 90 | 15 | 16003 |
| | 120 | 15 | 16004 |
| | 76 | 18 | 16012 |
| | 120 | 18 | 16014 |
| | 58 | 22 | 16013 |

| Klassieke renovatieplint wit RAL 9010 | Hoogte mm | Dikte mm | Artikelnr. |
|---|---------------------------|----------|------------|
|  | 85 | 22 | 16023 |
| | De uitsparing is 60x13 mm | | |
| | 85 | 22 | 16323 |
| | De uitsparing is 60x13 mm | | |
|  | 120 | 22 | 16024 |
| | De uitsparing is 90x13 mm | | |
| Kunststof kabelkanaal 30x12 wit | | | 16025 |

| Eigentijdse plint wit RAL 9010 | Hoogte mm | Dikte mm | Artikelnr. |
|---|-----------|----------|------------|
|  | 70 | 12 | 16046 |
| | 90 | 12 | 16047 |
| | 120 | 12 | 16048 |
| | 70 | 15 | 16015 |
| | 90 | 15 | 16017 |
| | 120 | 15 | 16018 |
| | 150 | 15 | 16019 |
| | 70 | 18 | 16049 |
| | 90 | 18 | 16050 |
| | 115 | 18 | 16016 |
| | 150 | 18 | 16051 |

| Tijdloze plint wit RAL 9010 | Hoogte mm | Dikte mm | Artikelnr. |
|--|-----------|----------|------------|
|  | 70 | 12 | 16090 |
| | 90 | 12 | 16091 |
| | 120 | 12 | 16092 |
| | 70 | 15 | 16089 |
| | 90 | 15 | 16093 |
| | 120 | 15 | 16094 |
| | 90 | 18 | 16096 |
| | 120 | 18 | 16097 |

| Retro plint wit RAL 9010 | Hoogte mm | Dikte mm | Artikelnr. |
|--|-----------|----------|------------|
|  | 70 | 15 | 16020 |

| Barok plint wit RAL 9010 | Hoogte mm | Dikte mm | Artikelnr. |
|---|-----------|----------|------------|
|  | 120 | 15 | 16060 |
| | 150 | 18 | 16062 |

| Renaissance plint wit RAL 9010 | Hoogte mm | Dikte mm | Artikelnr. |
|--|-----------|----------|------------|
|  | 120 | 15 | 16066 |
| | 150 | 18 | 16068 |
| | 190 | 18 | 16069 |

| Romantische plint wit RAL 9010 | Hoogte mm | Dikte mm | Artikelnr. |
|--|-----------|----------|------------|
|  | 120 | 15 | 16053 |
| | 150 | 18 | 16055 |

| Contactgeluidreducerende strip  | Lengte | Artikelnr. |
|--|--------|------------|
|  Wit | 25 m | 16121 |
|  Zwart | 25 m | 16122 |
|  Lichtbruin | 25 m | 16125 |
|  Donkerbruin | 25 m | 16126 |



KITTEN OP KLEUR
Bijpassende kleuren voor het afkitten van de plinten vind je in hoofdstuk 3: Lijmen & Kit > 3.8 Kitten op kleur of kijk in onze webshop

7.1.2 BIJ-TIP-LAK

| Overig | Inhoud | Artikelnr. |
|---|--------------------------|------------|
|  | Sfeerplinten bij-tip-lak | 20 ml |
| | RAL 9001 | 16194 |
| | RAL 9005 | 16192 |
| | RAL 9010 | 16191 |
| | RAL 9016 | 16193 |
| | RAL 7016 | 16195 |
| | | |



7.1.3 HOEK/EINDSTUK VOOR MDF PLINT

| Hoek/eindstuk voor MDF plint | Hoogte mm | Dikte mm | Zuiver wit RAL 9010 | Crème wit RAL 9001 | Verkeerswit RAL 9016 | Gitzwart RAL 9005 | Antracietgrijs RAL 7016 |
|---|-----------|----------|---------------------|--------------------|----------------------|-------------------|-------------------------|
|  | 55 | 9 | 16501 | | 16508 | 16509 | |
| | 70 | 9 | 16502 | | 16510 | 16511 | |
| | 90 | 9 | 16503 | | 16512 | 16513 | |
| | 120 | 9 | 16504 | | 16514 | 16515 | |
| | 150 | 9 | 16505 | | 16516 | 16517 | |
| | 55 | 12 | 16506 | | | | |
| | 60 | 12 | 16370 | | | | |
| | 70 | 12 | 16371 | 16162 | 16168 | 16174 | 16185 |
| | 90 | 12 | 16372 | 16163 | 16169 | 16175 | 16186 |
| | 120 | 12 | 16373 | 16164 | 16170 | 16176 | 16187 |
| | 150 | 12 | 16507 | | 16535 | 16524 | |
| | 70 | 15 | 16374 | 16165 | 16171 | 16177 | 16188 |
| | 90 | 15 | 16375 | 16166 | 16172 | 16178 | 16189 |
| | 120 | 15 | 16376 | 16167 | 16173 | 16179 | 16190 |
| | 150 | 15 | 16377 | | 16536 | 16525 | |
| | 190 | 15 | 16378 | | | | |
| | 70 | 18 | 16379 | | 16537 | 16526 | |
| | 90 | 18 | 16380 | | 16538 | 16527 | |
| | 120 | 18 | 16381 | | 16539 | 16528 | |
| | 150 | 18 | 16382 | | 16540 | 16529 | |
| 190 | 18 | 16383 | | | | | |
| 220 | 18 | 16384 | | | | | |
| 85 | 22 | 16385 | | | | | |
| 120 | 22 | 16386 | | | | | |

Verstek zagen is niet meer noodzakelijk, hoek/eindstukken versnellen de installatie. De hoekstukken steken standaard 3 mm uit boven de plint en zijn 3 mm dikker.



Sfeer Plinten



de mooiste plinten in huis!



7





7.1.4 NEUTEN EN ARCHITRAVEN

| Neuten wit RAL 9010 | | Artikelnr. |
|---|--|------------|
|  | Retro neut 50x10 cm | 16074 |
|  | Traditionele neut (aflopend) 50x10,5 cm | 16075 |
|  | Moderne neut 50 cm (75x18) | 16076 |

Neuten zijn 50 cm lang en zijn aan beide kopse kanten afgewerkt, zodat je er 2 stuks uit kunt halen.

| Moderne architraaf wit RAL 9010 | Hoogte mm | Dikte mm | Lengte cm | Artikelnr. |
|---|--------------|-------------|--------------|------------|
|  | 70 | 12 | 270 | 16072 |

| Koloniale architraaf wit RAL 9010 | Hoogte mm | Dikte mm | Lengte cm | Artikelnr. |
|---|--------------|-------------|--------------|------------|
|  | 68 | 12 | 244 | 16070 |

| Klassieke architraaf wit RAL 9010 | Hoogte mm | Dikte mm | Lengte cm | Artikelnr. |
|---|--------------|-------------|--------------|------------|
|  | 70 | 15 | 270 | 16071 |

| Barok architraaf wit RAL 9010 | Hoogte mm | Dikte mm | Lengte cm | Artikelnr. |
|---|--------------|-------------|--------------|------------|
|  | 70 | 12 | 244 | 16079 |

| Renaissance architraaf wit RAL 9010 | Hoogte mm | Dikte mm | Lengte cm | Artikelnr. |
|---|--------------|-------------|--------------|------------|
|  | 88 | 18 | 244 | 16078 |

| Romantische architraaf wit RAL 9010 | Hoogte mm | Dikte mm | Lengte cm | Artikelnr. |
|---|--------------|-------------|--------------|------------|
|  | 90 | 16 | 244 | 16073 |

7.1.5 MDF WIT GEGRONDE PLINTEN

| MDF plint wit gegronde recht | Hoogte mm | Dikte mm | Lengte cm | Artikelnr. |
|--|--------------|-------------|--------------|------------|
|  | 70 | 12 | 240 | 16397 |
| | 90 | 12 | 240 | 16398 |
| | 120 | 12 | 240 | 16399 |
| | 70 | 15 | 240 | 16401 |
| | 90 | 15 | 240 | 16402 |
| | 120 | 15 | 240 | 16403 |
| | 70 | 18 | 240 | 16406 |
| | 90 | 18 | 240 | 16407 |
| | 120 | 18 | 240 | 16408 |

7.1.6 WIT GEFOLIEDE PLINTEN

| Plint recht wit gefolied | Hoogte mm | Dikte mm | Lengte cm | Artikelnr. |
|---|--------------|-------------|--------------|------------|
|  | 60 | 12 | 240 | 16248 |
| | 70 | 12 | 240 | 16249 |
| | 90 | 12 | 240 | 16250 |
| | 120 | 12 | 240 | 16247 |
| | 60 | 15 | 240 | 16251 |
| | 70 | 15 | 240 | 16252 |
| | 90 | 15 | 240 | 16253 |
| | 120 | 15 | 240 | 16254 |
| | 60 | 18 | 240 | 16257 |
| | 70 | 18 | 240 | 16255 |
| | 90 | 18 | 240 | 16256 |
| | 120 | 18 | 240 | 16258 |

7.1.7 ZWART GEFOLIEDE PLINTEN

| Plint recht zwart gefolied | Hoogte mm | Dikte mm | Lengte cm | Artikelnr. |
|--|--------------|-------------|--------------|------------|
|  | 70 | 12 | 240 | 16277 |
| | 90 | 12 | 240 | 16278 |
| | 120 | 12 | 240 | 16279 |
| | 70 | 15 | 240 | 16281 |
| | 90 | 15 | 240 | 16282 |
| | 120 | 15 | 240 | 16283 |

7.1.8 MERANTI HARDHOUT PLINTEN EN KOPLATTEN

| Meranti plint recht wit geground | Hoogte mm | Dikte mm | Lengte cm | Artikelnr. |
|---|-----------|----------|-----------|------------|
|  | 45 | 9 | 242 | 16444 |
| | 55 | 12 | 242 | 16445 |
| | 70 | 12 | 242 | 16446 |
| | 90 | 12 | 242 | 16447 |
| | 120 | 12 | 242 | 16448 |

| Meranti koplat recht wit geground | Hoogte mm | Dikte mm | Lengte cm | Artikelnr. |
|---|-----------|----------|-----------|------------|
|  | 45 | 12 | 242 | 16440 |
| | 68 | 12 | 242 | 16442 |

| Meranti koplat schuin wit geground | Hoogte mm | Dikte mm | Lengte cm | Artikelnr. |
|--|-----------|----------|-----------|------------|
|  | 45 | 12 | 242 | 16441 |
| | 68 | 12 | 242 | 16443 |

7.2 DÖLLKEN PLINTEN



| Kernplint cubu | Hoogte mm | Dikte mm | Lengte cm | Artikelnr. |
|---------------------|-----------|----------|-----------|------------|
| Wit RAL 9010 | 40 | 13 | 250 | 20101 |
| | 60 | 13 | 250 | 20102 |
| | 80 | 13 | 250 | 20103 |
| | 100 | 13 | 250 | 20104 |
| | 60 | 19 | 250 | 20116 |
| | 80 | 19 | 250 | 20110 |
| Lichtgrijs | 40 | 13 | 250 | 20122 |
| | 60 | 13 | 250 | 20128 |
| | 80 | 13 | 250 | 20129 |
| | 100 | 13 | 250 | 20130 |
| | 60 | 19 | 250 | 20131 |
| | 80 | 19 | 250 | 20134 |
| Antraciet | 40 | 13 | 250 | 20135 |
| | 60 | 13 | 250 | 20138 |
| | 80 | 13 | 250 | 20139 |
| | 100 | 13 | 250 | 20140 |
| Zwart | 60 | 13 | 250 | 20118 |
| | 80 | 13 | 250 | 20119 |
| | 100 | 13 | 250 | 20120 |

7.3 ALUMINIUM

ALUMINIUM



Aluminium rechte plint

Kleur Artikelnr.



Rechte plint
60x15 mm
Lengte 250 cm

Geborsteld RVS 18021
Zilver 18011



Binnenhoek

Geborsteld RVS 18022
Zilver 18012



Buitenhoek

Geborsteld RVS 18023
Zilver 18013



Eindstuk links

Geborsteld RVS 18024
Zilver 18014



Eindstuk rechts

Geborsteld RVS 18025
Zilver 18015



Koppelstuk

Geborsteld RVS 18026
Zilver 18016

Gebogen plint voor PVC

Artikelnr.

Deze plint is op twee manieren toe te passen:

1. Plaats de plint met de vlakke zijde naar voren, waardoor je een moderne aluminium plint ziet.
2. Draai de plint om, dan kun je er een strook PVC of linoleum (tot een dikte van 3 mm) in plaatsen, hierdoor past de plint goed bij de vloer.



Aluminium gebogen plint
RVS 60x15 mm
Lengte 250 cm

18051



Binnenhoek
voor gebogen RVS plint

18052



Buitenhoek
voor gebogen RVS plint

18053



Eindstuk links
voor gebogen RVS plint

18054



Eindstuk rechts
voor gebogen RVS plint

18055



Koppelstuk
voor gebogen RVS plint

18056



RANDAFWERKING IN 175 KLEUREN FOLIE

PPC biedt met het folie assortiment een ruime keuze aan randafwerkingen voor een breed scala aan merken laminaat en PVC. Maar het kiezen van een plint die past bij de kleur van jouw gekozen vloer is niet altijd eenvoudig. Om het je gemakkelijker te maken heeft PPC bij alle grote merken laminaat en PVC alvast de best bijpassende randafwerking gezocht en verwerkt in een handige tool: de plintzoeker.

Met de plintzoeker vind je in drie stappen de juiste plint. Ook bijbehorende accessoires zoals rozetten, hoeklijnen en dilatatieprofielen in hetzelfde decor worden direct getoond.

HOE WERKT DE PLINTZOEKER?

Scan de QR-code en volg de stappen.

- 1 Merk**
Kies het merk van de gekozen vloer
- 2 Vloernaam**
Kies de naam van de gekozen vloer
- 3 Randafwerking**
Bestel direct de bijpassende plint



RECHTE FOLIEPLINT
70 x 14 MM*



DILATATIEPROFIEL
38 MM ZELFKLEVENDE



AFWERKPLINT
MET PLAKSTRIP 5 x 24 MM

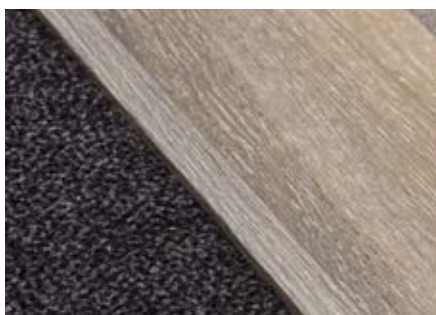

HOEKLIJNPROFIEL
10 MM ZELFKLEVENDE



DUO-HOEKLIJNPROFIEL
24,5 x 30 MM ZELFKLEVENDE



ROZET UNIVERSEEL
ZELFKLEVENDE

Ø Binnen 17 mm / Ø Buiten 55 mm

* voor de rechte folieplint en de systeemplint zijn tevens bijpassende hoekstukken beschikbaar.

7.4 FOLIE PLINTEN EN PROFIELEN

| | Foliekleur | Rechte folieplint | Hoek/eindstuk | Afwerklijst met plakstrip | Zelfklevende rozet | Dilatatieprofiel zelfklevend | Hoeklijnprofiel zelfklevend | Duo-hoeklijnprofiel zelfklevend |
|------------------------------|------------|-------------------|---------------------|---------------------------|---------------------|------------------------------|-----------------------------|---------------------------------|
| Formaat HxB mm Lengte cm | | 70x14 240 | 17x17x73 4 stuks | 24x5 240 | Ø 17-22 10 stuks | 38 200 | 24,5x10 200 | 24,5x30 200 |
| Oud eiken mat geolied | | 27002 | 27402 | 23002 | 24002 | 40002 | 63002 | 67002 |
| Prestige eiken | | 27003 | 27403 | 23003 | 24003 | 40003 | 63003 | 67003 |
| Vintage eik natuurvernist | | 27004 | 27404 | 23004 | 24004 | 40004 | 63004 | 67004 |
| Eiken wit | | 27005 | 27405 | 23005 | 24005 | 40005 | 63005 | 67005 |
| Eiken wit ceruse | | 27006 | 27406 | 23006 | 24006 | 40006 | 63006 | 67006 |
| Eiken donker vernist | | 27007 | 27407 | 23007 | 24007 | 40007 | 63007 | 67007 |
| Eiken diamant | | 27009 | 27409 | 23009 | 24009 | 40009 | 63009 | 67009 |
| Eiken select | | 27010 | 27410 | 23010 | 24010 | 40010 | 63010 | 67010 |
| Eiken donker | | 27011 | 27411 | 23011 | 24011 | 40011 | 63011 | 67011 |
| Eiken | | 27012 | 27412 | 23012 | 24012 | 40012 | 63012 | 67012 |
| Eiken licht | | 27013 | 27413 | 23013 | 24013 | 40013 | 63013 | 67013 |
| Eiken polar | | 27014 | 27414 | 23014 | 24014 | 40014 | 63014 | 67014 |
| Eiken oudfrans | | 27017 | 27417 | 23017 | 24017 | 40017 | 63017 | 67017 |
| Eiken antiek | | 27018 | 27418 | 23018 | 24018 | 40018 | 63018 | 67018 |
| Eiken rood | | 27019 | 27419 | 23019 | 24019 | 40019 | 63019 | 67019 |
| Eiken wit geolied | | 27020 | 27420 | 23020 | 24020 | 40020 | 63020 | 67020 |
| Beuken licht | | 27023 | 27423 | 23023 | 24023 | 40023 | 63023 | 67023 |
| Beuken select | | 27025 | 27425 | 23025 | 24025 | 40025 | 63025 | 67025 |
| Ahorn donker | | 27031 | 27431 | 23031 | 24031 | 40031 | 63031 | 67031 |
| Ahorn | | 27032 | 27432 | 23032 | 24032 | 40032 | 63032 | 67032 |
| Metallic slate | | 27039 | 27439 | 23039 | 24039 | 40039 | 63039 | 67039 |
| Kersen donker | | 27041 | 27441 | 23041 | 24041 | 40041 | 63041 | 67041 |
| Kersen licht | | 27043 | 27443 | 23043 | 24043 | 40043 | 63043 | 67043 |
| Oud kastanje | | 27044 | 27444 | 23044 | 24044 | 40044 | 63044 | 67044 |
| Kersen | | 27045 | 27445 | 23045 | 24045 | 40045 | 63045 | 67045 |
| Kersen select | | 27046 | 27446 | 23046 | 24046 | 40046 | 63046 | 67046 |
| Titanium eik | | 27047 | 27447 | 23047 | 24047 | 40047 | 63047 | 67047 |
| Country eik grijs | | 27048 | 27448 | 23048 | 24048 | 40048 | 63048 | 67048 |
| Franse eik grijsvernist | | 27049 | 27449 | 23049 | 24049 | 40049 | 63049 | 67049 |
| Witte es | | 27050 | 27450 | 23050 | 24050 | 40050 | 63050 | 67050 |
| Eiken naturel | | 27052 | 27452 | 23052 | 24052 | 40052 | 63052 | 67052 |
| Eiken grijs gerookt | | 27053 | 27453 | 23053 | 24053 | 40053 | 63053 | 67053 |
| Eiken natuur geolied | | 27055 | 27455 | 23055 | 24055 | 40055 | 63055 | 67055 |
| Eiken donker geolied | | 27056 | 27456 | 23056 | 24056 | 40056 | 63056 | 67056 |
| Vintage eiken donker vernist | | 27057 | 27457 | 23057 | 24057 | 40057 | 63057 | 67057 |













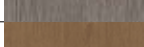
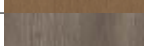
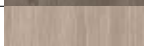

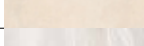

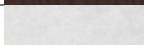



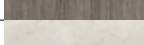
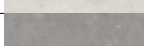

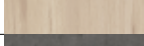
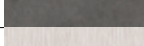

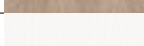
7.4 FOLIE PLINTEN EN PROFIELEN (vervolg)

| | Foliekleur | Rechte folieplint | Hoek/eindstuk | Atwerklijst met plakstrip | Zelfklevende rozet | Dilatatieprofiel zelfklevend | Hoeklijprofiel zelfklevend | Duo-hoeklijprofiel zelfklevend |
|-----------------------------|------------|-------------------|---------------------|---------------------------|---------------------|------------------------------|----------------------------|--------------------------------|
| Formaat HxB mm Lengte cm | | 70x14 240 | 17x17x73 4 stuks | 24x5 240 | Ø 17-22 10 stuks | 38 200 | 24,5x10 200 | 24,5x30 200 |
| Xenon | | 27060 | 27460 | 23060 | 24060 | 40060 | 63060 | 67060 |
| Elzen wit | | 27062 | 27462 | 23062 | 24062 | 40062 | 63062 | 67062 |
| Teak grijs geborsteld | | 27063 | 27463 | 23063 | 24063 | 40063 | 63063 | 67063 |
| Wit noten | | 27064 | 27464 | 23064 | 24064 | 40064 | 63064 | 67064 |
| Seagrass | | 27065 | 27465 | 23065 | 24065 | 40065 | 63065 | 67065 |
| Newcastle eiken grijs | | 27066 | 27466 | 23066 | 24066 | 40066 | 63066 | 67066 |
| Newport mahonie | | 27068 | 27468 | 23068 | 24068 | 40068 | 63068 | 67068 |
| Landhuis merbau | | 27069 | 27469 | 23069 | 24069 | 40069 | 63069 | 67069 |
| Afzelia gebleekt | | 27070 | 27470 | 23070 | 24070 | 40070 | 63070 | 67070 |
| Mahonie | | 27071 | 27471 | 23071 | 24071 | 40071 | 63071 | 67071 |
| Walnoot | | 27073 | 27473 | 23073 | 24073 | 40073 | 63073 | 67073 |
| Wengé zwart | | 27075 | 27475 | 23075 | 24075 | 40075 | 63075 | 67075 |
| Grenen wit | | 27082 | 27482 | 23082 | 24082 | 40082 | 63082 | 67082 |
| Klassieke patina eik licht | | 27083 | 27483 | 23083 | 24083 | 40083 | 63083 | 67083 |
| Zwart | | 27091 | 27491 | 23091 | 24091 | 41365 | 69165 | 69465 |
| Beton gepolijst donker | | 27093 | 27493 | 23093 | 24093 | 40093 | 63093 | 67093 |
| Beton gepolijst natuur | | 27094 | 27494 | 23094 | 24094 | 40094 | 63094 | 67094 |
| Marmer | | 27095 | 27495 | 23095 | 24095 | 40095 | 63095 | 67095 |
| Klassieke patina eik grijs | | 27096 | 27496 | 23096 | 24096 | 40096 | 63096 | 67096 |
| Noors eiken | | 27097 | 27497 | 23097 | 24097 | 40097 | 63097 | 67097 |
| Grijs | | 27098 | 27498 | 23098 | 24098 | | | |
| Grijze teak | | 27099 | 27499 | 23099 | 24099 | 40099 | 63099 | 67099 |
| Kasteel eiken | | 27101 | 27501 | 23101 | 24101 | 40101 | 63101 | 67101 |
| Aspen eiken | | 27103 | 27503 | 23103 | 24103 | 40103 | 63103 | 67103 |
| Licht geborsteld eiken | | 27104 | 27504 | 23104 | 24104 | 40104 | 63104 | 67104 |
| Landhuis grenen | | 27105 | 27505 | 23105 | 24105 | 40105 | 63105 | 67105 |
| Dockland oak | | 27107 | 27507 | 23107 | 24107 | 40107 | 63107 | 67107 |
| New england oak | | 27108 | 27508 | 23108 | 24108 | 40108 | 63108 | 67108 |
| Oude rustieke eik | | 27109 | 27509 | 23109 | 24109 | 40109 | 63109 | 67109 |
| Gebleekt eiken | | 27111 | 27511 | 23111 | 24111 | 40111 | 63111 | 67111 |
| Eik whitewash | | 27112 | 27512 | 23112 | 24112 | 40112 | 63112 | 67112 |
| Eiken wit getint | | 27113 | 27513 | 23113 | 24113 | 40113 | 63113 | 67113 |
| Eiken naturel donker | | 27114 | 27514 | 23114 | 24114 | 40114 | 63114 | 67114 |
| Roussillon eiken | | 27117 | 27517 | 23117 | 24117 | 40117 | 63117 | 67117 |
| Wellington eiken | | 27118 | 27518 | 23118 | 24118 | 40118 | 63118 | 67118 |

7.4 FOLIE PLINTEN EN PROFIELEN (vervolg)

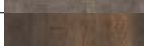
| | Foliekleur | Rechte folieplint | Hoek/eindstuk | Afwerklijst met plakstrip | Zelfklevende rozet | Dilatatieprofiel zelfklevend | Hoeklijnprofiel zelfklevend | Duo-hoeklijnprofiel zelfklevend |
|-----------------------------|------------|-------------------|---------------------|---------------------------|---------------------|------------------------------|-----------------------------|---------------------------------|
| Formaat HxB mm Lengte cm | | 70x14 240 | 17x17x73 4 stuks | 24x5 240 | Ø 17-22 10 stuks | 38 200 | 24,5x10 200 | 24,5x30 200 |
| Champagne eiken | | 27119 | 27519 | 23119 | 24119 | 40119 | 63119 | 67119 |
| Eiken blauwgrijs | | 27120 | 27520 | 23120 | 24120 | 40120 | 63120 | 67120 |
| Zand licht | | 27122 | 27522 | 23122 | 24122 | 40122 | 63122 | 67122 |
| Zand donker | | 27123 | 27523 | 23123 | 24123 | 40123 | 63123 | 67123 |
| Eiken geschraapt grijs | | 27125 | 27525 | 23125 | 24125 | 40125 | 63125 | 67125 |
| Eiken geborsteld bruin | | 27127 | 27527 | 23127 | 24127 | 40127 | 63127 | 67127 |
| Vulcaan eiken | | 27128 | 27528 | 23128 | 24128 | 40128 | 63128 | 67128 |
| Traditional oak | | 27129 | 27529 | 23129 | 24129 | 40129 | 63129 | 67129 |
| Dekkend antraciet | | 27130 | 27530 | 23130 | 24130 | | | |
| Eiken wit gerookt mat | | 27131 | 27531 | 23131 | 24131 | 40131 | 63131 | 67131 |
| Rustiek pine | | 27132 | 27532 | 23132 | 24132 | 40132 | 63132 | 67132 |
| Trendy zwart | | 27134 | 27534 | 23134 | 24134 | 40134 | 63134 | 67134 |
| Zwart geolied | | 27135 | 27535 | 23135 | 24135 | 40135 | 63135 | 67135 |
| Zwart hoogglans | | 27136 | 27536 | 23136 | 24136 | 41365* | 69165* | 69565* |
| Fijngestreept eiken licht | | 27137 | 27537 | 23137 | 24137 | 40137 | 63137 | 67137 |
| Verweerd grenen | | 27138 | 27538 | 23138 | 24138 | 40138 | 63138 | 67138 |
| Fijngestreept eiken naturel | | 27139 | 27539 | 23139 | 24139 | 40139 | 63139 | 67139 |
| Eiken donkerbruin geolied | | 27140 | 27540 | 23140 | 24140 | 40140 | 63140 | 67140 |
| Strandhuis grijs | | 27141 | 27541 | 23141 | 24141 | 40141 | 63141 | 67141 |
| Tegel grijs | | 27142 | 27542 | 23142 | 24142 | 40142 | 63142 | 67142 |
| Tegel blauw | | 27143 | 27543 | 23143 | 24143 | | | |
| Hoogglans wit | | 27144 | 27544 | 23144 | 24144 | 41385* | 69185* | |
| Eiken vergrijsd | | 27145 | 27545 | 23145 | 24145 | 40145 | 63145 | 67145 |
| Eiken grijs geolied | | 27146 | 27546 | 23146 | 24146 | 40146 | 63146 | 67146 |
| Antiek eiken beige | | 27147 | 27547 | 23147 | 24147 | 40147 | 63147 | 67147 |
| Modern eiken bruin | | 27148 | 27548 | 23148 | 24148 | 40148 | 63148 | 67148 |
| Geloogd grenen sneeuw | | 27149 | 27549 | 23149 | 24149 | 40149 | 63149 | 67149 |
| Oud grenen gekalkt | | 27150 | 27550 | 23150 | 24150 | 40150 | 63150 | 67150 |
| Oud eiken licht | | 27151 | 27551 | 23151 | 24151 | 40151 | 63151 | 67151 |
| Canadees eiken geborsteld | | 27152 | 27552 | 23152 | 24152 | 40152 | 63152 | 67152 |
| Grenen geborsteld bruin | | 27153 | 27553 | 23153 | 24153 | 40153 | 63153 | 67153 |
| Belgisch hardsteen | | 27154 | 27554 | 23154 | 24154 | | | |
| Frans oud eiken grijs | | 27155 | 27555 | 23155 | 24155 | 40155 | 63155 | 67155 |
| Gezandstraalde eik natuur | | 27156 | 27556 | 23156 | 24156 | 40156 | 63156 | 67156 |
| Eik grijs met zaagsnede | | 27157 | 27557 | 23157 | 24157 | 40157 | 63157 | 67157 |

7.4 FOLIE PLINTEN EN PROFIELEN (vervolg)

| | Foliekleur | Rechte folieplint | Hoek/eindstuk | Atwerklijst met plakstrip | Zelfklevende rozet | Dilatatieprofiel zelfklevend | Hoeklijprofiel zelfklevend | Duo-hoeklijprofiel zelfklevend |
|-----------------------------|---|-------------------|---------------------|---------------------------|---------------------|------------------------------|----------------------------|--------------------------------|
| Formaat HxB mm Lengte cm | | 70x14 240 | 17x17x73 4 stuks | 24x5 240 | Ø 17-22 10 stuks | 38 200 | 24,5x10 200 | 24,5x30 200 |
| Klassieke eik bruin |  | 27158 | 27558 | 23158 | 24158 | 40158 | 63158 | 67158 |
| Zachte eik warm grijs |  | 27159 | 27559 | 23159 | 24159 | 40159 | 63159 | 67159 |
| Tennessee grijze eik |  | 27161 | 27561 | 23161 | 24161 | 40161 | 63161 | 67161 |
| Eiken zilvergrijs |  | 27162 | 27562 | 23162 | 24162 | 40162 | 63162 | 67162 |
| Eiken gerookt |  | 27163 | 27563 | 23163 | 24163 | 40163 | 63163 | 67163 |
| Eiken drijfhout bruin |  | 27164 | 27564 | 23164 | 24164 | 40164 | 63164 | 67164 |
| Gerookt eiken wit geolied |  | 27165 | 27565 | 23165 | 24165 | 40165 | 63165 | 67165 |
| Licht eiken geolied |  | 27166 | 27566 | 23166 | 24166 | 40166 | 63166 | 67166 |
| Eiken bruin geolied |  | 27167 | 27567 | 23167 | 24167 | 40167 | 63167 | 67167 |
| Tivoli travertin |  | 27169 | 27569 | 23169 | 24169 | 40169 | 63169 | 67169 |
| Engelse eik lichtgrijs |  | 27171 | 27571 | 23171 | 24171 | 40171 | 63171 | 67171 |
| Bosland eik bruin |  | 27172 | 27572 | 23172 | 24172 | 40172 | 63172 | 67172 |
| Palissander zwartvernist |  | 27174 | 27574 | 23174 | 24174 | 40174 | 63174 | 67174 |
| Beton wit |  | 27175 | 27675 | 23175 | 24175 | 40175 | 63175 | 67175 |
| Eiken kaneel |  | 27176 | 27676 | 23176 | 24176 | 40176 | 63176 | 67176 |
| Eiken katoenwit |  | 27178 | 27678 | 23178 | 24178 | 40178 | 63178 | 67178 |
| Oud grenen |  | 27181 | 27581 | 23181 | 24181 | 40181 | 63181 | 67181 |
| Vergrijsd grenen |  | 27182 | 27582 | 23182 | 24182 | 40182 | 63182 | 67182 |
| Beton licht |  | 27183 | 27683 | 23183 | 24183 | 40183 | 63183 | 67183 |
| Beton donkergrijs |  | 27184 | 27684 | 23184 | 24184 | 40184 | 63184 | 67184 |
| Eiken salmiak grijs |  | 27185 | 27685 | 23185 | 24185 | 40185 | 63185 | 67185 |
| Eiken geborsteld |  | 27186 | 27686 | 23186 | 24186 | 40186 | 63186 | 67186 |
| Eiken beige |  | 27187 | 27687 | 23187 | 24187 | 40187 | 63187 | 67187 |
| Leem donker |  | 27188 | 27688 | 23188 | 24188 | 40188 | 63188 | 67188 |
| Kalkwit eiken |  | 27189 | 27689 | 23189 | 24189 | 40189 | 63189 | 67189 |
| Eiken honing |  | 27190 | 27690 | 23190 | 24190 | 40190 | 63190 | 67190 |
| Eiken wit gelakt |  | 27191 | 27691 | 23191 | 24191 | 40191 | 63191 | 67191 |
| Beton grijs |  | 27193 | 27693 | 23193 | 24193 | 40193 | 63193 | 67193 |
| Country eik wit |  | 27194 | 27594 | 23194 | 24194 | 40194 | 63194 | 67194 |
| Natuurlijk eik vergrijsd |  | 27195 | 27595 | 23195 | 24195 | 40195 | 63195 | 67195 |
| Mountain oak vergrijsd |  | 27196 | 27596 | 23196 | 24196 | 40196 | 63196 | 67196 |
| Eik licht beige |  | 27197 | 27597 | 23197 | 24197 | 40197 | 63197 | 67197 |
| Roestbruin | | 27199 | 27599 | 23199 | 24199 | 40199 | 63199 | 67199 |
| Country oak brown | | 27204 | 27604 | 23204 | 24204 | 40204 | 63204 | 67204 |
| Country oak green | | 27205 | 27605 | 23205 | 24205 | 40205 | 63205 | 67205 |

7.4 FOLIE PLINTEN EN PROFIELEN (vervolg)

| | Foliekleur | Rechte folieplint | Hoek/eindstuk | Afwerkijst met plakstrip | Zelfklevende rozet | Dilatatieprofiel zelfklevend | Hoeklijnprofiel zelfklevend | Duo-hoeklijnprofiel zelfklevend |
|-----------------------------|------------|-------------------|---------------------|--------------------------|---------------------|------------------------------|-----------------------------|---------------------------------|
| Formaat HxB mm Lengte cm | | 70x14 240 | 17x17x73 4 stuks | 24x5 240 | Ø 17-22 10 stuks | 38 200 | 24,5x10 200 | 24,5x30 200 |
| Country oak light | | 27206 | 27606 | 23206 | 24206 | 40206 | 63206 | 67206 |
| Scarlet oak dark grey | | 27207 | 27607 | 23207 | 24207 | 40207 | 63207 | 67207 |
| Scarlet oak nature | | 27208 | 27608 | 23208 | 24208 | 40208 | 63208 | 67208 |
| Scarlet oak beige | | 27209 | 27609 | 23209 | 24209 | 40209 | 63209 | 67209 |
| Scarlet oak light grey | | 27210 | 27610 | 23210 | 24210 | 40210 | 63210 | 67210 |
| Castle oak light | | 27211 | 27611 | 23211 | 24211 | 40211 | 63211 | 67211 |
| Valley stone light grey | | 27213 | 27613 | 23213 | 24213 | 40213 | 63213 | 67213 |
| Valley stone light | | 27214 | 27614 | 23214 | 24214 | 40214 | 63214 | 67214 |
| Castle oak grey | | 27215 | 27615 | 23215 | 24215 | 40215 | 63215 | 67215 |
| Castle oak nature | | 27217 | 27617 | 23217 | 24217 | 40217 | 63217 | 67217 |
| Castle oak light grey | | 27218 | 27618 | 23218 | 24218 | 40218 | 63218 | 67218 |
| Jazz grey | | 27220 | 27620 | 23220 | 24220 | 40220 | 63220 | 67220 |
| Cantera green | | 27221 | 27621 | 23221 | 24221 | 40221 | 63221 | 67221 |
| Verdon oak brown | | 27222 | 27622 | 23222 | 24222 | 40222 | 63222 | 67222 |
| Country oak grey | | 27224 | 27624 | 23224 | 24224 | 40224 | 63224 | 67224 |
| Mountain oak black | | 27225 | 27625 | 23225 | 24225 | 40225 | 63225 | 67225 |
| Mountain oak grey | | 27226 | 27626 | 23226 | 24226 | 40226 | 63226 | 67226 |
| Concrete grey | | 27227 | 27627 | 23227 | 24227 | 40227 | 63227 | 67227 |
| Cantera grey | | 27228 | 27628 | 23228 | 24228 | 40228 | 63228 | 67228 |
| Mountain oak light grey | | 27230 | 27630 | 23230 | 24230 | 40230 | 63230 | 67230 |
| Mountain oak beige | | 27231 | 27631 | 23231 | 24231 | 40231 | 63231 | 67231 |
| Mountain oak nature | | 27234 | 27634 | 23234 | 24234 | 40234 | 63234 | 67234 |
| Beton gepolijst koper | | 27235 | 27635 | 23235 | 24235 | 40235 | 63235 | 67235 |
| Minimal lichtgrijs | | 27236 | 27636 | 23236 | 24236 | 40236 | 63236 | 67236 |
| Verouderd eiken naturel | | 27238 | 27638 | 23238 | 24238 | 40238 | 63238 | 67238 |
| Oud eiken bruingrijs | | 27239 | 27639 | 23239 | 24239 | 40239 | 63239 | 67239 |
| Eiken lichtbruin geolied | | 27240 | 27640 | 23240 | 24240 | 40240 | 63240 | 67240 |
| Licht eiken naturel | | 27241 | 27641 | 23241 | 24241 | 40241 | 63241 | 67241 |
| Eiken wit grijs | | 27242 | 27642 | 23242 | 24242 | 40242 | 63242 | 67242 |
| Eiken beige wit | | 27243 | 27643 | 23243 | 24243 | 40243 | 63243 | 67243 |
| Marquant eiken bruin | | 27244 | 27644 | 23244 | 24244 | 40244 | 63244 | 67244 |
| Wit RAL 9016 | | 27247 | 27647 | 23247 | 24247 | 41385 | 69185 | |
| Wit RAL 9010 | | 27248 | 27648 | 23248 | 24248 | | | |
| Wit RAL 9001 | | 27249 | 27649 | 23249 | 24249 | | | |
| Zwart RAL 9005 | | 27250 | 27650 | 23250 | 24250 | 41365 | 69165 | 69465 |

7.5 MASSIEF

7.5.1 PLINTEN, AFWERKLIJSTEN EN ROZETTEN

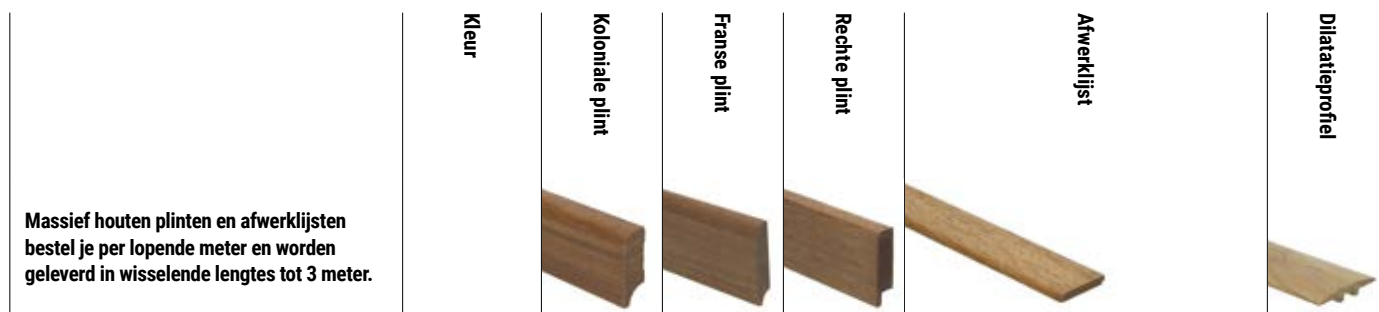

| Formaat HxB mm Lengte cm | 58x22 200-300 | 60x13 200-300 | 54x15 200-300 | 5x23 200-300 | 6x28 200-300 | 6x35 200-300 | 58 (B) 215 |
|--------------------------------|------------------|------------------|------------------|-----------------|-----------------|-----------------|---------------|
| Afzelia/doussié onbewerkt | 11391 | 11596 | 17391 | 11895 | 11991 | 12095 | |
| Afzelia/doussié gelakt | | | | 11896 | 11992 | 12096 | |
| Afzelia/doussié geolied | | | | 11897 | 11993 | 12097 | |
| Ahorn onbewerkt | 11341 | 11541 | 17341 | 11841 | 11941 | 12041 | |
| Ahorn gelakt | | | | 11842 | 11942 | 12042 | |
| Ahorn geolied | | | | 11843 | 11943 | 12043 | |
| Eiken onbewerkt | 11311 | 11511 | 17311 | 11811 | 11911 | 12011 | 42011 |
| Eiken extra rustiek onbewerkt | 11011 | | | | | | |
| Eiken gelakt | 11312 | 11512 | 17312 | 11812 | 11912 | 12012 | |
| Eiken geolied | 11313 | 11513 | 17313 | 11813 | 11913 | 12013 | |
| Eiken wit geolied | 11314 | 11514 | 17314 | 11814 | 11914 | 12014 | |
| Essen onbewerkt | 11331 | 11531 | 17331 | 11831 | 11931 | 12031 | |
| Gestoomd beuken onbewerkt | 11321 | 11521 | 17321 | 11821 | 11921 | 12021 | |
| Gestoomd beuken gelakt | | | | 11822 | 11922 | 12022 | |
| Gestoomd beuken geolied | | | | 11823 | 11923 | 12023 | |
| Grenen onbewerkt | 11351 | 11551 | 17351 | 11851 | 11951 | 12051 | |
| Grenen gelakt | | | | 11852 | 11952 | 12052 | |
| Grenen geolied | | | | 11853 | 11953 | 12053 | |
| Jatoba onbewerkt | 11335 | 11535 | 17335 | 11835 | 11935 | 12035 | |
| Jatoba gelakt | | | | 11836 | 11936 | 12036 | |
| Jatoba geolied | | | | 11837 | 11937 | 12037 | |
| Kambala/afroformosia onbewerkt | 11385 | 11566 | 17385 | 11861 | 11961 | 12061 | |
| Kambala/afroformosia gelakt | | | | 11862 | 11962 | 12062 | |
| Kambala/afroformosia geolied | | | | 11863 | 11963 | 12063 | |
| Licht beuken onbewerkt | 11371 | 11571 | 17371 | 11871 | 11971 | 12071 | |
| Licht beuken gelakt | | | | 11872 | 11972 | 12072 | |
| Licht beuken geolied | | | | 11873 | 11973 | 12073 | |
| Mahonie/sipo onbewerkt | 11381 | 11601 | 17381 | 11886 | 11995 | 12081 | |
| Merbau onbewerkt | 11355 | | | 11891 | 11981 | 12091 | |
| Merbau geolied | | | | 11893 | 11983 | 12093 | |

Voor meer bewerkte eiken afwerkljsten, zie volgende pagina

7.5.1 PLINTEN, AFWERKLIJSTEN EN ROZETTEN (vervolg)

Massief houten plinten en afwerklijsten bestel je per lopende meter en worden geleverd in wisselende lengtes tot 3 meter.

Kleur

Afwerklijst



| Formaat HxB mm Lengte cm | 6x28 200-300 |
|--|-----------------|
| Eiken Skylt-look geolied | 11701 |
| Eiken Skylt gelakt | 11707 |
| Eiken naturel wit geolied | 11916 |
| Eiken wit invisible geolied | 11917 |
| Eiken licht dekkend grijs geolied | 11956 |
| Eiken lichtgrijs geolied | 11907 |
| Eiken grijs geolied | 11705 |
| Eiken bruin geolied | 11703 |
| Eiken chocolade bruin geolied | 11706 |
| Eiken dekkend wit geolied | 11702 |
| Eiken dekkend zwart geolied | 11704 |
| Eiken extra wit geolied | 11957 |
| Eiken enkel gerookt extra wit geolied | 11955 |
| Eiken enkel gerookt licht wit geolied | 11954 |
| Eiken gerookt onbehandeld | 11709 |
| Eiken gerookt naturel geolied | 11715 |
| Eiken gerookt wit geolied | 11716 |
| Eiken gerookt extra wit geolied | 11919 |
| Eiken gerookt grijs geolied | 11718 |
| Eiken dubbel gerookt onbehandeld | 11710 |
| Eiken dubbel gerookt grijs geolied | 11708 |
| Eiken dubbel gerookt naturel geolied | 11719 |
| Eiken dubbel gerookt naturelwit geolied | 11918 |
| Eiken dubbel gerookt wit geolied | 11720 |
| Eiken dubbel gerookt donkergrijs geolied | 11915 |

Massief houten plinten en afwerklijsten bestel je per lopende meter en worden geleverd in wisselende lengtes tot 3 meter.

Kleur

Koloniale plint



| Formaat HxB mm Lengte cm | 58x22 200-300 |
|----------------------------------|------------------|
| Eiken Skylt-look geolied | 11001 |
| Eiken Skylt gelakt | 11007 |
| Eiken gerookt onbehandeld | 11009 |
| Eiken dubbel gerookt onbehandeld | 11010 |



Massief houten plinten en afwerklijsten bestel je per lopende meter en worden geleverd in wisselende lengtes tot 3 meter.

Kleur

Eind- en afwerkprofiel

Holle afwerklijst

Hoge koloniale plint

Rozet

Rozet

Duo-rozet variabel

Duo-rozet variabel

Dubbele rozet zonder boorgat



| Formaat HxB mm Lengte cm | 38 (B) 215 | 30x30 200-300 | 100x20 200-300 | Ø 16 mm | Ø 22 mm | Ø 16 mm | Ø 22 mm | 110x50 |
|-------------------------------|---------------|------------------|-------------------|---------|---------|---------|---------|--------|
| Eiken onbewerkt | 62011 | 14111 | 11411 | 81110 | 81210 | 81410 | 81510 | 81610 |
| Eiken gelakt | | 14112 | | | | | | |
| Eiken geolied | | | | 81113 | 81213 | 81413 | 81513 | 81613 |
| Eiken wit geolied | | | | 81114 | 81214 | 81414 | 81514 | 81614 |
| Eiken gerookt naturel geolied | | | | 81115 | 81215 | 81415 | 81515 | 81615 |
| Eiken gerookt wit geolied | | | | 81116 | 81216 | 81416 | 81516 | 81616 |

7.5.2 BAMBOE PLINTEN EN AFWERKLIJSTEN

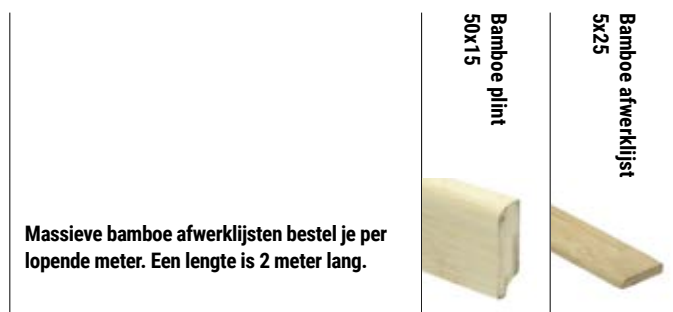

| Formaat HxB mm Lengte cm | 50x15 200 | 5x25 200 |
|-----------------------------|--------------|-------------|
| Bamboe naturel onbewerkt | 13011 | 13111 |
| Bamboe naturel gelakt | 13012 | 13112 |
| Bamboe naturel geolied | 13013 | 13113 |
| Bamboe caramel onbewerkt | 13111 | 13121 |
| Bamboe caramel gelakt | 13112 | 13122 |
| Bamboe caramel geolied | 13113 | 13123 |

7.5.3 STOFDORPELS

| Stofdorpel eiken onbehandeld | Artikelnr. |
|--|------------|
| Lengte 100 cm Dikte 22 mm | |
|  Hoogte 70 mm | 13200 |
| Hoogte 90 mm | 13201 |
| Hoogte 120 mm | 13202 |
| Hoogte 140 mm | 13203 |



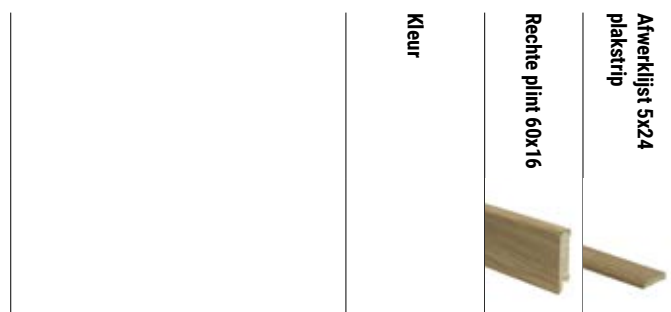

7.6 FINEER PLINTEN EN AFWERKLIJSTEN

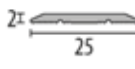

| Formaat HxB mm Lengte cm | Kleur | 60x16 240 | 5x24 240 |
|--------------------------------------|-------|--------------|-------------|
| Eiken onbehandeld | | 35109 | 33109 |
| Eiken geolied | | 35105 | 33110 |
| Eiken gelakt | | 35106 | 33111 |
| Eiken wit geolied | | 35107 | 33114 |
| Eiken wit gelakt | | 35108 | |
| Eiken Skylt-look geolied | | 35101 | 33101 |
| Eiken dekkend wit geolied | | 35102 | 33102 |
| Eiken gekalkt | | 35111 | 33113 |
| Eiken gerookt onbehandeld | | 35110 | 33107 |
| Eiken gerookt naturel geolied | | 35115 | 33115 |
| Eiken gerookt wit geolied | | 35116 | 33116 |
| Eiken dubbel gerookt naturel geolied | | 35119 | 33119 |
| Eiken dubbel gerookt wit geolied | | 35120 | 33120 |
| Eiken kerngerookt geolied | | 35185 | 33185 |
| Gestoomd beuken gelakt | | 35122 | 33122 |
| Licht beuken gelakt | | 35123 | 33123 |
| Ahorn gelakt | | 35131 | 33131 |
| Kambala gelakt | | 35162 | 33162 |
| Afzelia gelakt | | 35173 | 33173 |
| Kurk gelakt | | 35189 | 33189 |
| Kurk onbewerkt | | 35191 | 33191 |
| Wengé gelakt | | 35192 | 33192 |
| Bamboe naturel gelakt | | 35198 | 33198 |
| Bamboe caramel gelakt | | 35199 | 33199 |

7.7 PROFIELEN





7.7.1 DILATATIEPROFIELEN

| | 442 Glad breedte 25 mm | Breedte 25 mm | Breedte 30 mm | Breedte 37 mm | 441 Glad breedte 40 mm | | |
|-------------------|---|---|---|---|---|------------------------|--------------------|
| |  |  |  |  |  | | |
| Lengte cm | Zelfklevend 300 | Schroef 270 | Zelfklevend 100 300 | Zelfklevend 300 | Schroef 300 | Zelfklevend 100 300 | Zelfklevend 300 |
| Zilver | 41822 | 41116 | 41129 41115 | 41215 | 41316 | 41401 41315 | 41801 |
| Zilver geborsteld | 41821 | | 41133 41158 | 41258 | | 41408 41358 | |
| RVS | | 41156 | 41130 41155 | 41255* | 41356 | 41403 41355 | |
| RVS geborsteld | 41820 | | 41132 41157 | 41257 | | 41407 41357 | 41800 |
| Zwart | 41823 | | 41131 41165 | 41265* | | 41404 41365 | |
| Brons | | 41136 | 41134 41135* | 41235* | 41336* | 41402 41335 | 41802 |
| Goud | | | 41125* | 41225* | 41326* | 41325* | |
| Wit | | | | | | 41385 | 41803 |

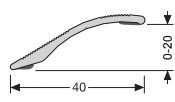

Profielen in kleur vind je in hoofdstuk 7.4 Folie plinten en profielen

* Lengte 270 cm

7.7.2 OVERGANGSPROFIELEN

| | Hoogteverschil 0-20 mm | Hoogteverschil 5 mm | Hoogteverschil 8 mm | Hoogteverschil 14 mm | Hoogteverschil 22 mm | | | |
|-------------------|---|---|---|---|---|----------------|--------------------|--------------------|
| |  |  |  |  |  | | | |
| Lengte cm | Zelfklevend 100 300 | Schroef 270 | Zelfklevend 270 | Schroef 270 | Zelfklevend 100 270 | Schroef 270 | Zelfklevend 270 | Zelfklevend 270 |
| Zilver | 50329 50359 | 51116 | 51115 | 51216 | 51201 51215 | 51316 | 51315 | 51415 |
| Zilver geborsteld | 50328 50358 | | | | | | | |
| RVS | 50331 50361 | 51156 | 51155 | 51256 | 51203 51255 | 51356 | 51355 | 51455 |
| RVS geborsteld | 50327 50357 | | | | | | | |
| Zwart | 50332 50362 | | 51165 | | 51204 51265 | | 51365 | 51465 |
| Brons | 50370 50360 | 51136 | 51135 | 51236 | 51202 51235 | 51336 | 51335 | 51435 |
| Goud | | | 51125 | | | | 51325 | 51425 |
| Wit | | | 51185 | | 51285 | | 51385 | 51485 |

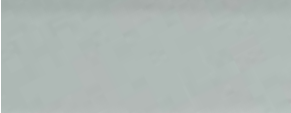
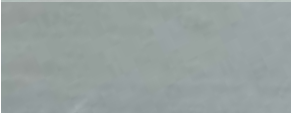
PROFIELEN KLEURENVERZICHT

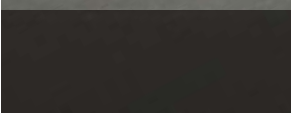
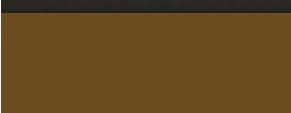
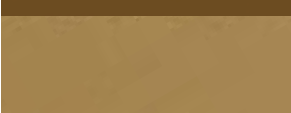
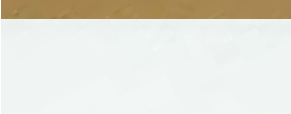
| | |
|--|-------------------|
|  | Zilver |
|  | Zilver geborsteld |
|  | RVS |
|  | RVS geborsteld |
|  | Zwart |
|  | Brons |
|  | Goud |
|  | Wit |



UNIVERSEEL OVERGANGSPROFIEL 0-20 MM



7.7.3 HOEKLIJN-, EIND- EN U-PROFIELEN

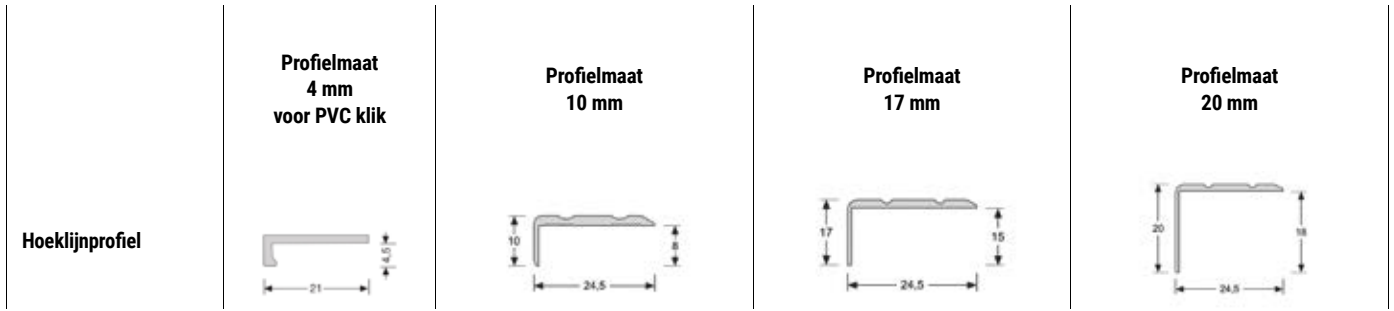

| Lengte cm | Zelfklevend | | Schroef | Zelfklevend | | Schroef | Zelfklevend | | Schroef | Zelfklevend | |
|-------------------|-------------|--------|---------|-------------|-------|---------|-------------|--------|---------|-------------|-------|
| | 250 | 300 | 300 | 100 | 300 | 270 | 100 | 300 | 300 | 100 | 300 |
| Zilver | 69515 | 69116 | | 69101 | 69115 | 69316 | 69301 | 69315 | 69216 | 69201 | 69215 |
| Zilver geborsteld | 69558** | | | 69108 | 69158 | | 69308 | 69358 | | 69208 | 69258 |
| RVS | 69555 | 69156 | | 69103 | 69155 | 69356 | 69303 | 69355 | 69256 | 69203 | 69255 |
| RVS geborsteld | 69557** | | | 69107 | 69157 | | 69307 | 69357 | | 69207 | 69257 |
| Zwart | 69565 | | | 69104 | 69165 | | 69304 | 69365 | | 69204 | 69265 |
| Brons | 69535 | 69136 | | 69102 | 69135 | 69336 | 69302 | 69335 | 69236 | 69202 | 69235 |
| Goud | | 69126* | | 69125* | 69326 | | 69325* | 69226* | | 69225* | |
| Wit | | | | 69185 | | | | | | 69285* | |

* Lengte 270 cm, ** Lengte 300 cm

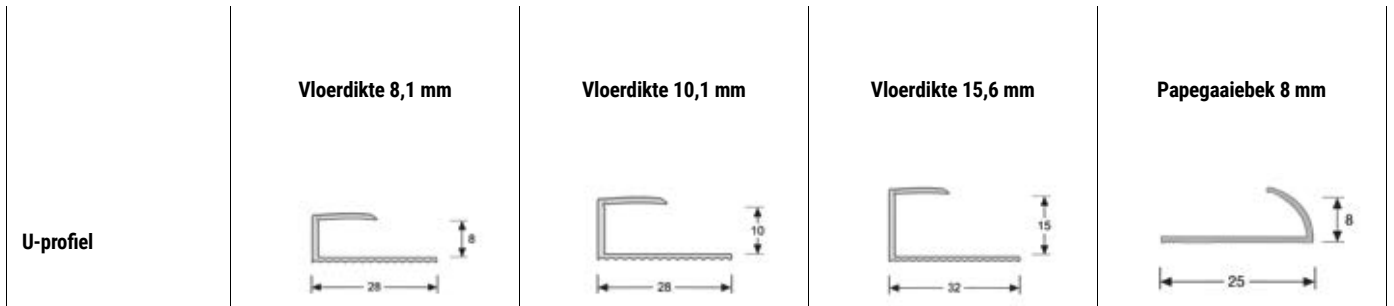

| Lengte cm | Verlijmen | | Verlijmen | | Verlijmen | | Verlijmen | |
|-----------|-----------|-------|-----------|-------|-----------|-------|-----------|-------|
| | 90 | 270 | 90 | 270 | 90 | 270 | 90 | 270 |
| Zilver | 61116 | 61115 | 61216 | 61215 | 61416 | 61415 | 66615 | 66616 |
| RVS | 61156 | 61155 | 61256 | 61255 | 61456 | 61455 | | |
| Brons | 61136 | 61135 | 61236 | 61235 | 61436 | 61435 | | |
| Goud | | 61125 | | 61225 | | 61425 | 66625 | 66626 |

Buigbare u-profielen vind je in hoofdstuk 7.7.7 Buigbare profielen

7.7.3 HOEKLIJN-, EIND EN U-PROFIELEN (vervolg)

Duo-hoeklijnprofiel

Profielmaat
24,5x30 mm

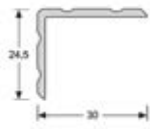





















| Lengte cm | Zelfklevend | |
|-------------------|-------------|--------|
| | 100 | 300 |
| Zilver | 69401 | 69415 |
| Zilver geborsteld | 69408 | 69458 |
| RVS | 69403 | 69455 |
| RVS geborsteld | 69407 | 69457 |
| Zwart | 69404 | 69465 |
| Brons | 69402 | 69435 |
| Goud | | 69425* |



* Lengte 270 cm





7.7.4 TRAPNEUSPROFIELEN

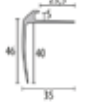



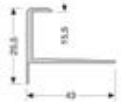



| PVC 2-3 mm | Lengte | Kleur | Artikelnr. |
|---|--------|------------------------|-------------------------|
|  | 300 cm | Zilver RVS Zwart | 65377 65378 65421 |
|  | 30 cm | Zilver | 65460 |
|  | 100 cm | Zilver | 65461 |
|  | 100 cm | Zilver | 65462 |
|  | | Zilver RVS Zwart | 65471 65472 65473 |
|  | | Zilver RVS Zwart | 65477 65478 65479 |
|  | | Zilver RVS Zwart | 65483 65484 65485 |
|  | 250 cm | Zilver RVS Brons | 65379 65380 65401 |
|  | 250 cm | Zilver RVS Brons | 65381 65382 65402 |
|  | 250 cm | Zilver RVS Brons | 65385 65386 65404 |
|  | 250 cm | Zilver RVS Brons | 65389 65390 65406 |
|  | 250 cm | Zilver RVS | 65418 65419 |
| PVC 3 mm | Lengte | Kleur | Artikelnr. |
|  | 300 cm | Zilver RVS Zwart | 65441 65440 65442 |
|  | 30 cm | Zilver | 65450 |

| PVC 3 mm | Lengte | Kleur | Artikelnr. |
|---|--------|---------------------------------|----------------------------------|
|  | 100 cm | Zilver | 65452 |
|  | 100 cm | Zilver | 65451 |
|  | 300 cm | Zilver RVS Zwart | 65416 65417 65414 |
|  | 250 cm | Zilver RVS Brons Zwart | 65316 65356 65336 65346 |
|  | 250 cm | Zilver RVS Brons | 65383 65384 65403 |
|  | 250 cm | Zilver RVS Brons | 65430 65431 65432 |

| Klik PVC | Lengte | Kleur | Artikelnr. |
|---|--------|------------------------|-------------------------|
|  | 250 cm | Zilver RVS Brons | 65800 65802 65801 |
|  | 250 cm | Zilver | 65420 |
|  | 250 cm | Zilver RVS Brons | 65387 65388 65405 |

| Duoplank, lamelparket | Lengte | Kleur | Artikelnr. |
|---|--|--|--|
|  | 250 cm | Zilver RVS Brons | 65809 65811 65810 |
|  | 135 cm 135 cm 135 cm 300 cm 300 cm 300 cm | Zilver RVS Zwart Zilver RVS Zwart | 65360 65362 65361 65357 65359 65358 |

7.7.4 TRAPNEUSPROFIELEN (vervolg)

| Laminaat | Lengte | Kleur | Artikelnr. |
|---|--|--------|---------------------|
|  | 810 trapneus 8,5 mm | 250 cm | Zilver 65803 |
| | | | RVS 65805 |
| | | | Brons 65804 |
|  | 811 trapneus 10,5 mm | 250 cm | Zilver 65806 |
| | | | RVS 65808 |
| | | | Brons 65807 |
|  | Trapprofiel 60 mm voor laminaat 7-9,5 mm | 300 cm | Zilver geb. 65312 |
| | | | RVS look geb. 65313 |
| | | | Zwart 65314 |
| Universeel | Lengte | Kleur | Artikelnr. |
|  | Trapneusprofiel | 90 cm | Zilver 66715 |
| | | | Goud 66725 |
|  | Trapneusprofiel 40x25 mm fijn antislip | 300 cm | Zilver 65368 |
| | | | RVS 65370 |
| | | | Brons 65369 |
|  | Trapneusprofiel 43x23 mm grof antislip | 300 cm | Zilver 65365 |
| | | | RVS 65366 |
| | | | Brons 65367 |
|  | Trapneusprofiel basis 31x29 mm | 300 cm | Zilver 65371 |
| | | | RVS 65372 |
| | | | Brons 65373 |
|  | Trapneusprofiel basis XL 31x43 mm | 300 cm | Zilver 65374 |
| | | | RVS 65376 |
| | | | Brons 65375 |

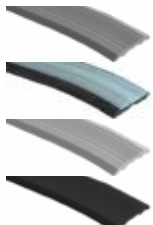
| Trapneusprofiel inleg | Lengte | Kleur | Artikelnr. |
|---|--|--------|---------------------|
|  | Trapneusprofiel Küberit zonder inleg | 250 cm | Zilver 65115 |
| | | | RVS 65155 |
| | | | Brons 65135 |
| | | | Goud 65125 |
| | | | Zand 65145 |
| Inleg voor trapneusprofiel | Lengte | Kleur | Artikelnr. |
|  | | 250 cm | Antraciet 65212 |
| | | 250 cm | Fluorescerend 65311 |
| | | 250 cm | Grijs 65313 |
| | | 250 cm | Zwart 65211 |

TRAPNEUSPROFIELEN



7.7.5 PROFIELEN VOOR PVC/LINOLEUM

| Dilatatieprofiel | Lengte | Kleur | Artikelnr. |
|---|--------------------------------------|--------|--|
|  | Aansluitprofiel 6 mm voor 2,5 mm PVC | 270 cm | Zilver 65399 RVS 65400 Brons 65412 |

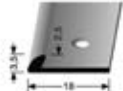
| Eindprofiel | Lengte | Kleur | Artikelnr. |
|---|------------------------------------|--------|--|
|  | Eindprofiel 3,5 mm voor 2,5 mm PVC | 250 cm | Zilver 65393 RVS 65394 Brons 65408 |

| | | | |
|---|--------------------------|--------|--------------|
|  | Eindprofiel 364 LVT 3 mm | 300 cm | Zilver 65870 |
|---|--------------------------|--------|--------------|

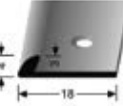
| | | | |
|---|--------------------------------|--------|--|
|  | Eindprofiel 4 mm voor 3 mm PVC | 250 cm | Zilver 65395 RVS 65396 Brons 65409 |
|---|--------------------------------|--------|--|

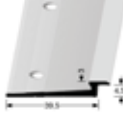
| | | | |
|---|------------------------------------|--------|---|
|  | Afsluitprofiel 346 voor 4,5 mm PVC | 300 cm | Zilver geborsteld 51781 RVS geborsteld 51780 |
|---|------------------------------------|--------|---|

| | | | |
|---|--|--------|-----------------|
|  | In-egaliseer eindprofiel voor 2,5 mm PVC | 250 cm | Gepolijst 65413 |
|---|--|--------|-----------------|

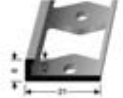
| | | | |
|---|---|--------|-----------------------------|
|  | In-egaliseer eindprofiel tot 4,5 mm PVC | 250 cm | Zilver 65397 Brons 65410 |
|---|---|--------|-----------------------------|

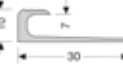
| | | | |
|---|---|--------------------------------------|--|
|  | Inschuif eindprofiel 805 7 mm voor 5 mm PVC | 100 cm 100 cm 250 cm 250 cm | Zilver 65833 RVS 65835 Zilver 65832 RVS 65834 |
|---|---|--------------------------------------|--|

| | | | |
|---|---|--------|--|
|  | Inschuif eindprofiel 8 mm voor 5 mm PVC | 250 cm | Zilver 65391 RVS 65392 Brons 65407 |
|---|---|--------|--|

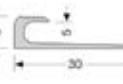
| | | | |
|---|---|--------|---------------------------|
|  | Inschuif eindprofiel 806 8 mm voor 5 mm PVC | 250 cm | Zilver 65830 RVS 65831 |
|---|---|--------|---------------------------|

| Eindprofiel | Lengte | Kleur | Artikelnr. |
|---|--------------------------------------|--------|------------|
|  | Overgangsprofiel zelfklevend 0-18 mm | 270 cm | RVS 50355 |

| | | | |
|---|---------------------------------------|--------|-----------|
|  | PVC overgangsprofiel schroef 2,5-5 mm | 270 cm | RVS 50156 |
|---|---------------------------------------|--------|-----------|

| | | | |
|---|--|--------|-----------|
|  | PVC overgangsprofiel schroef 5-7 mm Lengte 270 cm | 270 cm | RVS 50256 |
|---|--|--------|-----------|

| | | | |
|---|--------------------------------------|--------|---|
|  | Overgangsprofiel 345 voor 4,5 mm PVC | 300 cm | Zilver 51571 RVS 51570 geborsteld Zwart 51572 |
|---|--------------------------------------|--------|---|

7.7.6 KÜBERIT PROFIELEN

| Dilatatieprofiel | Dilatatieprofiel 7-15 mm | | Dilatatieprofiel 7-17 mm | | Dilatatieprofiel met kabelgoot 7-16 mm |
|------------------|--------------------------|-------|--------------------------|-------|--|
| | | | | | |
| Lengte cm | 90 | 270 | 100 | 300 | 270 |
| Zilver | 46414 | 46415 | 41514 | 41515 | 41615 |
| RVS | | | 41554 | 41555 | 41655 |
| Brons | 46434 | 46435 | 41534 | 41535 | |
| Goud | 46424 | 46425 | 41524 | 41525 | |
| Zand | | | 41544 | 41545 | |



| Eindprofiel | Eind-en afwerkprofiel 7-15 mm | | Eind-en afwerkprofiel 7-18 mm | |
|-------------|-------------------------------|-------|-------------------------------|-------|
| | | | | |
| Lengte cm | 90 | 270 | 100 | 300 |
| Zilver | 66414 | 66415 | 66214 | 66215 |
| RVS | | | 66254 | 66255 |
| Brons | 66434 | 66435 | 66234 | 66235 |
| Goud | 66424 | 66425 | | |
| Zand | | | 66244 | 66245 |



| Overgangprofiel | Overgangprofiel 7-15 mm | | Overgangprofiel 7-23 mm | | Overgangprofiel met kabelgoot 7-16 mm |
|-----------------|-------------------------|-------|-------------------------|-------|---------------------------------------|
| | | | | | |
| Lengte cm | 90 | 270 | 100 | 300 | 270 |
| Zilver | 56414 | 56415 | 51514 | 51515 | |
| RVS | | | 51554 | 51555 | 51655 |
| Brons | 56434 | 56435 | 51534 | 51535 | |
| Goud | 56424 | 56425 | 51524 | 51525 | |
| Zand | | | 51544 | 51545 | |



7.7.6 KÜBERIT PROFIELEN (vervolg)

| Dilatatieprofiel PVC | | | Eindprofiel PVC | | | Overgangsprofiel PVC | | |
|----------------------|------------------------------------|-------|-----------------|---|-------|----------------------|------------------------------------|-------|
| | Dilatatieprofiel PVC klik 4-9,5 mm | | | Eind-en afwerkprofiel PVC klik 4-9,5 mm | | | Overgangsprofiel PVC klik 4-9,5 mm | |
| | | | | | | | | |
| Lengte cm | 100 | 300 | Lengte cm | 100 | 300 | Lengte cm | 100 | 300 |
| Zilver | 41715 | 41716 | Zilver | 65956 | 65955 | Zilver | 51716 | 51715 |
| RVS | 41755 | 41756 | RVS | 65936 | 65935 | RVS | 51756 | 51755 |
| Brons | 41735 | 41736 | Brons | 65916 | 65915 | Brons | 51736 | 51735 |
| Goud | 41725 | 41726 | Goud | 65926 | 65925 | Goud | 51726 | 51725 |
| Zand | 41746 | 41745 | Zand | 65946 | 65945 | Zand | 51746 | 51745 |

| Design Clip 4-7,5 mm 578 dilatatieprofiel | | | Design Clip 4-7,5 mm 576 overgangsprofiel | | | Design Clip 4-7,5 mm 577 eindprofiel | | |
|---|-------|-------|---|-------|-------|--------------------------------------|-------|-------|
| | | | | | | | | |
| Lengte cm | 90 | 270 | 90 | 270 | 90 | 270 | 90 | 270 |
| Zilver | 65836 | 65837 | 65840 | 65841 | 65844 | 65845 | 65844 | 65845 |
| RVS | 65838 | 65839 | 65842 | 65843 | 65846 | 65847 | 65846 | 65847 |

Overig

Artikelnr.

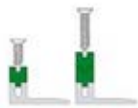

6 ophoogstukken voor Küberit dilatatie- en overgangsprofielen

41500



7.7.7 BUIGBARE PROFIELEN

BUIGBAAR U-PROFIEL



| Buigbaar U-profiel | Dikte mm | Lengte cm | Kleur | Artikelnr. |
|--------------------|----------|-----------|-------|------------|
|--------------------|----------|-----------|-------|------------|

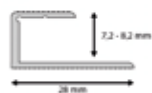

| | | | |
|-----------|-----|--------|-------|
| 7,2 - 8,2 | 270 | Zilver | 61510 |
| 9 - 10,2 | 270 | Zilver | 61520 |
| 12 - 13,2 | 270 | Zilver | 61530 |

| In-egaliseer eindprofiel | Dikte mm | Lengte cm | Kleur | Artikelnr. |
|--------------------------|----------|-----------|-------|------------|
|--------------------------|----------|-----------|-------|------------|

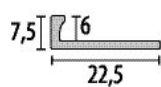

| | | | |
|---|-----|--------|-------|
| 6 | 250 | Zilver | 65398 |
| 6 | 250 | Brons | 65411 |

| Overgangsprofiel buigbaar 345 voor 4,5 mm PVC | Dikte mm | Lengte cm | Kleur | Artikelnr. |
|---|----------|-----------|-------|------------|
|---|----------|-----------|-------|------------|

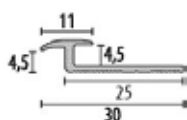

| | | | |
|-----|-----|--------|-------|
| 4,5 | 300 | Zilver | 65334 |
|-----|-----|--------|-------|

| Buigbaar trapneusprofiel voor PVC-stroken | Dikte mm | Lengte cm | Kleur | Artikelnr. |
|---|----------|-----------|-------|------------|
|---|----------|-----------|-------|------------|



| | | | |
|-----|-----|--------|-------|
| 2,5 | 250 | Zilver | 65433 |
| 2,5 | 250 | RVS | 65434 |
| 2,5 | 250 | Brons | 65435 |
| 3 | 250 | Zilver | 65315 |
| 3 | 250 | RVS | 65355 |
| 3 | 250 | Brons | 65335 |

Buigmachines

Artikelnr.

Deze machine kun je aanschaffen, maar je kunt hem ook gratis lenen: je bestelt de machine, betaalt een borgbedrag en na gebruik laat je de machine door ons weer ophalen. Zodra deze onbeschadigd en compleet retour is gekomen, krijg je jouw borg volledig terug.



Buigmachine BG1 41501
(makkelijk buigbare profielen)



Buigmachine BG2 41502
(voor buigbare trapprofielen)



Ombouwset van BG1 naar BG2 41503
buigmachine

7.8 CONVECTORPUT ROLROOSTERS



STANDAARD

17910



LUXE

17909



ALUMINIUM

17908

Standaard en luxe convectorputrolroosters zijn in de volgende uitvoeringen te bestellen:

| Houtsoort |
|--------------------|
| Eiken |
| Beuken licht |
| Beuken gestoomd |
| Essen |
| Jatoba |
| Robijn |
| Afzelia |
| Kambala Afrormosia |
| Bamboe |
| Merbau |
| Kersen |
| Ahorn |
| Mahonie Sipo |
| Walnoot |
| Wengé |
| Sucupira |

| Busjes |
|--------------------|
| Beige |
| Donkerbruine |
| Grijze |
| Dunne donkerbruine |
| Zwarte |
| Eiken |
| Merbau |
| Ahorn |
| Jatoba |
| Robijn |
| Licht beuken |
| Gestoomd beuken |
| Kambala |
| Kersen |
| Aluminium zilver |
| Aluminium messing |
| Aluminium brons |
| Aluminium zwarte |
| RVS |

| Bewerking |
|--------------------------------------|
| Onbewerkt |
| Naturel geolied |
| Wit geolied |
| Extra wit geolied |
| Grijs geolied |
| Extra grijs geolied |
| Gelakt - zijdemat |
| Gelakt - extra mat (Skylt) |
| Gerookt onbewerkt |
| Gerookt naturel geolied |
| Gerookt wit geolied |
| Gerookt grijs geolied |
| ROYL - Alaska White (10) |
| ROYL - Antiquity (23) |
| ROYL - Beach Wood (17) |
| ROYL - Black Forest (20) |
| ROYL - Blank (00) |
| ROYL - Colonial (18) |
| ROYL - Country Oak (03) |
| ROYL - Dark Oak (12) |
| ROYL - Double Smoked (14) |
| ROYL - Exotic Brown (15) |
| ROYL - Golden Oak (01) |
| ROYL - Mahogany Red (21) |
| ROYL - Mountain Grey (09) |
| ROYL - Mystic Black (08) |
| ROYL - Natural Oak (11) |
| ROYL - North Sea (22) |
| ROYL - Original Oak (30) |
| ROYL - Shell Grey (16) |
| ROYL - Smoked Oak (13) |
| ROYL - Summer Oak (02) |
| ROYL - Walnut Dark (19) |
| ROYL - B20 Pitch |
| ROYL - C10 + C10 Dubbel Alaska White |
| ROYL - C25 Antracite |
| ROYL - C28 Ocean |
| ROYL - C8 + 9 Bliss |
| ROYL - C9 + 9 Driftwood |
| ROYL - W01 Begone |
| ROYL - W09 Foggy |
| ROYL - W10 Livid |
| ROYL - W12 Secret |
| ROYL - W14 Hound |
| ROYL - W16 Overcast |
| ROYL - W17 Grasping |
| ROYL - W19 Ruthless |
| ROYL - W20 Grumbling |
| ROYL - W22 Sooty |
| ROYL - W23 Rivet |
| ROYL - W26 Taupe |
| ROYL - W27 Summer Beach |

| Materiaal |
|--------------------------------|
| Aluminium blank - hoogte 15 mm |
| Aluminium blank - hoogte 20 mm |
| Aluminium blank - hoogte 25 mm |
| Aluminium brons - hoogte 15 mm |
| Aluminium brons - hoogte 20 mm |
| Aluminium brons - hoogte 25 mm |
| Aluminium zwart - hoogte 15 mm |
| Aluminium zwart - hoogte 20 mm |
| Aluminium zwart - hoogte 25 mm |

| Busjes |
|-------------------|
| Aluminium blank |
| Aluminium brons |
| Aluminium zwart |
| Aluminium messing |
| PVC grijs |
| PVC zwart |
| PVC beige |
| PVC bruin dun |
| PVC bruin |

Wij leveren drie soorten convectorput rolroosters: standaard, luxe en aluminium.

De convectorputrolroosters zijn via een speciale tool te bestellen op onze webshop, of neem contact op met de verkoopbinnendienst via 0343 432 321.

Scan de QR-code of ga naar onze webshop



SCAN DE QR-CODE

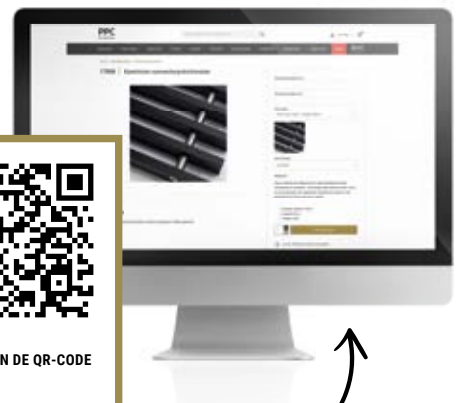

Eenvoudig samen te stellen
op onze webshop

Ophoogrubber met plakstrip Artikelnr.





Ophoogrubber met plakstrip 25 mm breed

| | |
|------------|-------|
| Dikte 1 mm | 17930 |
|------------|-------|

| | |
|------------|-------|
| Dikte 3 mm | 17931 |
|------------|-------|



| | |
|------------|-------|
| Dikte 5 mm | 17932 |
|------------|-------|

7.9 PVC BIEZEN

| PVC biezen | Lengte | Kleur | Artikelnr. |
|---|--------|-------|------------|
|  | 100 cm | Zwart | 89290 |
| | | Grijs | 89291 |
| | | Bruin | 89292 |
|  | 100 cm | Zwart | 89293 |

7.10 LUIKPROFIELEN EN -RINGEN

| Luikprofiel | Lengte | Kleur | Artikelnr. |
|---|--------|--------|------------|
|  | 250 cm | Zilver | 71316 |
| | | RVS | 71318 |
| | | Zwart | 71319 |

| Luikring | Kleur | Artikelnr. |
|--|-------|------------|
|  | RVS | 71312 |
| | Bronz | 71310 |
|  | | |

7.11 DEURSTOPPERS

| Deurstoppers | Kleur | Artikelnr. |
|---|-------------|------------|
|  | RVS | 82197 |
| | RVS | 82198 |
|  | Transparant | 82205 |
| | Zwart | 82208 |
|  | Transparant | 82199 |
|  | Transparant | 82200 |
|  | Transparant | 82201 |

7.12 HANDWAAIERS, FOLDERS EN DISPLAYS

| Presentatiemateriaal | Artikelnr. |
|--|------------|
|  Display voor Sfeerplinten Inclusief de samples die op de afbeelding te zien zijn. Exclusief folders (16006) | 99996 |
|  Plintenpaal Onze nieuwe plintenpaal. In wit en strak design. Een aanwinst voor in je winkel! Let op: De plintenpaal wordt geleverd zonder PPC monsterpakket (99999) | 99998 |
|  PPC monsterpakket Direct het meest uitgebreide pakket randafwerking beschikbaar! | 99999 |
|  Sfeerplinten handwaaier RAL-kleuren | 16005 |
|  Monsterwaaier MDF Sfeerplinten | 99945 |
|  Sfeerplinten hoekstukkenwaaier | 16390 |
|  SfeerPlinten folders (25 stuks) | 16006 |
|  Monsterwaaier wit gefoliede plinten | 99956 |
|  Monsterwaaier Meranti plinten en koplatten | 99912 |
|  Handwaaier Döllken Cubu plinten | 20167 |
|  Modellenwaaier decorfolie | 99918 |
|  Monsterwaaier modellen massief hout | 99943 |

7.12 HANDWAAIERS, FOLDERS EN DISPLAYS

| Presentatiemateriaal | Artikelnr. |
|---|--|
|  | Monsterwaaier houtsoorten massief hout 99911 |
|  | Monsterwaaier massieve bamboe plinten & afwerklijsten 99955 |
|  | Monsterwaaier gekleurde eiken plinten 99916 |
|  | Monsterbord complete vloerafwerking 99941 |
|  | PPC folie randafwerking 175 kleuren 2 bundels 99973 |
|  | PPC basis profielenwaaier 99922 |
|  | PPC basis profielen presentatiebord 99986 |
|  | Display Vloer-Profielen 99980 |
|  | Vloer-Profielen folder (25 stuks) 99906 |
|  | Monsterwaaier PVC profielen 99937 |

| Presentatiemateriaal | Artikelnr. |
|---|---|
|  | Monsterwaaier trapneusprofielen 99942 |
|  | Monsterkoffer Küberit profielen (uitgebreid) 99959 |
|  | Monsterwaaier professionele Küberit profielen 99932 |
|  | Monster aluminium convectorputrolrooster zwart 99947 |
|  | Monster convectorput rolrooster 99948 |
|  | Monster luxe convectorput rolrooster 99950 |

SAMPLE SERVICE

Kijk in onze webshop voor onze sfeerplinten sample service. Scan de QR-code!

Of ga naar:
Randafwerking > Promotiemateriaal > Samples

BESTEL JE SAMPLES



SCAN DE QR-CODE

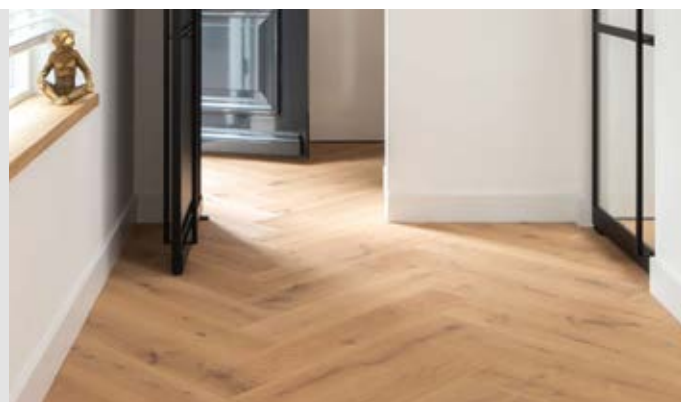









8. ONDERHOUD



| | | |
|------------|---------------------------|------------|
| 8.1 | ONDERHOUDSMIDDELEN | 138 |
| 8.1.1 | BONA | 138 |
| 8.1.2 | BLANCHON | 138 |
| 8.1.3 | DR. SCHUTZ | 139 |
| 8.1.4 | FLOORSERVICE | 140 |
| 8.1.5 | FRIS | 140 |
| 8.1.6 | KERAKOLL | 140 |
| 8.1.7 | LECOL | 140 |
| 8.1.8 | QUICK•STEP | 141 |
| 8.1.9 | ROYL | 141 |
| 8.1.10 | SKYLT | 141 |
| 8.1.11 | STEP | 142 |
| 8.1.12 | WOCA | 142 |
| 8.1.13 | PRODUCTEN VOOR BUITEN | 143 |
| 8.2 | VLOERWISSERS | 143 |
| 8.2.1 | BONA | 143 |
| 8.2.2 | QUICK•STEP | 144 |
| 8.2.3 | WOCA | 144 |
| 8.2.4 | OVERIG | 144 |
| 8.3 | VLOERBESCHERMING | 145 |
| 8.3.1 | KRASBESCHERMING | 145 |
| 8.3.2 | BUREAUSTOELMATTEN | 146 |
| 8.3.3 | AFDEKMATERIALEN | 146 |
| 8.3.4 | PARKETENTREE MATTEN | 147 |
| 8.4 | REPARATIE | 148 |
| 8.5 | LUCHTBEVOCHTIGING | 149 |
| 8.5.1 | HYGROMETERS | 149 |
| 8.5.2 | LUCHTBEVOCHTIGERS | 149 |
| 8.5.3 | LUCHTONTVOCHTIGERS | 150 |
| 8.5.4 | ACCESSOIRES | 150 |



8.1 ONDERHOUDSMIDDELEN



8.1.1 BONA

| Hout onderhoud | Inhoud | Artikelnr. |
|--|--------|------------|
|  Gelakte houten vloer refresher 1 liter per 70 m ² | 1 l | 96127 |
|  Houten vloerreiniger 1 liter per 250 m ² | 1 l | 96124 |



| Lak onderhoud | Kleur | Inhoud | Artikelnr. |
|---|-------|--------|------------|
|  D-509 parket polish 1 liter per 80 m ² | | 1 l | 96720 |
|  Fernox parket ontvetter 50-100 ml per 10 liter warm water | | 1 l | 96721 |
|  Polish glans 1 liter per 80 m ² | Glans | 1 l | 96725 |
| | Mat | 1 l | 96724 |
|  Cleaner 50-100 ml per 10 liter warm water | | 1 l | 96726 |
|  Polish Remover 1 liter per 5 liter warm water | | 1 l | 96727 |
|  Freshen Up 1 liter per 60-70 m ² | | 1 l | 96728 |



| Olie onderhoud | Kleur | Inhoud | Artikelnr. |
|---|---------|------------|----------------|
|  Oil Soap 200 ml per 10 liter warm water | | 1 l 5 l | 96181 96182 |
|  Oil Care W 1 liter per 40 m ² | Naturel | 1 l 5 l | 96172 96173 |
| | Grijs | 1 l | 96184 |
|  Bona Wax Oil W 1 liter per 50-80 m ² | | 1 l | 96128 |

| Laminaat en PVC onderhoud | Inhoud | Artikelnr. |
|---|--------|------------|
|  Tegel- en laminaatpolish 1 liter per 70 m ² | 1 l | 96133 |
|  Tegel- en laminaatreiniger 1 liter per 250 m ² | 1 l | 96135 |

| Powerscrubben | Inhoud | Artikelnr. |
|--|--------|------------|
|  Deep Clean Solution 1 liter per 9 liter water voor powerscrubben | 5 l | 96729 |
|  Bona Power Scrubber 2.0 | | 95378 |

8.1.2 BLANCHON



| Laminaat en PVC onderhoud | Inhoud | Artikelnr. |
|---|--------|------------|
|  Cleaner Lisabril 1 liter per 500 m ² | 1 l | 90103 |
|  Polish remover 1 liter per 250 m ² | 1 l | 90162 |

| Olie onderhoud | Kleur | Inhoud | Artikelnr. |
|---|-------------|------------|----------------|
|  Natuurlijke zeep 50 ml per 5 liter warm water | Transparant | 1 l 5 l | 90151 90152 |
| | Wit | 1 l 5 l | |
|  Powerful cleaner 1 liter per 250 m ² | | 1 l | 90166 |

| Universeel | Inhoud | Artikelnr. |
|---|--------|------------|
|  Cleaner Lisabril 1 liter per 400 m ² | 500 ml | 90146 |

8.1.3 DR. SCHUTZ

| Sets | Inhoud | Artikelnr. |
|---|---|-------------|
|  | Starterskit PVC vloeren PU reiniger, basisreiniger R, elatex reiniger, vlekenspray R, vlek en weg reiniger, melamine sponsje, vlekkenwijzer, promotiekit voor niet krassende doppen Scratchnomore | 1 set 91501 |
|  | Onderhoudset geolied hout- en kurkvloer 2x houtzeep 750 ml, 1x H2Olie, padmeester doodle bug met groene pad | 1 set 91531 |
|  | Design PVC vloeren onderhoudsset PU reiniger 750ml, witte handpad | 1 set 91516 |
|  | Scratchfix PU reparatiespray, PU reparatiepen | 1 set 91508 |

| Laminaat onderhoud | Inhoud | Artikelnr. |
|---|--|--------------|
|  | Laminaatreiniger 10 ml per 10 m ² | 750 ml 91507 |
|  | Laminaat reiniger 50-100 ml per 10 liter water | 5 l 91535 |

| PVC onderhoud | Inhoud | Artikelnr. |
|---|---|---------------------------|
|  | PU reiniger 10 ml per 10 m ² | 750 ml 91502 5 l 91510 |
|  | Basisreiniger R 1 liter per 20 m ² | 750 ml 91503 5 l 91509 |
|  | Dr. Schutz actief reiniger R280 1 liter per 20 m ² | 750 ml 91514 5 l 91538 |
|  | Vinyl Polish supermat 1 liter per 40 m ² | 750 ml 91472 5 l 91473 |
|  | R1000 cleaner 2-3 liter per 100 m ² | 750 ml 91511 5 l 91512 |
|  | Elatex reiniger | 200 ml 91504 |
|  | Vlekenspray R reiniger | 200 ml 91505 |

CREËER JE EIGEN PRIVATE LABEL ONDERHOUD

Onderhoudsartikelen afgestemd op jouw huisstijl, PPC maakt het mogelijk!
Wij ontwerpen voor jou een unieke signing, printen deze en voorzien de producten van dit gepersonaliseerde etiket. Resultaat, een krachtige en herkenbare presentatie van je eigen onderhoudsproducten!







SCAN DE QR-CODE

Scan voor meer informatie

AL VANAF 1 DOOS TE BESTELLEN!



| Hout onderhoud | Kleur | Inhoud | Artikelnr. |
|---|---------|-----------------------------|------------|
|  | | 750 ml | 91519 |
| | | 5 l per 10 liter water | 91520 |
|  | Mat | 750 ml | 91523 |
| | | 5 l | 91524 |
| | Glans | 750 ml | 91521 |
| | | 5 l | 91522 |
|  | | 750 ml | 91525 |
| | | 5 l per 7-10 m ² | 91526 |
|  | Naturel | 750 ml | 91532 |
| | | 5 l | 91533 |
| | Wit | 750 ml | 91534 |
| | | | |

| Overig | Inhoud | Artikelnr. |
|---|-------------------------------|--------------|
|  | Vlek en weg reiniger | 100 ml 91506 |
|  | Vlek en weg | 400 ml 91518 |
|  | Spraymax | 1 l 91536 |
|  | Premium onderhoudsolie | 1 l 91527 |

8.1.4 FLOORSERVICE



| Olie onderhoud | Kleur | Inhoud | Artikelnr. |
|---|------------|--------|------------|
|  | Naturel | 1 l | 97885 |
| | Wit | 1 l | 97886 |
| | Antiek wit | 1 l | 97884 |

TIP!

Gebruik een Floorboy om de onderhoudsolie gemakkelijk te verwerken. Deze zijn te vinden in hoofdstuk 9: Gereedschap of kijk in onze webshop.

| Lak onderhoud | Kleur | Inhoud | Artikelnr. |
|---|-------|------------------------------------|------------|
|  | | 1 l | 97887 |
| | | 100-200 ml per 10 liter warm water | |
|  | Satin | 1 l | 97888 |
| | Mat | 1 l | 97889 |
|  | | 1 l | 97890 |
|  | | 1 l | 97897 |

8.1.5 FRIS





| FRIS laminaat en PVC onderhoud | Inhoud | Artikelnr. |
|---|-------------------|------------|
|  | 1 l | 82747 |
| Laminaatreiniger | 50 ml per 5 liter | |
|  | 1 l | 82748 |
| PVC- en vinylreiniger | 50 ml per 5 liter | |

8.1.6 KERAKOLL







| Lak onderhoud | Inhoud | Artikelnr. |
|---|-------------------------|------------|
|  | 1,5 l | 96694 |
| SLC Supersoap reiniger | 50 ml per 3 liter water | |

8.1.7 LECOL



| Olie en was onderhoud | Kleur | Inhoud | Artikelnr. |
|---|---------|---|------------|
|  | | 1 l | 77120 |
| OH-22 Oil Care | | 1 liter per 30-100 m ² | |
|  | Naturel | 1 l | 77121 |
| | Wit | 1 l | 77122 |
| OH-23 Soap | | 50-100 ml op 10 liter water voor 100 m ² | |
|  | Naturel | 1 l | 77031 |
| | Wit | 1 l | 77032 |
| OH-25 Conditioner | | 1 liter per 100 m ² | |
|  | | 1 l | 77123 |
| OH-27 Intense cleaner | | 1 liter op 2-10 liter water voor 100 m ² | |
|  | | 1 l | 77033 |
| | | 200-300 ml op 10 liter water per 100 m ² | |
| OH-32 Was & Clean | | | |
|  | | 1 l | 77034 |
| | | 1 liter per 25-50 m ² | |
| OH-34 Wax Remover | | | |
|  | Wit | 1 l | 77051 |
| | Geel | 1 l | 77048 |
| Vloeibare was | | 1 liter per 80 m ² | |
|  | | 1 l | 77035 |
| OH-36 Step-Stop | | 1 liter per 50-100 m ² | |
|  | | 1 l | 77124 |
| | | 1 liter per 50-100 m ² | |
| OH-39 Wax Care | | | |

| Lak onderhoud | Kleur | Inhoud | Artikelnr. |
|---|-----------|----------------------------------|------------|
|  | Zijdemat | 1 l | 77037 |
| | Extra mat | 1 l | 77038 |
| OH-41 Easy Polish | | 1 liter per 35 m ² | |
|  | Glans | 1 l | 77045 |
| | Mat | 1 l | 77046 |
| V-6 Master Polish | | 1 liter per 30-35 m ² | |
|  | | 1 l | 77040 |
| Anti-Slip Polish | | 1 liter per 100 m ² | |
|  | | 1 l | 77126 |
| OH-43 Care Cleaner invisible | | 1 liter per 100 m ² | |







8.1.7 LECOL (vervolg)

| Universeel onderhoud | | Inhoud | Artikelnr. |
|---|--|--------|------------|
|  | OH-45 Remover 100-200 ml op 10 liter water per 100 m ² | 1 l | 77039 |
|  | OH-49 Clean 50-100 ml op 10 liter water per 100 m ² | 1 l | 77041 |
| Laminaat onderhoud | | Inhoud | Artikelnr. |
|  | OH-70 Refresher 100-500 ml op 10 liter water per 100 m ² | 1 l | 77042 |
| PVC onderhoud | | Inhoud | Artikelnr. |
|  | OH-51 PVC Polish 1 liter per 30-35 m ² | 1 l | 77043 |
|  | OH-59 PVC Cleaner 50-100 ml op 10 liter water per 100 m ² | 1 l | 77044 |
|  | OH-55 PVC Remover 1 liter op 4 tot 10 liter water voor 100 m ² | 1 l | 77125 |



8.1.8 QUICK-STEP

| Quick-Step laminaat, PVC en parket onderhoud | Kleur | Inhoud | Artikelnr. |
|---|---------|--------|------------|
|  | | 1 l | 07555 |
| | | 2,5 l | 07556 |
|  | | 1 l | 07557 |
|  | Naturel | 1 l | 07535 |
| | Wit | 1 l | 07537 |





8.1.9 ROYL

| Olie en was onderhoud | | Kleur | Inhoud | Artikelnr. |
|--|---|--|-------------------|-------------------------|
|  | Milde reiniger #9110 50 ml per 5 liter warm water | | 1 l 5 l | 98449 98450 |
|  | Intensief reiniger #9120 200 ml per 5 liter warm water | | 1 l 5 l | 98447 98448 |
|  | Vloerzeep 50 ml per 5 liter warm water | Naturel #9130 Wit #9131 | 1 l 1 l | 98455 98456 |
|  | Onderhoudsolie 1 liter per 60-100 m ² | Naturel #9090 Watergedragen #9080 Wit #9091 | 1 l 1 l 1 l | 98451 98452 98453 |
|  | Project onderhoud 2K #4580 1 liter per 100-150 m ² | | 1 l | 98454 |
|  | Onderhoudsset in cadeauverpakking Milde reiniger, 0,25 l | | 1 set | 98903 |

8.1.10 SKYLT

| Lak onderhoud | Inhoud | Artikelnr. | |
|---|--|------------|----------------|
|  | Conditioner #9140 100-200 ml op 5 à 6 liter water | 1 l 5 l | 98958 98910 |
| | Conditioner spray #9141 1 liter per 20-100 m ² | 500 ml | 98957 |
|  | Onderhoudsset in cadeauverpakking Milde reiniger, 0,25 l | 1 set | 98955 |

8.1.11 STEP







| Lak onderhoud | Kleur | Inhoud | Artikelnr. |
|---|-------|--------|------------|
|  Milde parketlak reiniger #9160 50 ml per 5 liter warm water | | 1 l | 98587 |
|  Floor polish 1 liter per 40-50 m ² | Gloss | 1 l | 98949 |
| | Satin | 1 l | 98950 |
| | Mat | 1 l | 98952 |
|  Intensieve reiniger 0,5-1 liter per 5 liter warm water | | 1 l | 98956 |
|  Onderhoudsset in cadeauverpakking | | 1 set | 98586 |



TIP!



Download de onderhoudswijzer voor Rigostep lak in onze webshop.

8.1.12 WOCA

| Olie onderhoud | Kleur | Inhoud | Artikelnr. | |
|--|-----------|-----------|------------|-------|
|  Zeep 125 ml per 5 liter warm water | Naturel | 1 l | 97211 | |
| | | 2,5 l | 97212 | |
| | | 5 l | 97213 | |
| | Wit | 1 l | 97214 | |
| | | 2,5 l | 97215 | |
| | | 5 l | 97216 | |
| | Extra wit | 2,5 l | 97221 | |
| | | Grijs | 1 l | 97198 |
| | | Zwart | 2,5 l | 97199 |
| | | 3 l | 97200 | |
|  Zeep spray 1 liter per 150-200 m ² | Naturel | 750 ml | 97209 | |
| | Wit | 750 ml | 97210 | |
|  Intensiefreiniger 125 ml per 5 liter warm water | | 1 l | 97217 | |
| | | 2,5 l | 97218 | |
|  Intensiefreiniger sprayflacon | | 750 ml | 97230 | |
|  Onderhoudsolie 1 liter per 30-40 m ² | Naturel | 1 l | 97219 | |
| | | 2,5 l | 97220 | |
| | | 1 l | 97222 | |
| | Wit | 2,5 l | 97223 | |
| | | Extra wit | 1 l | 97245 |
| | | Grijs | 1 l | 97242 |
| | Bruin | 1 l | 97243 | |
|  Olieconditioner 1 liter per 150-200 m ² | Naturel | 250 ml | 97233 | |
| | | 1 l | 97234 | |
| | | 2,5 l | 97235 | |
| | Wit | 250 ml | 97236 | |
| | | 1 l | 97237 | |
| | | 2,5 l | 97238 | |

| Olie onderhoud | Kleur | Inhoud | Artikelnr. |
|--|-----------|--------|------------|
|  Olieconditioner spray | Naturel | 750 ml | 97227 |
| | Wit | 750 ml | 97228 |
|  Onderhoudsgel 200 ml per 20-30 m ² | Naturel | 200 ml | 97383 |
| | Extra wit | 200 ml | 97385 |
|  Maintenance box Onderhoudsolie 1 liter, zeep 1 liter, intensiefreiniger 1 liter, katoenen doek, witte pad 8 x 14 cm + padhouder en een sproeikop | Naturel | 1 set | 97240 |
| | Wit | 1 set | 97241 |
|  Masterzeep Commercial Naturel 1 liter per 320-400 m ² | | 5 l | 97208 |
|  Invisible Oil Care 1 liter per 6-12 m ² | | 1 l | 97382 |
|  Oil Care 1 liter per 30-40 m ² | Naturel | 200 ml | 97083 |
| | Wit | 200 ml | 97084 |
|  Superontvlekker | | 250 ml | 97231 |
|  Easy neutralizer spray | | 250 ml | 97239 |

| Olie onderhoud | Inhoud | Artikelnr. |
|---|--------|------------|
|  Superontvlekker | 250 ml | 97231 |
|  Easy Neutralizer Spray | 250 ml | 97239 |

| Lak en vinyl onderhoud | Kleur | Inhoud | Artikelnr. |
|---|----------|--------|------------|
|  Master Care 1 liter per 60 m ² | Naturel | 1 l | 97147 |
| | Ultramat | 1 l | 97148 |
|  Master Cleaner 1 liter per 400 m ² | | 1 l | 97149 |

8.1.12 WOCA (vervolg)

| Floorwasher | Kleur | Artikelnr. |
|---|-------|------------|
|  Floorwasher F35 inclusief borstel | | 97346 |
|  Borstelset Floorwasher F35 | Grijs | 97348 |
|  Borstelset Floorwasher F35 | Zwart | 97347 |

8.1.13 PRODUCTEN VOOR BUITEN











| Producten voor buiten | Inhoud | Artikelnr. |
|--|--------------|----------------|
|  Exterior Cleaner 1 liter per 10-50 m ² | 1 l 2,5 l | 97453 97426 |
|  Houtontgrijzer spray 1 liter per 5-15 m ² | 750 ml | 97229 |
|  Hout ontgrijzer 1 liter per 8-10 m ² | 2,5 l 5 l | 97429 97430 |
|  Schrobborstel 16" wit/groen | 1 stuk | 97911 |
|  Universele terrasschrobber 16" | 1 stuk | 97400 |
|  Terrasschrobber met steel | 1 stuk | 97399 |
|  Terrasschrobber | 1 stuk | 97315 |
|  Bezemsteel 170 cm (Ø 2,8 cm) | 1 stuk | 92194 |

TIP!

Meer gereedschappen zijn te vinden in hoofdstuk 9: Gereedschap of kijk in onze webshop.

8.2 VLOERWISSERS



8.2.1 BONA

| Houten vloer | Inhoud | Artikelnr. |
|---|---------|------------|
|  Premium spraymopset gelakte houten vloeren Premium spray pop voor houten vloeren, houten vloerreiniger (850 ml), microfiber cleaning pad | 1 stuk | 96146 |
|  Premium gelakte houten vloeren spraynavulling 1 liter per 250 m ² | 850 ml | 96147 |
|  Navulling gelakte houten vloerreiniger 1 liter per 250 m ² | 4 l | 96125 |
|  Premium spraymopset geolieide houten vloeren Premium spray pop voor deolieide houten vloeren, geolieide houten vloerreiniger (850 ml), microfiber cleaning pad | 1 stuk | 96150 |
|  Premium geolieide houten vloeren spraynavulling 1 liter per 150 m ² | 850 ml | 96151 |
|  Navulling geolieide houten vloer reiniger 1 liter per 250 m ² | 2,5 l | 96144 |
|  Houten vloer startpakket 4-delige mop met draaibare voet, microfiber cleaning pad, houten vloerreiniger (1 liter sprayfles) | 1 stuk | 96123 |
| Laminaat en PVC onderhoud | | |
|  Premium spraymopset laminaat Premium spray mop voor harde vloeren, tegel- en laminaatreiniger (850 ml), microfiber cleaning pad | 1 set | 96148 |
|  Premium laminaat spraynavulling 1 liter per 150 m ² | 850 ml | 96149 |
|  Navulling voor laminaatreiniger 1 liter per 250 m ² | 4 liter | 96136 |
|  Tegel- en laminaat startpakket 4-delige mop met draaibare voet, microfiber cleaning pad, tegel- en laminaatreiniger (1 liter sprayfles) | 1 set | 96138 |

8.2.1 BONA (vervolg)

| Vloerwissers | | Artikelnr. |
|---|--------------------------------|------------|
|  | Vloermop met verstelbare stang | 96132 |
|  | Reinigingspad | 96129 |
|  | Stofpad (elektrostatisch) | 96130 |
|  | Pad voor refresher | 96131 |



8.2.2 QUICK-STEP

| Vloermop | | Artikelnr. |
|---|-------------|------------|
|  | Spraymopset | 07554 |
|  | Spraymop | 07553 |

8.2.3 WOCA





| Vloermop | | Artikelnr. |
|--|--------------------------------|------------|
|  | Spraymop | 97316 |
|  | Spraymop vervangende mop | 97317 |
|  | Blauwe mop | 97349 |
|  | Vervangingsmop voor blauwe mop | 97350 |
|  | Sweepmop | 97351 |
|  | Vervangingsmop | 97352 |

8.2.4 OVERIG





| Vloerwissers | Kleur | Maat | Artikelnr. |
|---|--------------------------------|----------------|------------|
|  | Aluminium telescoopsteel | 100-160 cm | 97147 |
| | | | 97148 |
|  | Vloerwisser bodemplaat | Blauw | 97149 |
|  | Microvezel vlakmopdoek 5 stuks | Blauw 40-42 cm | 97149 |

8.3 VLOERBESCHERMING

8.3.1 KRASBESCHERMING

| Vast vilt | Aantal | Afmeting | Artikelnr. | | |
|---|---|-----------------------|------------|----------|-------|
|  | Viltglijder met schroef | 1 stuk | 18 mm | 94113 | |
| | | 100 stuks | 20 mm | 94114 | |
| | | 100 stuks | 24 mm | 94115 | |
| | | 100 stuks | 28 mm | 94116 | |
| | | 1 stuk | 30 mm | 94117 | |
| | | 1 stuk | 35 mm | 94118 | |
|  | Gluefelt plakvilt | 1 stuk | 20 mm | 94134 | |
| | | 1 stuk | 25 mm | 94135 | |
| | | 1 stuk | 30 mm | 94136 | |
|  | Viltglijder voor ronde holle poten | 1 stuk | 11-12 mm | 93900 | |
| | | 1 stuk | 12-14 mm | 93901 | |
| | | 1 stuk | 15-16 mm | 93902 | |
| | | 1 stuk | 16-17 mm | 93903 | |
| | | 1 stuk | 17-18 mm | 93904 | |
| | | 1 stuk | 19-20 mm | 93905 | |
| | | 1 stuk | 21-23 mm | 93906 | |
| | | 1 stuk | 25-27 mm | 93907 | |
| | | 1 stuk | 27-28 mm | 93908 | |
| | | 1 stuk | 34-35 mm | 93910 | |
| |  | Viltstrip zelfklevend | 1 stuk | 3 mm x | 94119 |
| | | | 50 stuks | 100x5 cm | 94120 |

| Vervangbare viltglijders | Afmeting | Artikelnr. | | |
|---|--------------------------|------------|-------|-------|
|  | Vervangbare viltglijders | 1 stuk | 17 mm | 94020 |
| | | 1 stuk | 20 mm | 94021 |
| | | 1 stuk | 25 mm | 94022 |
| | | 1 stuk | 30 mm | 94023 |

| Scratch no More | Aantal | Afmeting | Artikelnr. | |
|---|---|-------------------------------|------------|----------|
|  | Footfixx Hollow | | | |
| | Small 10-15 mm | 1 stuk | 28 mm | 93694 |
| | | 4 stuks | 28 mm | 93756 |
| | | 1 stuk | 34 mm | 93697 |
| | Medium 14-21 mm | 1 stuk | 28 mm | 93695 |
| | | 4 stuks | 28 mm | 93757 |
| | | 1 stuk | 34 mm | 93698 |
| | Large 20-30 mm | 1 stuk | 28 mm | 93696 |
| | | 1 stuk | 34 mm | 93699 |
| | | 4 stuks | 34 mm | 93758 |
| |  | Footfixx Hollow los basisdeel | | |
| | | Small | 1 stuk | 10-15 mm |
| Medium | | 1 stuk | 14-21 mm | 93701 |
|  | Footfixx schroefdraad | | | |
| | M6 met voetje | | 28 mm | 93719 |
| | M8 | | 28 mm | 93703 |
| | | | 34 mm | 93704 |
| | | los basisdeel | 93705 | |
|  | Footfixx los beschermvoetje | | 28 mm | 93715 |
| | | | 34 mm | 93716 |

| Scratch no More | Aantal | Afmeting | Artikelnr. | | |
|---|-------------------------------------|----------|-----------------|-------|-------|
|  | Footfixx Wood basisdeel met schroef | | 93710 | | |
| | | | | | |
|  | Footfixx Wood Medium | 1 stuk | 28 mm | 93711 | |
| | | 4 stuks | 28 mm | 93759 | |
| | Large | 1 stuk | 34 mm | 93712 | |
| | | 4 stuks | 34 mm | 93760 | |
|  | Footclick 2 | 4 stuks | 25 mm | 93720 | |
| | | 4 stuks | 31 mm | 93721 | |
| | | 1 stuk | 44 mm | 93722 | |
|  | Footclick 2 Blister | S | 4 stuks | 25 mm | 93761 |
| | | M | 4 stuks | 31 mm | 93762 |
| | | L | 4 stuks | 44 mm | 93763 |
|  | Multifixx | 1 stuk | 50 x 26 mm | 93730 | |
| | | 4 stuks | 50 x 26 mm | 93766 | |
|  | Minifixx | 1 stuk | 35 x 18 mm | 93718 | |
| | | 4 stuks | 35 x 18 mm | 93767 | |
|  | Chairfixx met verwijderbare pin | 1 stuk | 12 mm | 93731 | |
| | | 4 stuks | 12 mm | 93764 | |
| | | 1 stuk | 14 mm | 93724 | |
| | | 1 stuk | 16 mm | 93735 | |
| | | 1 stuk | 19 mm | 93736 | |
| | | 1 stuk | 22 mm | 93737 | |
| | | 1 stuk | 25 mm | 93738 | |
| | | 4 stuks | 25 mm | 93765 | |
|  | Threadfixx M6 | 1 stuk | 34 mm | 93723 | |
| | | | | | |
|  | Zwenkwiel | | 40 mm | 93728 | |
| | | | 65 mm | 93750 | |
|  | Stift voor zwenkwiel | | 65 mm 10x20/10 | 93751 | |
| | | | 65 mm 11x20/10 | 93752 | |
|  | Stift/schroef voor zwenkwiel | | 65 mm M8x15/10 | 93753 | |
| | | | 65 mm M10x15/10 | 93754 | |
| | | | 65 mm M10x25/10 | 93755 | |
|  | Vilt onderhoudsborstel | | 93739 | | |

8.3.1 KRASBESCHERMING (vervolg)

| Scratch no More promotiemateriaal | Artikelnr. |
|---|---|
|  | Presentatiedisplay 93768 |
|  | Monsterkoffer 93727 |
|  | Displaydoos Footclick 2 93725 15 x 4 Footclick 2 ø25mm en 15 x 4 ø31mm |
|  | Displaydoos Footfixx Wood 93726 15 x 4 Footclick 2 ø25mm en 15 x 4 ø31mm |
|  | Scratch no More folder 93769 75 stuks |

| Overige bescherming | Afmeting | Artikelnr. |
|---|------------------------------|------------|
|  | Beschermcup voor wiel | |
| | 15 mm | 94245 |
| | 23 mm | 94246 |
| | 30 mm | 94247 |
| | 40 mm | 94249 |
| | 50 mm | 94250 |
|  | Zwenkwiel | |
| | 50 mm stift 10 mm | 94100 |
| | 50 mm stift 11 mm | 94101 |
|  | Stift voor zwenkwiel | |
| | 50 mm 10 mm | 93915 |
| | 50 mm 11 mm | 93916 |

8.3.2 BUREAUSTOELMATTEN

| | Afmeting | Artikelnr. |
|--|-----------------------------------|------------|
|  | Parketsaver bureaustoelmat | |
| | 1,20x0,91 m | 94211 |
| | 1,20x1,50 m | 94212 |





8.3.3 AFDEKMATERIALEN

| | Inhoud/afmeting | Artikelnr. |
|---|---|------------|
|  | PPC A-Kwaliteit Stucloper wit 50 m ² 100 - 130 cm breed | 92358 |
|  | PPC zelfklevend afdekvlies 25 m ² 100 cm breed | 92361 |
| | 25 m ² 67 cm breed | 92362 |
| | 160 gr/m ² | |
|  | Afdekkarton ademend 1x25 m | 94098 |
| | 280 gram, 0,69 mm dik (normaal beloop) | |
|  | Afdekkarton ademend 1x25 m | 94098 |
| | 280 gram, 0,69 mm dik (normaal beloop) | |
|  | TFC A-Kwaliteit Stucloper wit 30 m ² 55 - 70 cm breed | 92357 |
| | Kartondikte variërend van 250 t/m 280 gram beide zijden voorzien van LDPE-coating | |
|  | TFC Non-Woven Premium Afdekvlies 25 m ² 100 cm breed | 92359 |
| | 50 m ² 100 cm breed | 92360 |
| | 180 gram doek en 40 gram anti-slip folie aan de onderzijde | |
|  | TFC Strong Cover 50 m ² 100 cm breed | 92363 |
| | 145 gram doek met een anti-slip LDPE-folie aan de onderzijde | |
|  | Afdekkartonnen 4x5 m | 92220 |
|  | Cover-it Pro-Air ademend 50 m ² 100 cm breed | 94097 |

8.3.4 PARKETENTREE MATTEN

Praktisch







- Geschikt voor intensief huishoudelijk en projectmatig gebruik
- Sterk en veerkrachtig
- Bouclé-pool mat (lusjes in plaats van draadjes)
- Zeer goede vuil- en vochtopname
- Lange levensduur

| | 60x90 cm | 90x150 cm | 130 cm* | 200 cm* | |
|------------------|---|-----------|---------|---------|-------|
| Antraciet |  | 94503 | 94504 | 94501 | 94502 |
| Grijs |  | 94508 | 94509 | 94506 | 94507 |
| Diepblauw |  | 94513 | 94514 | 94511 | 94512 |
| Bruin |  | 94518 | 94519 | 94516 | 94517 |

*Per 10 cm te bestellen

Functioneel





- Schoonloopmat voor normaal huishoudelijk gebruik
- 100% getuft polyamide
- Gesneden polen
- Weekmakervrij dus ideaal voor PVC-vloeren
- Uitstekende vochtopname
- Wasmachinebestendig (max. 30 graden)

| | 100 cm* | 200 cm* | |
|------------------|---|---------|-------|
| Zwart |  | 94531 | 94532 |
| Antraciet |  | 94536 | 94537 |
| Grijs |  | 94541 | 94542 |
| Roest |  | 94546 | 94547 |
| Bruin |  | 94551 | 94552 |
| Beige |  | 94556 | 94557 |

*Per 10 cm te bestellen

Extreem

- Geschikt voor intensief huishoudelijk gebruik
- Natuurlijk uitstraling
- Gemaakt van 100% getuft microvezel met gemêleerd decor
- Anti slip rug
- Neemt extreem veel vocht op
- Wasmachinebestendig (max. 30 graden)

| | 100 cm* | 200 cm* | |
|-------------------|---|---------|-------|
| Antraciet |  | 94570 | 94571 |
| Beige |  | 94574 | 94575 |
| Grijs |  | 94578 | 94579 |
| Zwartgrijs |  | 94582 | 94583 |
| Bruin |  | 94587 | 94586 |

*Per 10 cm te bestellen

Buitenmat

| | Kleur | Afmeting | Artikelnr. | |
|---|------------------------------------|----------|------------|-------|
|  | Luxe buitenmat met aluminium strip | Zwart | 50x80 cm | 94398 |
|  | Luxe buitenmat met antraciet strip | Zwart | 50x80 cm | 94399 |



Promotiemateriaal

| | Aantal | Artikelnr. | |
|--|---------------------------------|------------|-------|
|  | ParketEntree consumenten folder | 25 stuks | 99965 |
|  | Monsterwaaier Praktisch | | 99946 |
|  | Monsterwaaier Functioneel | | 99963 |
|  | Monsterwaaier Extreem | | 99967 |

8.4 REPARATIE



| Reparatiesets | Kleur | Artikelnr. |
|---|-------------|------------|
|  Repair kit express 20 kleuren hardwax 1 smeltpistool (elektrisch) 1 scalpel 1 kunststof spatel 1 handslijppad 2 reparatielakken (één in mat en één zijdemat) | | 83600 |
| | | |
|  Hardwaxset 10 kleuren Softwaxset 10 kleuren Hardwaxset 10 kleuren | Bruintinten | 83602 |
| | Bruintinten | 83603 |
| | Grijstinten | 83604 |
|  QST reparatieset voor laminaat en hout 1 smeltmes, reinigingskam, 7 wasblokjes, schuurpapier | | 07483 |



| Losse hardwaxstaven los | Kleur | Artikelnr. |
|--|-----------------------|------------|
|  | Transparant 701 | 83621 |
| | Wit 655 | 83622 |
| | Sparren 502 | 83623 |
| | Essen licht 504 | 83624 |
| | Licht grijs 01 | 83625 |
| | Hevea 433 | 83626 |
| | Licht kersen 84 | 83627 |
| | Rood beuken 501 | 83628 |
| | Donker pine A2 | 83629 |
| | Bruin beuken 511 | 83630 |
| | Licht iepen 506 | 83631 |
| | Kersen 510 | 83632 |
| | Lichtbruin 520 | 83633 |
| | Licht mahonie 556 | 83634 |
| | Roodbruin mahonie 560 | 83635 |
| | Bruin eiken 561 | 83636 |
| | Donker teak 564 | 83637 |
| | Licht teak 572 | 83638 |
| | Medium teak 573 | 83639 |
| | Zwart 600 | 83640 |

| PVC | Kleur/type | Artikelnr. |
|--|------------|------------|
|  | Wit | 85646 |
| | Grijs | 85647 |
| | Zwart | 85649 |
| | Bruin | 85648 |
| | Beige | 85650 |
|  | Type A | 85644 |
| | Type C | 85645 |

| Vloeibaar hout Rubinol Putty tube 100 gram | Kleur | Artikelnr. |
|---|-------------------|------------|
|  | Beuken donker | 83502 |
| | Eiken/Eiken licht | 83506 |
| | Eiken donker | 83507 |
| | Essen/Ahorn | 83508 |
| | Berken/Grenen | 83509 |
| | Mahonie/Merbau | 83510 |
| | Beuken/Hevea | 83511 |
| | Gerookt eiken | 83512 |
| | Lichtgrijs | 83513 |
| | Zwart | 83514 |
| | Kersen | 83518 |
| | Wengé | 83519 |
| | Kambala/Iroko | 83520 |
| | Walnoot | 83521 |
| Essen wit | 83522 | |



| Stiften | Kleur | Artikelnr. |
|--|-------------------|------------|
|  | Rood/bruin | 83615 |
| | Grijs/donkergrijs | 83619 |
| | Donkerbruin/zwart | 83620 |

| Holle plekken vullers | Inhoud | Artikelnr. |
|---|------------------------------------|-------------|
|  | Stauf holle plekken vuller Repamed | 50 ml 96460 |
| | | |
|  | Lijmspuit met RVS injectienaald | 60 ml 92186 |
| | | |

| Reinigingsdoekjes | Aantal | Artikelnr. |
|---|----------------------------------|-----------------|
|  | PPC Universele reinigingsdoekjes | 90 stuks 92209 |
| | | |
|  | Black Box reinigingsdoekjes | 150 stuks 98995 |
| | | |













8.5 LUCHTBEVOCHTING

8.5.1 HYGROMETERS

| Boneco | | Artikelnr. |
|---|--------------------------------|----------------|
|  | Thermo hygrometer X 200 | 92517 |
| Stadler Form | Kleur | Artikelnr. |
|  | Wit Zwart | 92657 92658 |
|  | Wit Zwart | 92678 92679 |

8.5.2 LUCHTBEVOCHTIGERS









| Boneco | Capaciteit | Artikelnr. |
|---|--|--------------------------|
|  | Hybride Luchtwater reiniger H 300 | 150 m ³ 92500 |
|  | Ultrasone luchtbevochtiger U 200 | 125 m ³ 92524 |
|  | Ultrasone luchtbevochtiger U 350 | 150 m ³ 92525 |
|  | BUltrasone luchtbevochtiger U 700 | 250 m ³ 92526 |
|  | Stoombevochtiger S 250 | 150 m ³ 92527 |
|  | Stoombevochtiger S 450 | 175 m ³ 92528 |
|  | Luchtwater W 200 | 150 m ³ 92529 |
|  | Luchtwater W 300 | 125 m ³ 92532 |
|  | Luchtwater W 400 | 150 m ³ 92533 |
|  | Hybride Luchtwater reiniger H 400 | 150 m ³ 92534 |
|  | Boneco brochure | 1 stuk 92515 |



| Stadler Form | Capaciteit | Kleur | Artikelnr. |
|---|---|---|--|
|  | Fred stoomluchtbevochtiger | 50 m ² /125 m ³ | Wit 92640 |
|  | Anton humidifier | 25 m ² / 63 m ³ | Wit 92630 Zwart 92631 |
|  | Oskar Little koudwater bevochtiger | 30 m ² / 75 m ³ | Wit 92645 Zwart 92646 Titanium 92674 |
|  | Oskar koudwater bevochtiger | 50 m ² / 125 m ³ | Wit 92649 Zwart 92650 Titanium 92675 |
|  | Oskar Big koudwater bevochtiger | 100 m ² / 250 m ³ | Wit 92653 Zwart 92654 |
|  | Eva ultrasone luchtbevochtiger | 80 m ² / 200 m ³ | Wit 92664 Zwart 92665 |
|  | Robert luchtwater | 80 m ² / 200 m ³ | Zwart/Wit 92655 Zilver/Wit 92656 |
|  | Roger little luchtreiniger | 33 m ² | Wit 92707 Zwart 92706 |
|  | Roger little luchtreiniger | 42 m ² | Wit 92667 |
|  | Roger luchtreiniger | 66 m ² | Zwart 92708 |
|  | Roger big luchtreiniger | 104 m ² | Zwart 92709 |
|  | George luchtwater | 60 m ² / 150 m ³ | Wit 92680 |
|  | Stadler Form assortimentsoverzicht | | 1 stuk 92623 |





8.5.3 LUCHTONTVOCHTIGERS

| Stadler Form | Capaciteit | Kleur | Artikelnr. |
|---|--|-------|------------|
|  | Albert ontvochtiger 70 m ² / 175 m ³ | Wit | 92634 |

8.5.4 ACCESSOIRES

| Boneco | Aantal | Artikelnr. |
|---|--|---------------|
|  | Ontkalkingspatroon A250 Aqua Pro | 1 stuk 92501 |
|  | A7417 reiniger-ontkalker | 1 stuk 92439 |
|  | A451 anti kalk pads | 6 stuks 92542 |
|  | Ionic silverstick (Type 7017) | 1 stuk 92513 |
|  | Filterset voor 2241 (Filtertype 5910) | 1 stuk 92520 |
|  | Filterset voor 2251 (Filtertype 5920) | 1 stuk 92521 |
|  | Filterset voor 2441 (Filtertype 7018) | 1 stuk 92523 |
|  | Filtermat W200 (Filtertype AWH201) | 1 stuk 92531 |

| Stadler Form | Aantal | Artikelnr. |
|---|-----------------------------------|---------------|
|  | Water Cube | 92615 |
|  | Fred Magic ball - antikalk | 2 stuks 92663 |

| Stadler Form | Aantal | Kleur | Artikelnr. |
|---|--|--------------|-----------------------|
|  | Anti-kalk cartridge Voor Eva/Anton | | 1 stuk 92620 |
|  | Oskar filterset | | 2 stuks 92661 |
|  | Oskar filterset | | 4 stuks 92662 |
|  | Roger filterset H12 | | 1 stuk 92668 |
|  | Roger Little filterset H12 | | 1 stuk 92669 |
|  | Roger little filterset H14 | | 1 stuk 92710 |
|  | Roger Big filterset H14 | | 1 stuk 92713 |
|  | Roger Big prefilter | Zwart | 1 stuk 92714 |
|  | Roger Little prefilter | Wit Zwart | 1 stuk 92712 92711 |















| Olie | Geur | Artikelnr. |
|---|------------------------|------------|
|  | Etherische olie | |
| | Refresh | 92636 |
| | Relax | 92637 |
| | Revive | 92638 |

9. GEREEDSCHAP

| | | |
|------------|---------------------------------|------------|
| 9.1 | MACHINES | 152 |
| 9.1.1 | SCHUURMACHINES | 152 |
| 9.1.2 | BOENMACHINES | 153 |
| 9.1.3 | ZAAGMACHINES | 154 |
| 9.1.4 | STOFZUIGERS | 156 |
| 9.1.5 | TACKERS | 157 |
| 9.1.6 | COMPRESSOREN | 157 |
| 9.1.7 | FREESMACHINES | 157 |
| 9.1.8 | SCHROEF- EN BOORMACHINES | 158 |
| 9.1.9 | MIXERS | 159 |
| 9.1.10 | OVERIGE MACHINES | 160 |
| 9.2 | LEGMATERIALEN | 161 |
| 9.2.1 | ROLLERS EN KWASTEN | 161 |
| 9.2.2 | KITTEN EN LIJMEN | 163 |
| 9.2.3 | ZAGEN EN ZAAGBLADEN | 164 |
| 9.2.4 | BRADS EN NIETEN | 168 |
| 9.2.5 | SCHROEVEN | 169 |
| 9.2.6 | BOREN | 169 |
| 9.2.7 | MEET- EN AFTEKENGEREEDSCHAP | 169 |
| 9.2.8 | LIJMKAMMEN | 170 |
| 9.2.9 | SCHAREN, STANZEN EN MESSEN | 171 |
| 9.2.10 | BEITELS | 172 |
| 9.2.11 | WALSEN | 172 |
| 9.2.12 | OVERIG | 172 |
| 9.3 | PERSOONLIJKE BESCHERMING | 172 |
| 9.3.1 | ADEMBESCHERMING | 172 |
| 9.3.2 | GEHOORBESCHERMING | 172 |
| 9.3.3 | HANDBESCHERMING | 173 |
| 9.3.4 | KNIEBESCHERMING | 173 |
| 9.3.5 | OVERSCHOENEN | 173 |
| 9.4 | VERBRUIKSMATERIALEN | 174 |
| 9.5 | MAGAZIJN EN BUS | 177 |
| 9.5.1 | OPBERGEN | 177 |
| 9.5.2 | OVERIG | 177 |
| 9.6 | WERKKLEDING EN SCHOENEN | 178 |
| 9.6.1 | SCHOENEN | 178 |
| 9.6.2 | BROEKEN | 178 |
| 9.6.3 | JASSEN EN TRUIEN | 179 |
| 9.6.4 | SHIRTS | 180 |

9.1 MACHINES







9.1.1 SCHUURMACHINES

| Bona | Artikelnr. | Festool | Artikelnr. | Festool | Artikelnr. |
|---|---|---|--|---|--|
|  | Belt bandschuurmachine 200 mm 95360 |  | Rotex RO 90 DX FEQ-Plus 88289 |  | Accu-vlakschuurmachine RTSC 400 3,0 I-Set 88445 |
|  | Belt bandschuurmachine 250 mm 95361 |  | Rotex RO 125 FEQ-Plus 88186 |  | Vlakschuurmachine RTS 400 REQ-Plus 88189 |
|  | Belt UX bandschuurmachine 200 mm 95362 |  | Rotex RO 150 FEQ-Plus 88187 |  | Vlakschuurmachine DTS 400 REQ-Plus 88446 |
|  | Edge XL kanten-schuurmachine 220 mm 95364 |  | Accu-excenter-schuurmachin ETSC 125 3,0 I-Plus 88441 |  | Bandschuurmachine BS 75 E-Set 87841 |
|  | Edge kanten-schuurmachine kort 130 mm 95365 |  | Accu-excenter-schuurmachin ETSC 125 3,0 I-Set 88442 |  | Langnek schuurmachine LHS 2 225 EQI-Plus 88228 |
|  | FlexiSand 1.5 95370 |  | Excenterschuurmachine ETS 125 REQ-Plus 88188 |  | Langnek schuurmachine SET LHS 2 225/CTL 36-Set 88229 |
|  | FlexiSand 1.9 95371 |  | Accu-vlakschuurmachine DTSC 400 3,0 I-Plus 88447 |  | Langnek schuurmachine SET LHS 2 225/CTM 36-Set 88230 |
|  | PowerDrive voor FlexiSand 95369 |  | Accu-vlakschuurmachine DTSC 400 3,0 I-Set 88448 |  | Kanten-schuurmachine ES-ETS 125 REQ-Plus 88238 |
|  | Buffer 1 speed 1600 watt 95372 |  | Accu-Vlakschuurmachine DTSC 400 3,1 I-Plus 88291 |  | Accu-kanten-schuurmachine ES-ETSC 125 3,0 I-Plus 88443 |
| | |  | Accu-vlakschuurmachine RTSC 400 3,0 I-Plus 88444 | | |

TIP!

Schuurbanden, schijven, pads en gaasschijven zijn te vinden in hoofdstuk 5: Schuren of kijk in onze webshop.

9.1.2 BOENMACHINES

| Bona | | Artikelnr. | WOCA | | Artikelnr. |
|---|---|------------|---|---|------------|
|  | Buffer 1 speed 1600 watt | 95372 |  | Floorwasher F35 inclusief grijze borstel | 97346 |
|  | Mini buffer (13 inch) 500 watt | 92131 |  | Borstelset Floorwasher F35 Grijs | 97348 |
|  | FlexiSand 1.5 | 95370 |  | Borstelset Floorwasher F35 Zwart | 97347 |
|  | FlexiSand 1.9 | 95371 | | | |
|  | PowerScrubber | 95378 | | | |
| Overmat | | Artikelnr. | | | |
|  | Floorboy 13" XL300 | 97898 | | | |
|  | Floorboy 13" XL450 | 97899 | | | |
|  | Woodboy 4000/ 32-3 éénschijfs- boenmachine | 97900 | | | |

9.1.3 ZAAGMACHINES

| Festool trek/afkortzaag | | Artikelnr. |
|---|-------------------------------|------------|
|  | Trek/afkortzaag CS 50 EBG-Set | 87559 |
|  | Opklappoten CS 50 KB | 87556 |
|  | Trek/afkortzaag CS 50 EBG | 87561 |
|  | Trek/afkortzaag CS 50 EBG-FLR | 87562 |
|  | Trek/afkortzaag CS 70 EG | 87558 |
|  | Trek/afkortzaag CS 70 EBG | 87563 |
|  | Trek/afkortzaag CS 70 EBG-Set | 87557 |

| Festool tafelzaag | | Artikelnr. |
|---|--------------------------|------------|
|  | Tafelzaag TKS 80 EBS | 88144 |
|  | Tafelzaag TKS 80 EBS-SET | 88145 |

| Festool systainer-zaagtafel | | Artikelnr. |
|---|--|------------|
|  | Systainer-zaagtafel CSC SYS 50 Basic | 88421 |
|  | Systainer-zaagtafel CSC SYS 50 EBI-Basic-Set | 88422 |
|  | Systainer-zaagtafel CSC SYS 50 EBI-Plus | 88423 |
|  | Systainer-zaagtafel CSC SYS 50 EBI-Set | 88424 |
|  | Onderstel UG-CSC-SYS 50 | 88425 |

| Festool decoupeerzaag | | Artikelnr. |
|---|---|------------|
|  | Accu decoupeerzaagmachine PSC 420 EB-LI BASIC | 88197 |
|  | Decoupeerzaagmachine PS 300 EQ-Plus | 88280 |
|  | Decoupeerzaag PS 420 EBQ-Plus 2021 | 88282 |
|  | Decoupeerzaag Carvex PS 420 EBQ-Plus | 87471 |
|  | Accu-decoupeerzaag PSC 420 HPC 4,0 EBI-Plus | 87475 |

| Festool invalcirkelzaag | | Artikelnr. |
|---|---|------------|
|  | Accu-decoupeerzaagmachine PSBC 420 EB-Basic | 88368 |
|  | Accu-decoupeerzaag Carvex PSBC 420 5,2 EBI-Plus | 87476 |
|  | Accu-decoupeerzaagmachine PSC 420 HPC4,0 EBI-Set | 88367 |
|  | Accu-invalcirkelzaagmachine TSC55 KEB-Basic | 88287 |
|  | Accu-invalcirkelzaagmachine TSC 55 KEBI-Plus/XL-FS | 88436 |
|  | Accu-invalcirkelzaagmachine TSC 55 5,0 KEBI-Plus/XL | 88435 |
|  | Invalcirkelzaagmachine TS 75 EBQ-Plus-FS | 87521 |
|  | Invalcirkelzaagmachine TS 60 KEBQ-Plus | 88403 |
|  | Invalcirkelzaagmachine TS 60 KEBQ-Plus-FS | 88404 |
|  | Invalcirkelzaagmachine TS 55 FEBQ-Plus-FS | 88286 |

9.1.3 ZAAGMACHINES (vervolg)

| Festool plintenzaag | Artikelnr. |
|--|------------|
|  Plintenzaag SYM 70 RE | 87601 |
|  Verhoging EH-SYS-SYM 70 voor SYM 70 E | 87604 |
| Festool afkortzaag | Artikelnr. |
|  Accu-afkortzaag KSC 60 EB-Basic | 88388 |
|  Accu-afkortzaag KSC 60 EB 5,0 I-Plus | 88439 |
|  Accu-afkortzaag KSC 60 5,0 I-UG-Set | 88440 |
|  Afkortzaag Kapex KS 60 E | 87609 |
|  Afkortzaag Kapex KS 60 E-SET | 87610 |
|  Afkortzaag Kapex KS 120 REB | 87611 |
|  Afkortzaag KS 120 REB-Set-MFT | 88185 |
|  Afkortzaag + onderstel Kapex KS 120 REB-Set-UG | 87612 |

| Festool afkortzaag | Artikelnr. |
|--|------------|
|  Onderstel met 2 afkortaanslagen UG-KA-Set (KS 120) | 87613 |
|  Onderstel UG-Kapex (KS 120) | 87614 |
|  Hoeksteun AB-KA-UG/2 voor KS 120 | 87619 |
| Festool pendelkapzaagmachine | Artikelnr. |
|  Accu-pendelkapzaagmachine HKC 55 5,0 EBI-Plus-SCA | 88437 |
|  Accu-pendelkapzaagmachine HKC 55 5,0EBI-Set-FSK420 | 88438 |
|  Accu-Pendelkapzaagmachine HKC 55 EB-Basic | 88307 |
| Festool isolatiezaag | Artikelnr. |
|  Accu isolatiezaag-machine ISC 240 LI EB BASIC | 88199 |
| Festool oscillerende machine | Artikelnr. |
|  Accu-oscillerende machine OSC 18 E-Basic | 88249 |
|  Accu-Oscillerende machine OSC 18 E-Basic-Set | 88250 |

| Festool oscillerende machine | Artikelnr. |
|---|------------|
|  Accu-oscillerende machine OSC 18 HPC4,0 EI-Plus | 88245 |
|  Accu-oscillerende machine OSC 18 HPC4,0 EI-Set | 88246 |
| Festool zwaardzaag | Artikelnr. |
|  Zwaardzaag IS 330 EB | 88142 |
|  Zwaardzaag SSU 200 EB-Plus | 88419 |
|  Zwaardzaag SSU 200 EB-Plus-FS | 88420 |

9.1.4 STOFZUIGERS

| Bona | Artikelnr. |
|---|---|
|  | Dust Care Single DCS70 95375 |
|  | Dust Care Single DCS25 95376 |
|  | Longopac navulstofzak BonaDCS/HTC GL25TD 4x20m1 95342 |

| Festool stofzuiger | Artikelnr. |
|--|---|
|  | Mobiele stofzuiger in systainer CTL SYS 87861 |
|  | Stofzuiger CT 15 E 88151 |
|  | Stofzuiger CT 15 E-Set 88152 |
|  | Stofzuiger CTL 26E 87872 |
|  | Stofzuiger CTL 36E Cleantec 87874 |
|  | Stofzuiger CTL MINI I Bluetooth 87951 |
|  | Stofzuiger CTL MIDI I Bluetooth 87952 |

| Festool bouwstofzuiger | Artikelnr. |
|---|---|
|  | Bouwstofzuiger CTL 26 E AC-RENOFIX 88191 |
|  | Bouwstofzuiger CTL 36 E AC-RENOFIX 88192 |
|  | Selfclean filterzak 5 stuks FIS-CTL MIDI 87895 CT22 87896 CT26 87897 CT36 87898 |

| Festool stofafzuiger | Artikelnr. |
|---|--|
|  | Stofafzuigmobiel CTL 36 E AC Planex 88231 |
|  | Stofafzuigmobiel CTM 36 E AC-Planex 88232 |
|  | Accu-stofafzuiger CTLC SYS I-Basic 88392 |
|  | Accu-stofafzuiger CTLC SYS HPC4,0 I-Plus 88393 |
|  | Accu-stofafzuiger CTMC SYS I-Basic 88394 |
|  | Accu-stofafzuiger CTMC HPC4,0 I-Plus 88395 |
|  | Selfclean filterzak voor CTL SYS 5 stuks 87862 |

| Festool stofafzuiger | Artikelnr. |
|---|--|
|  | Accu-stofafzuiger CTLC MINI I-Basic 88396 |
|  | Accu-stofafzuiger CTLC MINI I-Plus 88449 |
|  | Accu-stofafzuiger CTLC MIDI I-Basic 88398 |
|  | Accu-stofafzuiger CTLC MIDI I-Plus 88450 |
|  | Accu-stofafzuiger CTMC MIDI I-Basic 88400 |
|  | Accu-stofafzuiger CTMC MIDI I-Plus 88451 |
|  | Selfclean filterzak FIS-CT MINI/MIDI-2 5 stuks 87954 |



Stofzuigerzakken, zie hoofdstuk 9.4: Verbruiksmaterialen

9.1.5 TACKERS

| Union | | Artikelnr. |
|---|--|------------|
|  | Tacker voor minibrads 1AC/J-32 | 87071 |
|  | Tacker voor minibrads 2A/J-32 | 87103 |
|  | Tacker voor microbrads 1AH/JA-30 | 87070 |
|  | Tacker voor microbrads 1N/JA-25N | 87102 |
|  | Tacker 1AE/0-16 voor O-nieten | 87072 |
|  | Tacker 1AB/E-25ULN voor 9-25 mm E-nieten | 87087 |
|  | Tacker 4AH/Z-50U voor 25-50 mm L-krammen | 87096 |
|  | Afwerknagelmachine 3AM/N-50U | 87104 |
|  | Floorstapler 3MF/SB50U | 87105 |































9.1.6 COMPRESSOREN

| Union | | Artikelnr. |
|---|---|------------|
|  | Compressor C-Orkan 169H 24 liter | 87068 |
|  | Kleine compressor C-Comprit 105 3 liter | 87106 |
|  | Compressor C-Shuttle 240 5 liter | 87107 |
|  | Compressor C-Pioneer 240 10 liter | 87108 |

9.1.7 FREESMACHINES





| Festool | | Artikelnr. |
|---|---|------------|
|  | Bovenfreesmachine OF 1400 EBQ-Plus | 88335 |
|  | Bovenfreesmachine OF 1010 EBQ-Plus | 88350 |
|  | Domino freesmachine DF 500 Q-Plus | 88359 |
|  | Renovatieslijpmachine RG 130 ECI-Plus | 88452 |
|  | Renovatieslijpmachine RG 130 ECI-Set DIA TH | 88453 |
|  | Balancer BR-RG 150 | 88270 |
|  | Vloergeleiding BG-RG 150 | 88265 |
| Collomix | | Artikelnr. |
|  | Betonslijper CMG 2600 | 92444 |

9.1.8 SCHROEF- EN BOORMACHINES

| Festool schroefautomaat | | Artikelnr. | Festool schroefboormachine | | Artikelnr. | Festool klopboormachine | | Artikelnr. | | | | | | | | | | | | | | | |
|--|---|------------|---|--|------------|---|---|-------------------|---|---------------------------------------|---|---|--|--|--|--|-------|---|---|-------|---|--|-------|
|  | Accu-slag-schroevendraaier TID 18-Basic | 88172 |  | Accu-schroef-boormachine C 18 HPC 4,0 I-Set | 88426 |  | Accu-klopboormachine TPC 18/4 I-Basic | 88284 | | | | | | | | | | | | | | | |
|  | Accu-slag-schroevendraaier TID 18 HPC4,0 I-Plus | 88173 |  | Accu-schroef-boormachine T 18+3 HPC 4,0 I-Plus | 88374 |  | Accu-klopboormachine TPC 18/4 5,0/4,0I-Set/XL | 88431 | | | | | | | | | | | | | | | |
|  | Schroefautomaat DWC 18-2500-Basic | 88255 |  | Accu-schroef-boormachine T18+3 HPC 4,0 I-Set | 88427 | <table border="1"> <thead> <tr> <th colspan="2">Festool boorhamer</th> <th>Artikelnr.</th> </tr> </thead> <tbody> <tr> <td></td> <td>Accu-boorhamer BHC 18-Basic</td> <td>88433</td> </tr> <tr> <td></td> <td>Accu-boorhamer BHC 18 HPC 4,0 I-Plus</td> <td>88434</td> </tr> </tbody> </table> | | Festool boorhamer | | Artikelnr. |  | Accu-boorhamer BHC 18-Basic | 88433 |  | Accu-boorhamer BHC 18 HPC 4,0 I-Plus | 88434 | | | | | | | |
| Festool boorhamer | | Artikelnr. | | | | | | | | | | | | | | | | | | | | | |
|  | Accu-boorhamer BHC 18-Basic | 88433 | | | | | | | | | | | | | | | | | | | | | |
|  | Accu-boorhamer BHC 18 HPC 4,0 I-Plus | 88434 | | | | | | | | | | | | | | | | | | | | | |
|  | Schroefautomaat DWC 18-4500-Basic | 88256 |  | Accu-schroef-boormachine TDC 18/4 I-Basic | 88372 | | | | | | | | | | | | | | | | | | |
|  | Schroefautomaat DWC 18-2500 Li 3,1-COMPACT | 88020 |  | Accu-schroef-boormachine TDC 18/4 5,0/4,0 I-Plus | 88428 | | | | | | | | | | | | | | | | | | |
| <table border="1"> <thead> <tr> <th colspan="2">Festool schroefboormachine</th> <th>Artikelnr.</th> </tr> </thead> <tbody> <tr> <td></td> <td>Accu-schroef-boormachine T 18+3 LI BASIC</td> <td>88208</td> </tr> <tr> <td></td> <td>Accu-schroef-boormachine T 18+3-Basic</td> <td>88215</td> </tr> <tr> <td></td> <td>Accu-schroef-boormachine C 18 LI Basic</td> <td>88181</td> </tr> <tr> <td></td> <td>Accu-schroef-boormachine C 18 HPC 4,0 I-Plus</td> <td>88183</td> </tr> </tbody> </table> | | | Festool schroefboormachine | | Artikelnr. |  | Accu-schroef-boormachine T 18+3 LI BASIC | 88208 |  | Accu-schroef-boormachine T 18+3-Basic | 88215 |  | Accu-schroef-boormachine C 18 LI Basic | 88181 |  | Accu-schroef-boormachine C 18 HPC 4,0 I-Plus | 88183 |  | Accu-schroef-boormachine TDC 18/4 5,0/4,0 I-Set | 88429 |  | Accu-schroef-boormachine TPC 18/4 5,0/4,0 I-Plus | 88430 |
| Festool schroefboormachine | | Artikelnr. | | | | | | | | | | | | | | | | | | | | | |
|  | Accu-schroef-boormachine T 18+3 LI BASIC | 88208 | | | | | | | | | | | | | | | | | | | | | |
|  | Accu-schroef-boormachine T 18+3-Basic | 88215 | | | | | | | | | | | | | | | | | | | | | |
|  | Accu-schroef-boormachine C 18 LI Basic | 88181 | | | | | | | | | | | | | | | | | | | | | |
|  | Accu-schroef-boormachine C 18 HPC 4,0 I-Plus | 88183 | | | | | | | | | | | | | | | | | | | | | |
| | | |  | Accu-slag- en schroefboormachine TID18 5,0/4,0-Set TPC18 | 88432 | | | | | | | | | | | | | | | | | | |

9.1.9 MIXERS

| Collomix | Artikelnr. |
|---|---|
|  | Mengmachine Xo1R HF 92380 |
|  | Mengmachine Xo4R HF 92382 |
|  | Mobiel mengapparaat LevMix 92424 |
|  | Waterdoseer-apparaat AQiX 92313 |
|  | Mengemmer voor LevMix 75 liter 92428 |
|  | Uitgiet snavel voor LevMix 92425 |
|  | Mobiele stofafzui-ging Dust.Ex 92420 |

| Collomix mengstaaf | Artikelnr. |
|---|---|
|  | Mengstaaf DLX 120 HF M14 92406 M14 92408 |
|  | Mengstaaf DLX 152 HF M14 92407 M14 92409 |
|  | Mengstaaf KR 120 HF M14 92400 M14 92402 |
|  | Mengstaaf KR 140 HF M14 92401 M14 92403 |
|  | Mengstaaf WK 120 HF M14 92396 M14 92398 |
|  | Mengstaaf WK 140 HF M14 92397 M14 92399 |
|  | Mengstaaf LX 70 S 92404 |
|  | Mengstaaf LX 90 S 92405 |
|  | Mengstaaf FM 80 S 92410 |
|  | Mengstaaf WK 90/500 S 92395 |
|  | Mengstaaf VLX 160 HF voor LevMix 92426 |
|  | Mengstaaf VLX 163 HF voor LevMix 92427 |

MENGMACHINE TOEPASSINGS-OVERZICHT

Hier vind je voor elk mengsel de juiste oplossing.



SCAN DE QR-CODE

Scan de QR-code en download de PDF

| Festool | Artikelnr. |
|---|---|
|  | Mengmachine MX 1000 RE EF HS3R 88257 |
|  | Mengmachine MX 1600/2 RE EF HS3R 88258 |
|  | Mengmachine MX 1000 RE EF HS2 88293 |
|  | Mengmachine MX 1200 RE EF HS3R 88294 |
|  | Mengmachine MX 1200 RE EF HS2 88295 |
|  | Mengmachine MX 1200/2 RE EF HS3R 88296 |

MIXWIJZER

Niet helemaal zeker welke mixer en mengstaaf je nodig hebt voor jouw project? Dankzij de MIX Atlas / Mix wijzer van Collomix vind je eenvoudig de juiste mixoplossing voor jouw klus. Filter op materiaal, producent of bouwsector en zie direct welke mixers Collomix adviseert.



SCAN DE QR-CODE

Scan de QR-code of ga naar: Mixingatlas.com

9.1.9 MIXERS (vervolg)

| Festool | Artikelnr. |
|---|---|
|  | Afzuigadapter Kuip MX - A 88259 |
|  | Roergarde CS 120x600 M14 88028 |
|  | Spiraalgarde HS 3 160x600 R M14 92257 |
|  | Roerstaaf voor mixen (PU-)lijmen 92140 |
|  | Spiraalgarde met ring RS 2 85x400 SW 8 92252 |

| Pajarito | Artikelnr. |
|---|--|
|  | Roerstaaf voor egalisatie 92261 |

9.1.10 OVERIGE MACHINES

| Festool | Artikelnr. |
|---|--|
|  | Festool bouwradio SYS Rock BR10 DAB+ 87409 |
|  | Werklamp SET Festool DUO 88299 |
|  | Telefoon Oplader PHC 18 88348 |
|  | Power Station SYS-PST 1500 Li HP 88298 |
|  | Mobiële werkplaats MW 1000 basic 87441 |
|  | Mobiële werkplaats MW 1000 set 87440 |
|  | Tafel TSB/1-MW 1000 87443 |
|  | Multifunctionele tafel MFT/3 88247 |
|  | Accu-Haakseslijper AGC 18-125 EB-Basic 88251 |
|  | Accu-haakseslijper AGC18-125 5,0 EBI-Plus 88454 |

































| Festool | Artikelnr. |
|---|--|
|  | Accu-Tegelslijper DSC-AGC 18-125 EB-Basic 88252 |
|  | Tegelslijper DSC-AG 125 FH-Plus 88418 |
|  | Renovatieslijpmachine RG 130 ECI-Plus 88452 |
|  | Renovatieslijpmachine RG 130 ECI-Set DIA TH 88453 |

| Ventilator | Artikelnr. |
|---|--|
|  | Professionele ventilator Master DF 20 P 87434 |
|  | Professionele ventilator Master DF 30 P 87439 |

| Buigmachine | Artikelnr. |
|---|---|
|  | Buigmachine BG1 (makkelijk buigbare profielen) 41501 |
|  | Buigmachine BG2 (voor buigbare trapprofielen) 41502 |

9.2 LEGMATERIALEN

























9.2.1 ROLLERS EN KWASTEN

| PPC | Artikelnr. | Bona | Artikelnr. | ROYL | Artikelnr. |
|---|--|---|--|---|--|
|  | Lakroller microvezel 10 cm breed 92197 25 cm breed 92191 50 cm breed 92137 |  | SuperCoat lakroller 10 cm breed 10 stuks 96806 25 cm breed 96807 |  | Mengvaatje 98877 |
|  | Velours/mohairroller 10 cm breed 92190 25 cm breed 92192 |  | Waterlakroller wit grondlak 25 cm 96730 |  | Mengvaatje Inzet 98878 |
|  | Voorstrijkroller 18 cm 92327 |  | Beugel voor lakroller met Quick Release 96735 |  | Schenktuit voor 1 liter blik 98879 |
|  | Voorstrijkroller 25 cm met beugel 92208 | Dr. Schutz | Artikelnr. | RIGO | Artikelnr. |
|  | Beugel voor lakroller 10 cm breed 92198 25 cm breed 92193 |  | Aquatop lakroller 25 cm breed 91471 50 cm breed 91483 |  | Rolbak - professionele lakbak 9 liter 92183 |
|  | Beugel voor lakroller 50 cm 92139 |  | Beugel voor aquatop lakroller 25 cm breed 91482 50 cm breed 91484 |  | Inlay voor lakbak 5 stuks 92184 |
|  | Aluminium telescoopsteel 100-160 cm 92127 | OSMO | Artikelnr. | WOCA | Artikelnr. |
|  | Telescoopsteel deluxe 115-200 cm 92138 |  | Waxoliekwast 25 mm 98271 50 mm 98272 100 mm 98273 |  | Oliespons 6 stuks 97327 |
|  | Lakbakje Klein 15 x 32 cm 92187 Middel 26 x 32 cm 92334 Groot 33 x 50 cm 92188 |  | Vloerborstel 220 mm 98280 | Overig | Artikelnr. |
|  | Grote plastic lakemmer 12 L 98977 |  | Losse roller 25 cm 1 stuk 98283 12 stuks zonder koker 98296 |  | Inwashoes 30 cm 92101 |
|  | Inlay voor grote plastic lakemmer 12 L 5 stuks 98976 |  | Roller- & verfwastset 98284 |  | Lakhoes 30 cm 92102 |
|  | Rooster voor lakemmer 12 L 98978 | | |  | T-houder 30 cm 92103 |
|  | Lakzeef RVS 200 mm 98979 | | |  | Bezemsteel 170 cm (Ø 2,8 cm) 92194 |
| | | | |  | Taski trekker 92129 |

9.2.1 ROLLERS EN KWASTEN (vervolg)



















| Overig | Artikelnr. | Tapes | Artikelnr. |
|---|---|---|--|
|  | Taski spons geel 92128 |  | Afplaktape 25 mm x 50 m 92213 36 mm x 50 m 92214 50 mm x 50 m 92215 100 mm x 50 m 92217 |
|  | Verfroller nylon met streep voor 2K verf/epoxy 10 cm breed 92329 25 cm breed 92330 25 cm breed 8 mm 92317 |  | Maskeertape Washi-papier gold UV30 25 mm x 50 m 92342 |
|  | Lakroller profi microvezel oranje 10 cm breed 92133 25 cm breed 92134 |  | Ondervloerentape 5 cm x 50 m 86121 |
|  | Vorstrijker met beugel 18 cm 92327 |  | QST Zelfklevend plakband voor ondervloeren 50 m¹ 09216 |
|  | Blokkwast 150 mm 92200 |  | Tape universeel weekmaker-bestendig (36 rol) 50 mm x 50 m 82751 |
|  | Bokkenpoot/radiatorkwast 50 mm 92201 |  | Dubbelzijdige plinten & profielen tape 25 mm x 25 m 92218 |
|  | Wegwerp radiatorkwast 2" 92324 |  | Ducttape grijs 48 mm x 50 m 92219 |
|  | Wegwerpkwast 30 mm 92203 50 mm 92205 70 mm 92207 |  | Renoboard tape 50 mm x 50 m 86598 |
|  | Patentpunt schilderskwast Professional 92321 |  | Handafroller voor tape 87002 |
|  | Goudhaantje patentpunkwast traditioneel 92322 | | |
|  | Goudhaantje patentpunkwast Futura 280 92323 | | |
|  | Bewaarbox voor parketlakroller 92196 | | |

























9.2.2 KITTEN EN LIJMEN

| PPC | Artikelnr. | Soudal | Artikelnr. | Overig | Artikelnr. |
|---|---|---|--|---|---|
|  | PPC High Tack plintenkit wit 290 ml 96828 |  | Secondelijm 84050 |  | Spaan RVS 27 cm 92181 35 cm 92180 |
|  | PPC High Tack plintenkit zwart RAL 9005 290 ml 96827 | Thomsit | Artikelnr. |  | Plamuurmes RVS 6 cm 92182 |
|  | Sfeerplinten high tack montagekit wit 290 ml 16200 |  | R729 giethars dekvloerreparatie 600 ml 96596 |  | Kitstrijker voor snel en netjes afkitten 92185 |
| Kerakoll | Artikelnr. | Stauf | Artikelnr. | | |
|  | SLC Eco MP100 vullijm 500 ml 96646 |  | Repacoll S 1K SPU montagekit 290 ml 96459 | | |
|  | Plinten & profielen Kit 290 ml 96830 |  | Holle plekken vuller Repamed 50 ml 96460 | | |
|  | Soudaseal Supertack montagekit wit 290 ml 96834 | Overig | Artikelnr. |  | Kitpistool professioneel 84192 |
|  | Traptredenmontagekit Purocol Express 1K PU 290 ml 96833 |  | Sputmond voor standaard kittoker 5 stuks 84051 |  | Draaibare spuitmond voor standaard kittoker 5 stuks 84052 |
|  | Soudal Acryrub acrylkit 310 ml Wit 96840 |  | Lijmspuit met RVS injectienaald 60 ml 92186 |  | Mitre Bond Pen snellijmsysteem 83200 |
|  | Soudal Acryrub acrylkit 310 ml Zwart 96841 |  | UltraBond snellijmsysteem (spray) 50 ml 83203 | | |
|  | Soudaseal Transpacryl - transparant 290 ml 96832 |  | UltraBond snellijmsysteem (spray) 100 ml 83204 | | |
|  | Soudal PU construct XF snelle uitharding 310 ml 84054 | | | | |
| SILICONEN- & ACRYLKITTEN OP KLEUR | | | | | |
| Deze vind je in hoofdstuk 3: Lijmen & Kit > 3.8 kitten op kleur of kijk in onze webshop | | | | | |

TIP!























9.2.3 ZAGEN EN ZAAGBLADEN

| Festool | Artikelnr. |
|---|---|
| Decoupeerzaagblad | |
|  | Snel & grof S75/4 FSG (5 stuks) 87513 |
|  | Snel & grof S105/4 FSG (5 stuks) 87514 |
|  | Hout fine cut S75/2,5 R (5 stuks) 87961 |
|  | Hout straight cut S75/2,8 (5 stuks) 87962 |
|  | Hout straight cut S105/2,8 (5 stuks) 87963 |
|  | Hout straight cut S145/2,8 (5 stuks) 87964 |
|  | Hout curves S75/4 K (5 stuks) 87965 |
|  | Hout curves S75/1,4 K (5 stuks) 87966 |
|  | Hout basic S 75/4 (5 stuks) 87970 |
|  | Hout basic S 105/4/5 (5 stuks) 87971 |
|  | Hout universal S145/ 4 FSG (5 stuks) 87974 |
|  | Decoupeer-zaagbladset hout STS-Sort/25W 87975 |
|  | Laminaat HM 90/3,3/1 87967 |
|  | Metaal HS 75/1,2 BI (5 stuks) 87968 |
|  | Metaal HS 105/1 BI (5 stuks) 87969 |
|  | Hout zaagblad HSB 100/HCS 87510 |
|  | Hout-zaagblad HSB 100/Bi/OSC 88032 |
|  | Diamant-zaagblad SSB 90/OSC/DIA 88033 |





| Festool | Artikelnr. |
|---|----------------------------------|
| Cirkelzaagblad aluminium | |
|  | HW 168x1,8,20 F/FA52 88409 |
|  | 160x1,8x20 F/FA52 (dun) 88314 |
|  | 190x2,6 FF TF58 (CS 50) 87576 |
|  | 225x2,6x30 TF68 (CS 70) 87584 |
|  | 254x2,4,30 TF80 A (TKS 80) 88171 |
|  | 260x2,4x30 TF68 (KS 120) 87618 |
| Cirkelzaagblad hout/zachte kunststoffen | |
|  | HW 168x1,8x20 PW16 88405 |
|  | 225x2,6x30 W32 (CS 70) 87581 |
|  | 225x2,6x30 W48 (CS 70) 87582 |
|  | 225x2,6x30 PW18 (CS 70) 87583 |
|  | 216x2,3x30 W48 (SYM 70) 87608 |
|  | 216x2,3x30 W60 (KS 60) 87528 |
|  | 254x2,4x30 PW24 (TKS 80) 88167 |
|  | 260x2,4x30 W60 (KS 120) 87615 |
|  | 260x2,4x30 W80 (KS 120) 87616 |
| Cirkelzaagblad laminaat | |
|  | 210x2,4x30 TF60 87526 |
|  | 190x2,6 FF TF54 (CS 50) 87577 |
|  | 216x2,3x30 WZ/FA60 (KS 60) 87527 |
|  | 225x2,6x30 TF64 (CS 70) 87578 |
|  | 260x2,4x30 WZFA64 (KS 120) 87617 |
|  | 160x2,2x20 TF48 (TS 55) 87537 |
|  | 160x1,8x20 TF52 (dun) 88313 |
|  | HW 168x1,8x20 TF52 88408 |
|  | 254x2,4x30 TF80 L (TKS 80) 88170 |

| Festool | Artikelnr. |
|---|-------------------------------------|
| Fijngetand cirkelzaagblad | |
|  | HW 168x1,8x20 WD42 88407 |
|  | 160x1,8x20 WD42 (dun) 88311 |
|  | 210x2,4x30 W52 87525 |
|  | 160x2,2x20 W48 (TS 55) 87535 |
|  | 190x2,4 FF W48 (CS 50) 87575 |
|  | 254x2,4x30 W60 (TKS 80) 88169 |
| Universeel cirkelzaagblad | |
|  | 160x2,2x20 W28 (TS 55) 87534 |
|  | HW 168x1,8x20 W28 88406 |
|  | 160x1,8x20 W28 (dun) 88312 |
|  | 210x2,4x30 W36 87524 |
|  | 254x2,4x30 W40 (TKS 80) 88168 |
| Cirkelzaagblad DIA bouw materiaal | |
|  | 168x1,8x20 F4 88410 |
| Speciaal cirkelzaagblad | |
|  | 160x2,2x20 TF52 (TS 55) 87536 |
| Hout zaagblad | |
|  | OS-400 HSB 50/35/J (5 stuks) 87496 |
|  | OS-400 USB 50/35/Bi (5 stuks) 87498 |
|  | OS-400 HSB 50/45/J (5 stuks) 87500 |
| Universeel zaagblad | |
|  | OS-400 USB 78/42/Bi 87503 |
|  | OS-400 USB 50/65/Bi (5 stuks) 87506 |
| Hout zaagblad | |
|  | HSB 50/65/J/OSC (5 stuks) 88034 |
| | HSB 50/35/J/OSC (5 stuks) 88035 |

9.2.3 ZAGEN EN ZAAGBLADEN (vervolg)

| Festool | Artikelnr. | PPC | Artikelnr. | PPC | Artikelnr. |
|---|--|---|------------------------------------|---|---|
|  | Universeel zaagblad |  | HM cirkelzaagblad |  | HM cirkelzaagblad aluminium/trespa |
| | USB 50/35/Bi/OSC (5 stuks) 88036 | | 160x2,2x20 24T (TS-55) 88600 | | 160x1,8x20 60T (dun) 88631 |
| | USB 78/32/Bi/OSC (5 stuks) 88037 | | 160x1,8x20 24T (TS-55 dun) 88627 | | 160x2,4x20 60T (TS55) 88632 |
| | USB 78/42/Bi/OSC (5 stuks) 88038 | | 160x2,2x20 36T (TS-55) 88601 | | 190x2,6x20 60T (CS55) 88633 |
| | USB 50/65/Bi/OSC (5 stuks) 88039 | | 160x1,8x20 36T (TS-55 dun) 88628 | | 190x2,6x20 60T (CS55) 88633 |
|  | Segmentzaagblad SSB 32/OSC 88044 | | 160x2,2x20 48T (TS-55) 88602 | | 210x2,6x30 60T (TS75) 88634 |
| | | | 160x1,8x20 48T (TS-55 dun) 88629 | | 216x2,6x30 60T (KS60) 88635 |
| | | | 190x2,6x30 24T (rond asgat) 88604 |  | HM afkortaagblad |
| Hultafors | Artikelnr. | | 190x2,6x30 48T (rond asgat) 88605 | | 216x3,0x30 48T (Kapex KS60) 88610 |
|  | Handzaag professioneel HBX fijn 85615 |  | 210x3,0x30 24T (TS-75) 88606 | | 250x3,0x30 48T (HK-85) 88611 |
| | | | 210x3,0x30 48T (TS-75) 88607 | | 260x3,0x30 48T (Kapex KS120) 88612 |
|  | Metaalbeugelzaag HMX 85622 |  | 250x3,0x30 24T (HK-85) 88608 |  | HM-zaagbladen prof. 3-delige set 160 x 20 mm 88599 |
| | | | 250x3,0x30 48T (HK-85) 88609 | | IJzerzaag 150 mm 85136 |
|  | Reservezaagblad metaalzaag HM 12-24x4 85623 |  | 225x3,0x30 24T (CS-70) 88619 |  | |
| | | | 225x3,0x30 48T (CS-70) 88620 | | Los zaagblad voor ijzerzaag 150 mm 85137 |
| PPC | Artikelnr. |  | indus. 160x1,8x20 48T (dun) 88630 |  | Multitool zaagblad |
|  | Decoupeerzaagblad S75 fijn omgekeerde tand (25 stuks) 87516 | | Indus.190x2,6x20 48T (CS 50) 88623 | | Bimetaal recht/breed RV 85141 |
| | | | Indus.190x2,6x20 60T (CS 50) 88624 | | Bimetaal recht/smal RV 85143 |
|  | Decoupeerzaagblad S60 Bi omgekeerde tand (5 stuks) 87517 |  | Prof.190x2,6x30 48T (CS 50) 88621 | | Hout recht/smal RV 85144 |
| | | | Prof. 190x2,6x20 60T (CS 50) 88622 | | Driehoek hout/breed SV 85145 |
|  | Decoupeerzaagblad S75/2,5 (10 stuks) 88614 | | Prof. 190x2,6x30 24T (CS 50) 88626 | | Bimetaal/halfmond RV 85146 |
| | | | Prof. 160x2,6x20 48T 88625 | | |
|  | S75/4 FS (10 stuks) 88615 | | Prof. 210x3,0x30 60T 88638 | | |
| | | | Prof. 216x3,0x30 60T 88639 | | |
|  | S75/2,5 Bi (10 stuks) 88616 | | Prof. 260x3,0x30 60T 88640 | | |
| | | | Prof. 300x3,2x30 48T 88636 | | |
|  | S75/4 FSG (10 stuks) 88617 | | Prof. 300x3,2x30 60T 88637 | | |
| | | | | | |
|  | S105/4 FSG (10 stuks) 88618 | | | | |

9.2.3 ZAGEN EN ZAAGBLADEN (vervolg)

| PPC | Artikelnr. | PPC | Artikelnr. | | |
|---|---|---|--|----------------------------------|-------|
|  | Fein Supercut |  | Starlock | | |
| | Bimetaal recht/ breed RV | | 85151 | MB221 Bi-metaal zaagblad 50mm | 85188 |
| | Bimetaal recht/ smal RV | | 85153 | MB126 Precisie zaagblad 35mm | 85189 |
| | Hout recht/ smal RV | | 85154 | MB222 Bi-metaal zaagblad 28mm | 85190 |
| | Driehoek hout breed SV | | 85155 | MB223 Bi-metaal zaagblad 44mm | 85191 |
| Bimetaal/ half rond RV | 85156 | MB106 HSS segmentzaagblad 85mm | 85192 | | |
|  | Wolfraam Stalen Zaagblad 50.8 mm voor Minizaag | 88708 | MB205 schuurvoet 93x93x93 | 85193 | |
|  | Multiblade | MB118 hardmetaal zaagblad | 85194 | | |
| | MB85 Precisie zaagblad | 85160 | MB165 Flexibele spatel | 85195 | |
| | MB71 Bi-metalen zaagblad | 85161 | MB225 zaagblad breed curved | 85196 | |
| | MB24 Bi-metalen zaagblad | 85162 | MB230 zaagblad breed curved Japanse tand | 85197 | |
| | MB86 Lang zaagblad | 85163 | MB228 zaagblad breed Long-life bi-metaal | 85198 | |
| | MB37 Bi-metalen zaagblad | 85164 | MB251 multimes | 85199 | |
| | MB85S Precisie zaagblad | 85165 | | | |
| | MB24S Bi-metalen zaagblad | 85166 | | | |
| | MB86S Lang zaagblad | 85167 | | | |
| | MB71S Bi-metalen zaagblad | 85168 | | | |
| | MB37S Bi-metalen zaagblad | 85169 | | | |
| | MB83 Precisie zaagblad | 85170 | | | |
| | MB83S Precisie zaagblad | 85171 | | | |



MAKKELIJK AFGEHAALD "THEO DRAAGT GRAAG EEN PLINTJE BIJ"

PPC doet alles voor het gemak van de vloerspecialist. Ons motto is "Graag gebracht!" maar soms is afhalen niet zo gemakkelijk. Met vestigingen in **Wijk bij Duurstede, Amsterdam, Den Haag, Eindhoven, Groningen en Nieuwegein** is er altijd een PPC filiaal in de buurt waar je jouw benodigde producten kan ophalen.

Van maandag tot en met vrijdag van 6:30 – 17:30 uur
en op zaterdag van 7:30 – 16:00 uur.

In het filiaal in Groningen staan Theo en zijn collega's voor je klaar met de koffie om jou te voorzien van vakkundig advies.

**BREED EN INNOVATIEF
ASSORTIMENT**

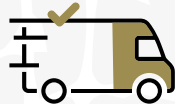

**GRAAG
GEBRACHT!**

**VAKKUNDIGE EN KLANTVRIENDELIJKE
MEDEWERKERS**



**MAKKELIJK
AFGEHAALD**

PPC
ALLES VOOR DE
PARKETTEUR





**GUNSTIGE
RETOURREGELING**



**MET GROOT GEMAK
BESTELD**



9.2.4 BRADS EN NIETEN



| PPC brads | Artikelnr. |
|--|--|
|  | Microbrads gegalvaniseerd (10.000 stuks) |
| | 21 Ga-M 10mm 87255 |
| | 21 Ga-M 12mm 87254 |
| | 21 Ga-M 15mm 87256 |
| | 21 Ga-M 18mm 87257 |
|  | Minibrads gegalvaniseerd (5.000 stuks) |
| | 18 Ga 13 mm F13 87262 |
| | 18 Ga 15 mm F15 87263 |
| | 18 Ga 20 mm F20 87264 |

| Union brads | Artikelnr. |
|--|---|
|  | Brads bruin |
| | JA13 bruin 87111 (20.000 stuks) |
| | JA16 bruin 87112 (20.000 stuks) |
| | JA18 bruin 87113 (20.000 stuks) |
| | JA25 bruin 87114 (10.000 stuks) |
| | JA10 bruin 87115 (20.000 stuks) |
|  | Brads gegalvaniseerd |
| | J15 C/gegalvaniseerd 87117 (5.000 stuks) |
| | J20 C/gegalvaniseerd 87118 (5.000 stuks) |
| | J25 C/gegalvaniseerd 87119 (5.000 stuks) |
| | J30 C/gegalvaniseerd 87120 (5.000 stuks) |
|  | Brads goldlook |
| | J12 goldlook 87121 (10.000 stuks) |
| | J15 goldlook 87122 (10.000 stuks) |
| | J20 goldlook 87123 (10.000 stuks) |
| | J25 goldlook 87124 (5.000 stuks) |
| | J30 goldlook 87125 (5.000 stuks) |
| | J32 goldlook 87126 (5.000 stuks) |

| Union Brads | Artikelnr. |
|---|--|
|  | Brads |
| | JM20 87129 gegalvaniseerd (10.000 stuks) |

| Union nieten | Artikelnr. |
|---|---------------------------------|
|  | Nieten |
| | 0-10 mm 87075 (8.000 stuks) |
| | 0-12 mm 87076 (8.000 stuks) |
| | 0-14 mm 87077 (8.000 stuks) |
| | 0-16 mm 87078 (8.000 stuks) |
| | E-12 mm 87089 (12.000 stuks) |
| | E-15 mm 87090 (8.000 stuks) |
| | E-20 mm 87091 (8.000 stuks) |
| | E-25 mm 87092 (4.000 stuks) |

| Union krammen | Artikelnr. |
|---|--|
|  | Krammen |
| | S-32 CHST HA 87163 (10.000 stuks) |
| | S-38 CHST HA 87164 (10.000 stuks) |
|  | Krammen goldlook |
| | L-25 goldlook 87166 voor Bea 14 tacker (7.500 stuks) |
| | L-32 goldlook 87167 voor Bea 14 tacker (7.500 stuks) |
| | L-38 goldlook 87168 voor Bea 14 tacker (7.500 stuks) |

| Union nagels | Artikelnr. |
|---|---|
|  | Afwerknagels gegalvaniseerd |
| | N-25 mm 87082 (2.500 stuks) |
| | N-30 mm 87083 (2.500 stuks) |
| | N-40 mm 87084 (2.500 stuks) |
|  | T-nagels staal |
| | 2,2x32 VZ/ST staal 87133 (2.000 stuks) |
| | 2,2x38 VZ/ST staal 87134 (1.000 stuks) |
|  | T-nagels verzinkt |
| | 2,2x32 verzinkt 87153 (2.000 stuks) |
| | 2,2x38 verzinkt 87154 (1.000 stuks) |
|  | TL-nagels |
| | 2,5x25 VZ/ST staal 87141 (2.000 stuks) |
| | 2,5x32 VZ/ST staal 87143 (1.000 stuks) |
| | 2,5x38 VZ/ST staal 87144 (1.000 stuks) |
|  | TM-nagels |
| | 1,8x25 VZ/ST staal 87158 (3.000 stuks) |
| | 1,8x32 VZ/ST staal 87159 (1.500 stuks) |

9.2.5 SCHROEVEN





| Festool | Artikelnr. |
|---|--|
|  | Twinbox met 10 bitjes mix in riemhouder 87432 |
| PPC | Artikelnr. |
|  | 32-delige bitset 85419 |
|  | Schroefbit Pozidrive 87242 |
|  | Schroefbit Torx 87243 |
|  | Magnetische bithouder met slot 87246 |
|  | Spaanplaatschroef 200 stuks |
| | 4,0x30 mm / PZ2 87220 |
| | 4,0x30 mm Torx 87227 |
| | 4,0x35 mm / PZ2 87221 |
| | 4,0x35 mm Torx 87228 |
| | 4,0x40 mm / PZ2 87222 |
| | 4,0x40 mm Torx 87229 |
| | 4,0x50 mm / PZ2 87223 |
| | 4,0x50 mm Torx 87230 |
| | 4,0x60 mm Torx 87231 |















| Union | Artikelnr. |
|---|---|
|  | Schroeven (strip) 1.000 stuks |
| | 4,0x30mm PZ2 87184 |
| | 4,0x35mm PZ2 87185 |
| | 4,0x40mm PZ2 87186 |
| | 4,0x45mm PZ2 87187 |
| | 4,0x50mm PZ2 87188 |
|  | Schroeven voor aluminium profielen |
| | RVS 3x16 mm 04004 250 stuks |
| | Zilver 3x16 mm 04001 250 stuks |

9.2.6 BOREN

| Festool | Artikelnr. |
|--|--|
|  | Boorafzuigset D27-BSD 87424 |
|  | Houtboor-Cassette BKS D3-10 CE/W 87426 |
|  | Spiraalboor cassette HSS 3-10/10x Centrotec 87428 |
|  | Cilinderboorset FB D 15-35 CE-Set 88248 |
| Janser | Artikelnr. |
|  | Handboor voor PVC |
| | 4-20 mm 85632 |
| | 16-30,5 mm 85634 |
|  | Handboor set voor PVC 4-20 en 16-30,5 mm 85631 |

9.2.7 MEET- EN AFTEKEN GEREEDSCHAP

| Gann vochtmeters | Artikelnr. |
|---|--|
|  | Houtvocht prikmeter BL compact S 85278 |
|  | Houte n betonvochtmeter Compact B 85279 |
|  | Hout en betonvochtmeter BL Compact B2 85280 |
|  | BL Compact TF 3 85285 |

| Hultafors | Artikelnr. |
|---|--|
|  | Duimstok G59 glasfiber geel 1 meter 4 delen 85509 |
|  | Duimstok glasfiber wit 1 meter 85510 |
|  | Waterpas aluminium |
| | SM 60 cm 85543 |
| | SM 100 cm 85541 |
| | SM 200 cm 85542 |
|  | Rolbandmaat staal |
| | TK 5M 85517 |
| | AP 8M 85518 |
|  | Slaglijn CLP 30 85552 |
|  | Slagsnoerkrijt ultrablauw 400 gr 85551 |
|  | Slagsnoerkrijt rood 360 gr 85555 |
|  | Betonpotlood BEP 30 cm 85546 |
|  | Timmermanspotlood SNP 24 cm 85545 |
|  | Vulpotlood 85624 |
|  | Vulpotlood navulling |
| | Grafiet 85625 |
| | GRY (4 grafiet/ 3 rood/3 geel) 85626 |
| | Wit 85627 |
|  | Kunststof verstekhaak rood 85501 |
|  | Zwaaihaak, rvs, 20 cm 85503 |
|  | Winkelhaak Semi-Professional V 25 S 85504 |

9.2.7 MEET- EN AFTEKEN GEREEDSCHAP (vervolg)

Hultafors *Artikelnr.*

**Instelbare
winkelhaak
QUATTRO 25** 85508



Metric Rafter
Square mini 85500
Square 85514
Square groot 85502

PPC *Artikelnr.*

Uitvulplaatjes 85428
200 stuks

Pajarito *Artikelnr.*

Beton vochtmeter 85292

Woodcap *Artikelnr.*

**Thermo Hygrometer
TH10** 85277



Color Master CM2 85288



**Moisture Master
PM2** 85287

Overig *Artikelnr.*

Fidbox V6 85317



Easylogger 85326
5 stuks



**Vloerverwarming
verklikkers** 85301



**IR-T1 infrarood
pistool thermometer** 85291



Laser afstandsmeter 85290
40 meter



**Liniaal van RVS
bandstaal 2.050 mm** 85337



**Professionele
trapjabloon** 85316



**Professionele
trapspin** 85315



**Trapkant
hoekafschrijver** 85314



Zuignap aluminium 85309
35 kg



Voelmaat 85323
0,05-1,0 mm

9.2.8 LIJMKAMMEN

PPC *Artikelnr.*

Lijmkam zeer fijn

A1 (zeer fijn) 92141



Lijmkam fijn

A2 voor PVC
18 cm breed 92142

A2 voor PVC
25 cm breed 92143

B2 voor tapijt
18 cm breed 92147

F1000 - B8
18 cm breed 92161

F1000 - B8 Extra
25 cm breed 92176

F1250 - B14
18 cm breed 92171

F850 - B3
18 cm breed 92151

F850 - B3 extra
25 cm breed 92175



Lijmkam grof

G1000 - B10
18 cm breed 92162

G1000 - B10
25 cm breed 92177

G1250 - B16
18 cm breed 92172

G1250 - B16
25 cm breed 92178

G850 - B6
18 cm breed 92152



Lijmspatel fijn

F850 - B3
6 cm breed 92148



Lijmspatel grof

G1000 - B10
6 cm breed 92149

9.2.8 LIJMKAMMEN (vervolg)

| Bona | Artikelnr. |
|---|--|
|  | Lijmkam 500F (A3) - 250x150 mm 96756 |
|  | Trowel plus lijmkam voor Quantum 96696 |
| Kerakoll | Artikelnr. |
|  | SLC lijmkam nummer 4 96628 |
| Stauf | Artikelnr. |
|  | Lijmkam |
| | Nr. 1 (A2) 96475 |
| | Nr. 2 96476 |
| | Nr. 3 (B7) 96477 |
| | Nr. 4 (B15) 96478 |
| | Nr. 5 (B9) 96479 |
| | Nr. 8 (B2) 96480 |
| | Nr. 9 (A4) 96481 |
| | Nr. 10 (S1) 96482 |
| | Nr. 11 (TBK S2) 96483 |
| | Nr. 12 96484 |
| | Nr. 14 96485 |

9.2.9 SCHAREN, STANZEN EN MESSEN

| | Artikelnr. |
|---|---|
|  | Afbreekmes |
| | BKP 18A 85566 |
| | Kunststof klein 13 cm 85568 |
| | SFRPB 18A 85577 |
|  | Reserve afbreekmessen |
| | Klein RB BK-9 85569 |
| | 10 stuks |
| | Standaard RB BK-18 85567 |
| | 10 stuks |
| | Standaard SBA9-10 85562 |
|  | Reserve haakmessen UBH 85563 |
| | 10 stuks |
|  | Reserve rechte messen RB UBA-10 85561 |
| | 10 stuks |
|  | Uitschuif Utility URZ mes 85560 |
|  | Delphin mes inclusief houder 85212 |
|  | Pajarito reservemes |
| | 19 mm hoekhaak 85242 |
| | 10 stuks |
|  | 19 mm rond voor PVC 85245 |
| | 10 stuks |
|  | 19 mm trapezium 85246 |
| | 10 stuks |
|  | 19 mm haak 85247 |
| | 10 stuks |
|  | Haakmesjes 85432 |
| | 10 stuks |
|  | Reservemes 130 mm (groot) verstekstans type 715 85131 |
|  | Mes RFR GH 85559 |
|  | Afstekmes 85429 |
|  | Reservemes voor afstekmes 85430 |

| | Artikelnr. |
|---|---|
|  | Verstekschaar Löwe |
| | Met handvat 85111 |
| | Met handvat en hefboom 85113 |
|  | Verstekschaar met oranje handvat 85115 |
|  | Patroon voor profiel knippen 90 graden 85302 |
|  | Patroon voor profiel knippen 45 graden 85303 |
|  | Tapijtschaar RVS 260 mm 85343 |
|  | Poolschaar 85138 |
|  | EDMA Straticut 230 laminaat en PVC knipper - 230 mm 85128 |
|  | Laminaatknipper Edma 899 - tot 32 cm breed 85135 |
|  | Verstekstans Edma 850 - groot mes 85130 |
|  | Vinyl stroken snijder 300 mm 88730 |
|  | PVC strokensnijder 330 mm maximaal 16 mm 88734 |
|  | Reserve mes voor PVC strokenwsnijder 330 mm 88735 |
|  | PVC randensnijder / kantenkoning 85340 |
|  | PVC strokensnijder / strokenkoning 85342 |
|  | Stroknijder voor PVC verstelbaar 38 tot 140 mm 85119 |
|  | Stroknijder voor tapijt 45-100 mm 86001 |



9.2.10 BEITELS

| Hultafors | Artikelnr. |
|---|-------------------------------|
|  | Beitel EDC recht model |
| 10 mm | 85597 |
| 12 mm | 85598 |
| 16 mm | 85599 |
| 18 mm | 85600 |
|  | Beitel zware kwaliteit |
| HDC 20 mm | 85606 |
| HDC 25 mm | 85607 |
| HDC 32 mm | 85608 |
| HDC 40 mm | 85609 |
|  | Beitelset |
| HDC S4, 6-25 | 85604 |
| HDC S4, 12-32 | 85605 |

9.2.11 WALSEN

| | Artikelnr. |
|--|-------------|
|  | Wals |
| 30 kg voor tapijt/linoleum | 85435 |
| 50 kg voor tapijt/linoleum | 85436 |
| 68 kg voor PVC/linoleum | 85437 |

9.2.12 OVERIG

| Aanslagblok | Artikelnr. |
|---|---|
|  | Aanslagblok met handvat 45 cm |
| | 96226 |
|  | Aanslagblok met kleine groef met handvat 45 cm |
| | 96227 |
|  | Aanslagblok met grote groef met handvat 45 cm |
| | 96228 |
| Hultafors | Artikelnr. |
|  | Terugslagvrije hamer |
| STFS voor tapis 1145 gram | 85581 |
| STFS 595 gram | 85582 |
|  | Stalen koevoet |
| 109 25" | 85592 |
| 108 mini | 85617 |
| 108/15" | 85618 |

| Janser | Artikelnr. |
|---|---------------------------|
|  | Gaten stans tapijt |
| 30 mm | 86002 |
| 40 mm | 86003 |
| 50 mm | 86004 |
|  | Zuignap zwart |
| | 85308 |

| Overig | Artikelnr. |
|---|--|
|  | Pluisvrije theedoeken |
| 9 kg | 98889 |
| 10 kg | 98890 |
|  | Katoenen doeken 10 kg |
| | 97355 |
|  | Pluisvrije witte katoenen poetsdoeken 10 kg |
| | 97356 |
|  | Drevel 1 mm staal |
| | 85431 |
|  | Emmer 10 liter wit |
| | 76080 |
|  | Contourenmal |
| | 85328 |
|  | Gatenstans |
| 22 mm voor rozetten | 85587 |
| 27 mm voor rozetten | 85588 |
|  | Verfkrabber extra hard |
| 6 cm driehoek | 92135 |
| 8 cm driehoek | 92136 |
|  | Vellingkantkrabber met houder |
| | 85248 |
|  | Reservemes voor vellingkantkrabber driehoek |
| | 85249 |
|  | Reservemes voor vellingkantkrabber druppel |
| | 85250 |

9.3 PERSOONLIJKE BESCHERMING

9.3.1 ADEMBESCHERMING

| Adembescherming | Artikelnr. |
|---|--|
|  | Stofmasker met uitademventiel FFP2 |
| 10 stuks | 85229 |
|  | Stofmasker met uitademventiel FFP3 |
| 10 stuks | 85238 |
|  | Sundström adembescherming basic pack SR 900 |
| | 92301 |
|  | Sundström voorfilter SR 221 |
| 5 stuks | 92302 |
|  | Sundström P3-stoffilter SR 510 |
| | 92303 |
|  | Sundström Ammoniak filter SR 316 |
| | 92304 |

9.3.2 GEHOORBESCHERMING



| Gehoorbescherming | Artikelnr. |
|---|---|
|  | Hellberg Secure 2 gehoorcap |
| | 99140 |
|  | Hellberg Xstream LD gehoorcap |
| | 99141 |
|  | Zwanenhals-microfoon voor Xstream LD |
| | 99142 |
|  | Hellberg Hygiëneset |
| Secure 1 & 2 | 99143 |
| Elektonica Xstream | 99144 |
|  | Alpine Worksafe oordoppen |
| | 85235 |
|  | Oordoppen |
| 2 stuks | 98985 |
|  | Gehoorbeguel |
| | 98986 |
|  | Herbruikbare oordoppen met koord |
| | 98992 |

9.3.3 HANDBESCHERMING

| Snickers | Artikelnr. |
|--|--|
|  | Werkhandschoenen zwart/grijs |
| | Maat 9/M 92295 |
| | Maat 10/L 92296 |
| | Maat 11/XL 92297 |
| Overig | Artikelnr. |
|  | Chirurghandschoenen blue (anti-allergisch) 200 stuks |
| | Maat L 92305 |
| | Maat XL 92306 |
|  | Witte schildershandschoenen |
| | Maat M 92343 |
| | Maat L 92344 |
| | Maat XL 92345 |
| Kerakoll | Artikelnr. |
|  | SLC Proman handcrème 500 ml |
| | 96660 |

9.3.4 KNIEBESCHERMING

| Fento | Artikelnr. |
|--|---------------------------------------|
|  | Knee Protector Pocket 92288 |
|  | Knee Protector |
| | 200 92291 |
| | 400 92293 |
|  | Knee Protector Original 92289 |
|  | Inlays Fento Original 92290 |
|  | Elastieken voor Knee Protector |
| | 200 / 200 Pro 92292 |
| | 400 92294 |
|  | Fento Board 92307 |

| Snickers | Artikelnr. |
|---|---|
|  | Kniebeschermers ademend 99122 |
|  | Kniebeschermers 9110 99124 |
| | EN 14404 certified |
|  | Kniebeschermers XTR D30 9191 99125 |

| Ultraknee | Artikelnr. |
|---|--|
|  | Hammock 1 kniebeschermers (in de broek) 92285 |
|  | Hammock 2 kniebeschermers 92286 |
|  | Elastieken voor UltraKnee kniebeschermers 92287 |
| | 2 stuks |

| Janser | Artikelnr. |
|---|--|
|  | Knie rolschaatsen 92308 |
| Overig | Artikelnr. |
|  | Kniebeschermers met klitteband (rood) 92277 |
|  | Klitteband voor rode kniebeschermers 92278 |

9.3.5 OVERSCHOENEN

| | Artikelnr. |
|---|------------------------------------|
|  | Over schoentjes blauw 98980 |
| | 100 stuks |

9.4 VERBRUIKSMATERIALEN

Bona *Artikelnr.*



Glittenbandschijf 95366
178 mm voor Bona Edge

Festool diamantschijf *Artikelnr.*



Diamantschijf 87449
DIA THERMO-D130 PREMIUM



Diamantschijf 87452
DIA HARD-D130 PREMIUM



Diamantschijf 87453
DIA HARD-D130-ST



Diamantschijf 87454
DIA ABRASIVE-D130-ST



Diamantschijf 87456
DIA STONE-D130 PREMIUM



Diamantschijf 87457
DIA UNI-D130 PREMIUM



Diamantschijf DIA 88275
HARD-D150



Diamantschijf DIA 88276
ABRASIVE-D150



Diamantschijf DIA 88277
THERMO-D150

Festool borstelkrans *Artikelnr.*



Borstelkrans 88271
BC-RG 150

Festool zool *Artikelnr.*



Adapterzool voor geleiderail ADT-PS 400 87478



Standaard loopzool LAS-PS 400 87481

Festool zool *Artikelnr.*



Noppen loopzool LAS-SOFT-PS 400 87482



Pertinax loopzool LAS-HGW-PS 400 87483



Reservevilt voor loopzool LAS-STF-PS 400 87485



Verstekzool WT-PS 400 87487



Lamellenschuurzool voor RO 90 LSS-STF-RO90 V93/6 87705



Bodemplaat TP-STF-RO90 DX 87710



Schuurzool stickfix SSH-STF-V93/6-H/2 87718



Vlakke schuurzool LS 87805



Sponningprofielzool 90gr LS 87806



Festool steunschijf *Artikelnr.*



Steunschijf ST-STF D90/7 FX-H-HT 87708



Steunschijf ST-STF D90/7 FX-W-HT 87709



Steunschijf ST-STF D 125/8 FX-W-HT 87711



Steunschijf ST-STF D 125/8 FX-SW 87712



Steunschijf M8 zacht HT ST-STF-D150/MJ2-M8 SW 87713



Steunschijf ST-STF D150/MJ2-M8-W-HT 87714



Festool steunschijf *Artikelnr.*



Steunschijf M8 hard ST-STF D150/MJ2-H-HT 87717



Steunschijf ST-STF-D180/0-M14 W 87720



Steunschijf fiberschijven ST-D180/0-M14/2F 87721



Steunschijf ST-D220/48-LHS 2 225 88236



Steunschijf FX hard ST-STF D 150/MJ2-FX-H-HT 87715



Steunschijf FX zacht HT ST-STF D 150/MJ2-FX-W-HTO 87716

Festool frees *Artikelnr.*



Freeskop diamant hard voor RG 80 88013



Freeskop diamant abrasiv voor RG 80 88014



Freeskop diamant abrasiv voor RGP130/AGP125 88006



Freeskop met wietjes "spits" voor RG 80 88016



Freeswiel HW-SZ 35 88267



Freeswiel HW-FZ 35 88268



Frees voor Domino

4 mm 87686
5 mm 87687
6 mm 87688
8 mm 87689



9.4 VERBRUIKSMATERIALEN (vervolg)













| Festool gereedschapkop | | Artikelnr. | Woodboy | | Artikelnr. | WOCA | | Artikelnr. |
|---|--|------------|---|--|------------|---|--|------------|
|  | Gereedschapkop SZ-RG 150 | 88266 |  | Aandrijfplaat 16" + pennetjesrug | 97901 |  | Velvetschijf 150 mm K2000 10 stuks | 97330 |
|  | Gereedschapkop FZ-RG 150 | 88269 |  | Pennetjesrug 16" op buffer | 97902 |  | Steunschijf voor velvetschijf 2 stuks | 97331 |
|  | Gereedschapkop DIA HARD-RG 150 | 88272 |  | Aandrijfschijf 16" + celrubber + velcro | 97903 | Overig | | |
|  | Gereedschapkop DIA ABRASIVE-RG 150 | 88273 |  | Celrubber 16" + snelhechting | 97904 |  | Pinnetjesrug met zwarte gummimousse 16" | 95330 |
|  | Gereedschapkop DIA THERMO-RG 150 | 88274 |  | Siliciumschijf 16" | 97905 |  | Miniwrapper voor inpakfolie | 87001 |
| Festool splinterbescherming | | | Union | | | Reiniging | | |
| Artikelnr. | | | Artikelnr. | | | Artikelnr. | | |
| Anti-splinterstrip | | | Tackerolie | | | PPC Universele reinigingsdoekjes | | |
|  | FS-SP 1400/T | 87547 |  | 20 ml | 87169 |  | 90 stuks | 92209 |
|  | FS-SP 5000/T | 87548 |  | 500 ml | 87170 |  | 150 stuks | 98995 |
|  | Anti-slipstrip FS-HU 10m | 87549 |  | Slagpen voor tacker 1AH/JA-30 | 87067 |  | 500 ml | 96660 |
|  | Splinterbescherming SP-PS/PSB 300/20 | 87508 |  | Slagpen voor JA-tacker (inslagdiepte circa 2 mm) | 87174 | | | |
|  | Splinterbescherming SP-TS 55/5 (TS 55/TS 75) | 87539 |  | Kunststof beschermneus voor JA-tacker | 87173 | | | |
|  | Splinterbescherming SP/10 (CS 50) | 87579 |  | Union bit 9M/MGS-55BIT-PZ2 | 87181 | | | |
|  | Splinterbescherming SP/10 (CS 70) | 87585 | | | | | | |

9.4 VERBRUIKSMATERIALEN (vervolg)

| Stofzuigerzakken | Artikelnr. | Stofzuigerzakken | Artikelnr. |
|---|---|---|--|
|  | Longopac navulstofzak BonaDCS/HTC GL25TD 4x20m¹ 95342 |  | Longlife filterzak FIS-CTL MIDI 87894 5 stuks |
|  | Bona stofzak met rits voor Edge 95332 |  | Sluiting voor Longlife filterzak CT MINI/MIDI 87948 |
|  | Selfclean filterzak voor CTL SYS 87862 5 stuks |  | Stofzakken voor Numatic NED 900-A 95742 10 stuks |
|  | Longlife filterzak voor CTL SYS 87863 |  | Stofzak Hummel 95729 |
|  | Selfclean filterzak FIS-CT 17 88023 5 stuks | Filters | |
|  | Selfclean filterzak CT22 87896 5 stuks |  | Hoofdfilter HF-CT MINI/MIDI-2 87953 |
|  | Longlife filterzak FIS-CT 22 87869 |  | Hoofdfilter HF-CT 26/36 87900 |
|  | Selfclean filterzak CT26 87897 5 stuks |  | Hoofdfilter CTL SYS 87864 |
|  | Longlife filterzak FIS-CT 26 87902 |  | Natfilter NF-CT 26/36 87901 |
|  | Selfclean filterzak CT36 87898 5 stuks | | |
|  | Longlife filterzak FIS-CT 36 87879 | | |
|  | Sluiting voor Longlife filterzak CT/CTL 26/36 87910 | | |
|  | Selfclean filterzak FIS-CT MINI/MIDI-2 87954 5 stuks | | |
|  | Longlife filterzak FIS-CT MINI/MIDI-2 87955 | | |
|  | Selfclean filterzak FIS-CTL MIDI 87895 5 stuks | | |

9.5 MAGAZIJN EN BUS

9.5.1 OPBERGEN

| Festool | Artikelnr. |
|---|--|
|  | Systainer³ SYS3 M 112 88158 |
|  | SYS3 M 187 88159 |
|  | SYS3 M 237 88160 |
|  | SYS3 M 337 88161 |
|  | SYS3 HWZ M 337 88221 |
|  | SYS3 M 437 88162 |
|  | SYS3 L 237 88163 |
|  | SYS3 XXL 237 88193 |
|  | SYS3 XXL 337 88194 |
|  | Systainer³ SYS3 ORG M 89 88222 |
| | SYS3 ORG M 89 22xESB 88223 |
| | SYS3 ORG M 6xESB 88224 |
| | SYS3 ORG L 89 88225 |
| | SYS3 ORG L 89 20xESB 88226 |
| | SYS3 ORG L 89 10xESB 88227 |
|  | Systainer PowerHub 2500W 87418 |
|  | TOPROCK-Bluetooth-Player SYS3 BT20 M 137 88244 |
|  | Kitkoker Inzet TZE-KT SYS3 M 88166 |

| Festool | Artikelnr. |
|---|--|
|  | Uittreklade SYS-AZ-MW 1000 87442 |
|  | Uittreklade SYS-AZ 87495 |
|  | Systainer³ Toolbox M TB M 137 88260 |
|  | Accessoire Systainer Fs/2 SYS3 M 137 FS/2-Set 88344 |
|  | Bodem- Schuimrubber SE-BP SYS3 XXL 88220 |

9.5.2 OVERIG

| Festool | Artikelnr. |
|---|--|
|  | Systainer steekwagen 87930 |
|  | Systainer-trolley SYS-RB 88164 |
|  | Mobiële werkplaats MW 1000 basic 87441 |
|  | Mobiële werkplaats MW 1000 set 87440 |

| Overig | Artikelnr. |
|---|--|
|  | Plateauwagen 380 kg 85426 |
|  | Transport dolly 150 kg 85427 |
|  | Bezem hard (zonder steel) 92279 |
|  | Bezem zacht (zonder steel) 92280 |

| Overig | Artikelnr. |
|---|--|
|  | Bezemsteel 170 cm (Ø 2,8 cm) 92194 |
|  | Stoffer en blik kunststof 92282 |
|  | Verbandtrommel universeel 92355 |
|  | Papierrolhouder voor achter in de bus 98996 |
|  | Rol papier 120 meter 12 rollen 98997 |
| Verlengkabel | Artikelnr. |

| | |
|--|--|
|  | Soepele PUR verlengkabel 3x2,5mm ² oranje |
| 15 meter | 95373 |
| 10 meter | 95374 |

9.6 WERKKLEDING EN SCHOENEN

9.6.1 SCHOENEN

Janser *Artikelnr.***Werkschoen parketteur nubuckleer**

| | |
|----|-------|
| 40 | 99780 |
| 41 | 99781 |
| 42 | 99782 |
| 43 | 99783 |
| 44 | 99784 |
| 45 | 99785 |
| 46 | 99786 |
| 47 | 99787 |

**Reserve inlegzool**

| | |
|----|-------|
| 40 | 99788 |
| 41 | 99789 |
| 42 | 99790 |
| 43 | 99791 |
| 44 | 99792 |
| 45 | 99793 |
| 46 | 99794 |
| 47 | 99795 |

**Beschermneus voor Janser werkschoen**Bickz *Artikelnr.***Werkschoen laag BICKZ 728 S3 grijs nubuck**

| | |
|----|-------|
| 41 | 99841 |
| 42 | 99842 |
| 43 | 99843 |
| 44 | 99844 |
| 45 | 99845 |
| 46 | 99846 |

Solid Gear *Artikelnr.***Werkschoen laag Solid Gear Revolution Infinity**

| | |
|----|-------|
| 41 | 99470 |
| 42 | 99471 |
| 43 | 99472 |
| 44 | 99473 |
| 45 | 99474 |
| 46 | 99475 |

Lightech *Artikelnr.***Werkschoen laag Distance zwart**

| | |
|----|-------|
| 41 | 99750 |
| 42 | 99751 |
| 43 | 99752 |
| 44 | 99753 |
| 45 | 99754 |
| 46 | 99755 |

9.6.2 BROEKEN

Snickers *Artikelnr.***FlexiWork werkshorts + holsterzakken zwart**

| | |
|----|-------|
| 44 | 99088 |
| 46 | 99089 |
| 48 | 99090 |
| 50 | 99091 |
| 52 | 99092 |
| 54 | 99093 |
| 56 | 99094 |
| 58 | 99095 |

**Rip-Stop short + holsterzakken zwart**

| | |
|----|-------|
| 44 | 99112 |
| 46 | 99113 |
| 48 | 99114 |
| 52 | 99116 |
| 54 | 99117 |
| 56 | 99118 |
| 58 | 99119 |

Snickers *Artikelnr.***Rip-stop vloerleggersbroek donkergrijs**

| | |
|-----|-------|
| 42 | 99001 |
| 44 | 99002 |
| 46 | 99003 |
| 48 | 99004 |
| 50 | 99005 |
| 52 | 99006 |
| 54 | 99007 |
| 56 | 99008 |
| 58 | 99009 |
| 144 | 99032 |
| 146 | 99033 |
| 148 | 99034 |
| 150 | 99035 |
| 152 | 99036 |
| 154 | 99037 |
| 244 | 99042 |
| 252 | 99046 |
| 254 | 99047 |

**Werkbroek canvas/cordura donkergrijs**

| | |
|----|-------|
| 42 | 99201 |
| 44 | 99202 |
| 46 | 99203 |
| 48 | 99204 |
| 50 | 99205 |
| 52 | 99206 |
| 54 | 99207 |
| 56 | 99208 |

**Werkbroek canvas/cordura donkergrijs met holsterzakken**

| | |
|----|-------|
| 50 | 99275 |
| 52 | 99276 |

**Werkbroek gemêleerd blauw**

| | |
|-----|-------|
| 42 | 99010 |
| 44 | 99011 |
| 46 | 99012 |
| 48 | 99013 |
| 50 | 99014 |
| 52 | 99015 |
| 54 | 99016 |
| 56 | 99017 |
| 146 | 99018 |
| 148 | 99019 |
| 150 | 99020 |

9.6.2 BROEKEN (vervolg)

| Snickers | Artikelnr. |
|---|---|
|  | Werkbroek gemêleerd grijs/zwart |
| | 42 99301 |
| | 44 99302 |
| | 46 99303 |
| | 48 99304 |
| | 50 99305 |
| | 52 99306 |
| | 54 99307 |
| | 146 99333 |
| | 148 99334 |
| 150 99335 | |
|  | Werkbroek gemêleerd zwart |
| | 42 99021 |
| | 44 99022 |
| | 46 99023 |
| | 48 99024 |
| | 50 99025 |
| | 52 99026 |
| | 54 99027 |
| | 146 99028 |
| | 148 99029 |
| 150 99030 | |
| 152 99031 | |
|  | Werkbroek met holsterzakken Rip-stop blauw/zwart |
| | 46 99072 |
| | 48 99073 |
| | 50 99074 |
| 52 99075 | |
|  | Werkbroek met holsterzakken Rip-stop grijs/zwart |
| | 46 99064 |
| | 48 99065 |
| | 50 99066 |
| | 52 99067 |
| | 146 99068 |
| | 148 99069 |
| 150 99070 | |
| 152 99071 | |
|  | Werkbroek met holsterzakken Rip-stop zwart/zwart |
| | 46 99060 |
| | 48 99061 |
| | 50 99062 |
| 52 99063 | |

| Snickers | Artikelnr. | |
|---|--|--------------------------------|
|  | Werkbroek Stretch Blauw/Zwart | |
| | 44 99043 | |
| | 46 99049 | |
| | 48 99050 | |
| | 50 99051 | |
| | 52 99052 | |
| | 54 99053 | |
| | 56 99054 | |
| | 58 99055 | |
| | 146 99056 | |
| | 148 99057 | |
| | 150 99058 | |
| | 152 99059 | |
| |  | Werkbroek Stretch Zwart |
| | | 44 99096 |
| 46 99097 | | |
| 48 99098 | | |
| 50 99099 | | |
| 52 99100 | | |
| 54 99101 | | |
| 56 99102 | | |
| 58 99103 | | |
| 146 99038 | | |
| 148 99039 | | |
| 150 99040 | | |
| 152 99041 | | |
|  | Riem katoen/lycra zwart 99120 | |

9.6.3 JASSEN EN TRUIEN

| Snickers | Artikelnr. |
|---|--|
|  | Hoodie blauw |
| | S 99569 |
| | M 99570 |
| | L 99571 |
| | XL 99572 |
| | XXL 99573 |
| XXXL 99574 | |
|  | Hoodie grijs |
| | S 99581 |
| | M 99582 |
| | L 99583 |
| | XL 99584 |
| | XXL 99585 |
| XXXL 99586 | |
|  | Hoodie zwart |
| | S 99575 |
| | M 99576 |
| | L 99577 |
| | XL 99578 |
| | XXL 99579 |
| XXXL 99580 | |
|  | Sweater met rits zwart |
| | XS 99430 |
| | S 99431 |
| | M 99432 |
| | L 99433 |
| | XL 99434 |
| XXL 99435 | |
| XXXL 99436 | |
|  | Logo hoodie met rits donker blauw |
| | S 99597 |
| | M 99598 |
| | L 99599 |
| | XL 99600 |
| XXL 99601 | |
|  | Logo hoodie met rits grijs |
| | S 99592 |
| | M 99593 |
| | L 99594 |
| | XL 99595 |
| XXL 99596 | |
|  | Logo hoodie met rits zwart |
| | S 99587 |
| | M 99588 |
| | L 99589 |
| | XL 99590 |
| XXL 99591 | |

9.6.3 JASSEN EN TRUIEN (vervolg)

| Snickers | | Artikelnr. |
|---|---------------------------------------|------------|
|  | FlexiWork fleece hoodie grijs | |
| | S | 99607 |
| | M | 99608 |
| | L | 99609 |
| | XL | 99610 |
| | XXL | 99611 |
|  | FlexiWork fleece hoodie zwart | |
| | S | 99602 |
| | M | 99603 |
| | L | 99604 |
| | XL | 99605 |
| | XXL | 99606 |
|  | Soft shell jacket zwart | |
| | M | 99560 |
| | L | 99561 |
| | XL | 99562 |
|  | Soft shell jacket donker blauw | |
| | L | 99567 |
| | XL | 99568 |

9.6.4 SHIRTS

| Snickers | | Artikelnr. |
|---|--------------------------------|------------|
|  | T-shirt blauw | |
| | S | 99375 |
| | M | 99376 |
| | L | 99377 |
| | XL | 99378 |
| | XXL | 99379 |
| | XXXL | 99380 |
|  | T-shirt wit | |
| | S | 99381 |
| | M | 99382 |
| | L | 99383 |
| | XL | 99384 |
| | XXL | 99385 |
| | XXXL | 99386 |
|  | T-shirt grijs | |
| | S | 99391 |
| | M | 99392 |
| | L | 99393 |
| | XL | 99394 |
| | XXL | 99395 |
| | XXXL | 99396 |
|  | T-shirt zwart | |
| | S | 99401 |
| | M | 99402 |
| | L | 99403 |
| | XL | 99404 |
| | XXL | 99405 |
| | XXXL | 99406 |
|  | Classic poloshirt zwart | |
| | XS | 99410 |
| | S | 99411 |
| | M | 99412 |
| | L | 99413 |
| | XL | 99414 |
| | XXL | 99415 |
| XXXL | 99416 | |

10. TRAPRENOVATIE

| | | |
|------|---------------------------------|-----|
| 10.1 | TRENOVO | 182 |
| 10.2 | MEXFORM | 184 |
| 10.3 | NATURAL WOOD | 188 |
| 10.4 | WARM BY BAUWERK | 189 |
| 10.5 | TRAPNEUSPROFIELEN | 190 |
| 10.6 | ANTISLIP | 191 |
| 10.7 | TRAPLEUNINGEN EN LEUNINGHOUDERS | 192 |
| 10.8 | GEREEDSCHAPPEN | 194 |
| 10.9 | FOLDERS EN DISPLAYS | 195 |

10.1 TRENOVO

Laminaat
trapredeUitlooptrede
UnificDubbel
stootbord

| Formaat (cm) | | 92x32 | 115x32 | 115x50 | 138x50 | 160x50 | 278x50 | 138x13,2 | 278x13,2 | 92 | 115 | 138 | 160 |
|-----------------------|----------------------|-------|--------|--------|--------|--------|--------|----------|----------|-------|-------|-------|-------|
| Homeline laminaat CPL | Beton | 70475 | 70476 | 70477 | 70478 | 70495 | 70479 | 70484 | 70485 | 70480 | 70493 | 70481 | 70496 |
| | Basalt donker PRO | 70450 | 70451 | 70452 | 70453 | 70470 | 70454 | 70459 | 70460 | 70455 | 70468 | 70456 | 70471 |
| | Grafiet | 70500 | 70501 | 70502 | 70503 | 70520 | 70504 | 70509 | 70510 | 70505 | 70518 | 70506 | 70521 |
| | Hoogland eiken | 69951 | 69952 | 69942 | 69943 | 69930 | 69944 | 69949 | 69920 | 69941 | 69962 | 69950 | 69932 |
| | Provençaals eiken | 69741 | 69742 | 69732 | 69733 | 69752 | 69734 | 69739 | 69740 | 69731 | 69746 | 69738 | 69756 |
| | Toscaans eiken | 69831 | 69832 | 69822 | 69823 | 69846 | 69824 | 69829 | 69830 | 69821 | 69840 | 69828 | 69842 |
| Homeline solution PP | Beton antraciet PRO | 71650 | 71651 | 71652 | 71653 | 71671 | 71654 | 71659 | 71660 | 71655 | 71669 | 71656 | 71672 |
| | Beton grijs PRO | 71675 | 71676 | 71677 | 71678 | 71696 | 71679 | 71684 | 71685 | 71680 | 71694 | 71681 | 71697 |
| | Loft grijs | 71750 | 71751 | 71752 | 71753 | 71771 | 71754 | 71759 | 71760 | 71755 | 71769 | 71756 | 71772 |
| | Loft licht | 71775 | 71776 | 71777 | 71778 | 71796 | 71779 | 71784 | 71785 | 71780 | 71794 | 71781 | 71797 |
| | Landhuis eiken | 71490 | 71491 | 71492 | 71493 | 71519 | 71494 | 71503 | 71504 | 71514 | 71489 | 71515 | 71544 |
| | Kasteel eiken | 71460 | 71461 | 71462 | 71463 | 71457 | 71464 | 71473 | 71474 | 71484 | 71487 | 71485 | 71455 |
| | Zand eiken | 71401 | 71402 | 71403 | 71404 | 71388 | 71405 | 71414 | 71415 | 71400 | 71425 | 71399 | 71387 |
| | Tirols eiken | 71825 | 71826 | 71827 | 71828 | 71846 | 71829 | 71834 | 71835 | 71830 | 71844 | 71831 | 71847 |
| | Gebleekt eiken | 71725 | 71726 | 71727 | 71728 | 71746 | 71729 | 71734 | 71735 | 71730 | 71744 | 71731 | 71747 |
| | Noors eiken | 71800 | 71801 | 71802 | 71803 | 71821 | 71804 | 71809 | 71810 | 71805 | 71819 | 71806 | 71822 |
| | Fjord eiken | 71430 | 71431 | 71432 | 71433 | 71391 | 71434 | 71443 | 71444 | 71397 | 71394 | 71396 | 71390 |
| | Donker gerookt eiken | 71700 | 71701 | 71702 | 71703 | 71721 | 71704 | 71709 | 71710 | 71705 | 71719 | 71706 | 71722 |



DUBBEL STOOTBORD FOLIE

Vanwege de verschillende kleur per kant,
zijn deze stootborden multi-inzetbaar
8 mm dik

| Formaat (cm) | 92x40 | 115x40 | 138x40 | 160x40 |
|-----------------|-------|--------|--------|--------|
| RAL9003/RAL9016 | 71607 | 71608 | 71609 | 71599 |
| RAL9010/RAL7043 | 71617 | 71618 | 71619 | 71598 |
| RAL9005/RAL7042 | 71627 | 71628 | 71629 | 71597 |

Trenovo universele producten

Afmeting

Artikelnr.



Stootbord RVS geborsteld
9 mm dik

92x18 cm 70340
138x18 cm 70341
280x18 cm 70342



Hoekprofiel wit

8x20 mm 70271



U-afdekprofiel wit

8x68 mm 70360
8x83 mm 70361



Stabiliseringsprofiel
2 mm staal

45x23 mm 70900



**Montageset voor
stabiliseringsprofiel**

70901









KITTEN OP KLEUR

Bijpassende kleuren voor het afkitten van de trap
vind je in hoofdstuk 3: Lijmen & Kit > 3.8 Kitten op kleur
of kijk in onze webshop

10.1 TRENOVO (vervolg)

| | | Hoekprofiel | Hoekprofiel onderzijde | LED-hoekprofiel | U-afdekprofiel | Zijde-afdekking | Kant-afwerking | Trapweng | Laminaat (antslip R10) | Losse neus* | | |
|------------------------------|----------------------------|-------------|------------------------|-----------------|----------------|-----------------|----------------|--------------|------------------------|---------------|-----------------|--------------|
| Formaat (cm) | | 8x20 | 8x100 | 22x45 | 22x45 | 8x68 | 8x83 | 10x70 | 1,3x7 | 40x280 | 19x128,7 | 135x6 |
| Homeline laminaat CPL | Beton | 70489 | 70494 | 70487 | 70488 | 70490 | 70491 | 70492 | | 70482 | 70486 | 70458 |
| | Basalt donker PRO | 70464 | 70469 | 70462 | 70463 | 70465 | 70466 | 70467 | | 70457 | 70461 | 70483 |
| | Grafiet | 70514 | 70519 | 70512 | 70513 | 70515 | 70516 | 70517 | | 70507 | 70511 | 70508 |
| | Hoogland eiken | 69964 | | 69965 | 69971 | 69967 | 69954 | 69968 | | 69969 | 69980 | 69960 |
| | Provencaals eiken | 69754 | 69750 | 69755 | 69761 | 69757 | 69744 | 69758 | | 69759 | 69747 | 69745 |
| | Toscaans eiken | 69844 | 69851 | 69845 | 69836 | 69847 | 69834 | 69848 | | 69849 | 69837 | 69835 |
| Homeline solution PP | Beton antraciet PRO | 71664 | 71670 | 71662 | 71663 | 71665 | 71666 | 71667 | 71668 | 71657 | 71674 | 71658 |
| | Beton grijs PRO | 71689 | 71695 | 71687 | 71688 | 71690 | 71691 | 71692 | 71693 | 71682 | 71699 | 71683 |
| | Loft grijs | 71764 | 71770 | 71762 | 71763 | 71765 | 71766 | 71767 | 71768 | 71757 | 71761 | 71758 |
| | Loft licht | 71789 | 71795 | 71787 | 71788 | 71790 | 71791 | 71792 | 71793 | 71782 | 71786 | 71783 |
| | Landhuis eiken | 71508 | 71517 | 71506 | 71518 | 71509 | 71510 | 71511 | 71513 | | 71505 | 71516 |
| | Kasteel eiken | 71478 | 71488 | 71476 | 71459 | 71479 | 71480 | 71481 | 71483 | 71468 | 71475 | 71486 |
| | Zand eiken | 71419 | 71427 | 71417 | 71389 | 71420 | 71421 | 71422 | 71424 | 71409 | 71416 | 71398 |
| | Tirols eiken | 71839 | 71845 | 71837 | 71838 | 71840 | 71841 | 71842 | 71843 | 71832 | 71849 | 71833 |
| | Gebleet eiken | 71739 | 71745 | 71737 | 71738 | 71740 | 71741 | 71742 | 71743 | 71732 | 71749 | 71733 |
| | Noors eiken | 71814 | 71820 | 71812 | 71813 | 71815 | 71816 | 71817 | 71818 | 71807 | 71811 | 71808 |
| | Fjord eiken | 71448 | 71393 | 71446 | 71392 | 71449 | 71450 | 71451 | 71454 | 71438 | 71445 | 71395 |
| Donker gerookt eiken | 71714 | 71720 | 71712 | 71713 | 71715 | 71716 | 71717 | 71718 | 71707 | 71711 | 71708 | |

| Afwerkprofielen | Afmeting/lengte | Kleur | Artikelnr. | Trenovo LED | Artikelnr. | |
|---|---|--------|------------|---|-----------------------------|-------|
|  | *Je bestelt de neus en het trapuitloopprofiel los. Zo kun je alle kleuren met elkaar combineren. | | |  | 70944 | |
| | Trapuitloopprofiel | 135 cm | Zilver | | | 65360 |
| | 26 mm voor | 135 cm | RVS | | | 65362 |
| | losse neus | 135 cm | Zwart | | | 65361 |
| | | 300 cm | Zilver | | | 65357 |
| | | 300 cm | RVS | | | 65359 |
| | 300 cm | Zwart | 65358 | | | |
|  | | | | TR Losse LED strook wit 22,5 cm 1,8W | 70944 | |
| | | | | TR Losse LED strook warmwit 22,5 cm 1,8W | 70943 | |
| | | | | TR LED lamp vierkant 70x70 mm RVS 0,5W | 70945 | |
| | | | | TR LED verlengkabel | 50 cm 70942 100 cm 70941 | |
| | | | | | | |
| Trenovo LED | | | | Artikelnr. | | |
|  | TR LED voeding 30 Watt (2 meter snoer voor+na voeding) | | | 70940 | | |
|  | TR LED dimmer + afstandsbediening | | | 70947 | | |
|  | TR LED draadloze bewegingssensor | | | 70946 | | |

10.2 MEXFORM

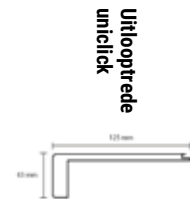
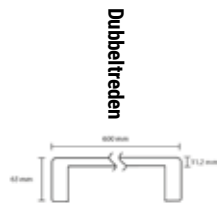

| Formaat (cm) | 90x61 | 121x61 | 136x61 | 181x61 | 364x61 | 90x30 | 121x30 | 136x30 | 90x12,5 | 121x12,5 | 136x12,5 | 181x12,5 |
|------------------------------|-------|--------|--------|--------|--------|-------|--------|--------|---------|----------|----------|----------|
| Cascina grenen | 73461 | 73462 | 73463 | 73464 | 73465 | 73466 | 73467 | 73468 | 73483 | 73484 | 73485 | 73486 |
| Monticiano eik natuur | 74129 | 74130 | 74131 | 74132 | 74133 | 74134 | 74135 | 74136 | 74151 | 74152 | 74153 | 74154 |
| Hickory masonic natuur | 73719 | 73720 | 73721 | 73722 | 73723 | 73724 | 73725 | 73726 | 73741 | 73742 | 73743 | 73744 |
| Orleans eik zand | 73418 | 73419 | 73420 | 73421 | 73422 | 73423 | 73424 | 73425 | 73440 | 73441 | 73442 | 73443 |
| Bussoleno eik grijs | 74041 | 74042 | 74043 | 74044 | 74045 | 74046 | 74047 | 74048 | 74063 | 74064 | 74065 | 74066 |
| Gladstone eik grijs | 73633 | 73634 | 73635 | 73636 | 73637 | 73638 | 73639 | 73640 | 73655 | 73656 | 73657 | 73658 |
| Jackson den | 73504 | 73505 | 73506 | 73507 | 73508 | 73509 | 73510 | 73511 | 73526 | 73527 | 73528 | 73529 |
| Halifax eik tabak | 73590 | 73591 | 73592 | 73593 | 73594 | 73595 | 73596 | 73597 | 73612 | 73613 | 73614 | 73615 |
| Giaveno warm noten | 74085 | 74086 | 74087 | 74088 | 74089 | 74090 | 74091 | 74092 | 74107 | 74108 | 74109 | 74110 |
| Urbino kasteel eik antraciet | 74173 | 74174 | 74175 | 74176 | 74177 | 74178 | 74179 | 74180 | 74195 | 74196 | 74197 | 74198 |
| FineLine metallic | 73934 | 73935 | 73936 | 73937 | 73938 | 73939 | 73940 | 73941 | 73956 | 73957 | 73958 | 73959 |
| Vesuvius zwart houtnerf | 74217 | 74218 | 74219 | 74220 | 74221 | 74222 | 74223 | 74224 | 74239 | 74240 | 74241 | 74242 |
| Cefalu | 73848 | 73849 | 73850 | 73851 | 73852 | 73853 | 73854 | 73855 | 73870 | 73871 | 73872 | 73873 |
| Licht beton | 73289 | 73290 | 73291 | 73292 | 73293 | 73294 | 73295 | 73296 | 73311 | 73312 | 73313 | 73314 |
| Beton | 73332 | 73333 | 73334 | 73335 | 73336 | 73337 | 73338 | 73339 | 73354 | 73355 | 73356 | 73357 |
| Leisteen | 73762 | 73763 | 73764 | 73765 | 73766 | 73767 | 73768 | 73769 | 73784 | 73785 | 73786 | 73787 |
| Marmer | 73805 | 73806 | 73807 | 73808 | 73809 | 73810 | 73811 | 73812 | 73827 | 73828 | 73829 | 73830 |



DUBBEL STOOTBORD FOLIE

Vanwege de verschillende kleur per kant, zijn deze stootborden multi-inzetbaar 8 mm dik

| Formaat (cm) | 92x40 | 115x40 | 138x40 | 160x40 | |
|-----------------|-------|--------|--------|--------|-------|
| RAL9003/RAL9016 | | 71607 | 71608 | 71609 | 71599 |
| RAL9010/RAL7043 | | 71617 | 71618 | 71619 | 71598 |
| RAL9005/RAL7042 | | 71627 | 71628 | 71629 | 71597 |

10.2 MEXFORM (vervolg)



| Formaat (cm) | 90x5,7 | 121x5,7 | 136x5,7 | 181x5,7 | 90x5,7 | 121x5,7 | 136x5,7 | 181x5,7 | 90x5,7 | 121x5,7 | 136x5,7 | 181x5,7 |
|------------------------------|--------|---------|---------|---------|--------|---------|---------|---------|--------|---------|---------|---------|
| Cascina grenen | 73471 | 73472 | 73473 | 73474 | 73475 | 73476 | 73477 | 73478 | 73479 | 73480 | 73481 | 73482 |
| Monticiano eik natuur | 74139 | 74140 | 74141 | 74142 | 74143 | 74144 | 74145 | 74146 | 74147 | 74148 | 74149 | 74150 |
| Hickory masonic natuur | 73729 | 73730 | 73731 | 73732 | 73733 | 73734 | 73735 | 73736 | 73737 | 73738 | 73739 | 73740 |
| Orleans eik zand | 73428 | 73429 | 73430 | 73431 | 73432 | 73433 | 73434 | 73435 | 73436 | 73437 | 73438 | 73439 |
| Bussoleno eik grijs | 74051 | 74052 | 74053 | 74054 | 74055 | 74056 | 74057 | 74058 | 74059 | 74060 | 74061 | 74062 |
| Gladstone eik grijs | 73643 | 73644 | 73645 | 73646 | 73647 | 73648 | 73649 | 73650 | 73651 | 73652 | 73653 | 73654 |
| Jackson den | 73514 | 73515 | 73516 | 73517 | 73518 | 73519 | 73520 | 73521 | 73522 | 73523 | 73524 | 73525 |
| Halifax eik tabak | 73600 | 73601 | 73602 | 73603 | 73604 | 73605 | 73606 | 73607 | 73608 | 73609 | 73610 | 73611 |
| Giaveno warm noten | 74095 | 74096 | 74097 | 74098 | 74099 | 74100 | 74101 | 74102 | 74103 | 74104 | 74105 | 74106 |
| Urbino kasteel eik antraciet | 74183 | 74184 | 74185 | 74186 | 74187 | 74188 | 74189 | 74190 | 74191 | 74192 | 74193 | 74194 |
| Fineline metallic | 73944 | 73945 | 73946 | 73947 | 73948 | 73949 | 73950 | 73951 | 73952 | 73953 | 73954 | 73955 |
| Vesuvius zwart houtnerf | 74227 | 74228 | 74229 | 74230 | 74231 | 74232 | 74233 | 74234 | 74235 | 74236 | 74237 | 74238 |
| Cefalu | 73858 | 73859 | 73860 | 73861 | 73862 | 73863 | 73864 | 73865 | 73866 | 73867 | 73868 | 73869 |
| Licht beton | 73299 | 73300 | 73301 | 73302 | 73303 | 73304 | 73305 | 73306 | 73307 | 73308 | 73309 | 73310 |
| Beton | 73342 | 73343 | 73344 | 73345 | 73346 | 73347 | 73348 | 73349 | 73350 | 73351 | 73352 | 73353 |
| Leisteen | 73772 | 73773 | 73774 | 73775 | 73776 | 73777 | 73778 | 73779 | 73780 | 73781 | 73782 | 73783 |
| Marmar | 73815 | 73816 | 73817 | 73818 | 73819 | 73820 | 73821 | 73822 | 73823 | 73824 | 73825 | 73826 |



| MexForm LED | Artikelnr. |
|-------------|------------|
|-------------|------------|

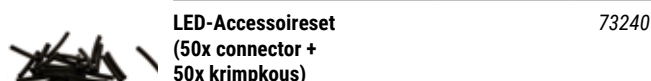

| | | |
|--|--|-------|
| LED-Accessoireset (50x connector + 50x krimpkous) | | 73240 |
|--|--|-------|



| | | |
|--|--------|-------|
| Verlengkabel (inclusief losse female stekker) | 50 cm | 73241 |
| | 200 cm | 73242 |



| | | |
|--|--|-------|
| Voeding 12v met dimmer en afstandsbediening | | 73243 |
|--|--|-------|



| | | |
|--|------|-------|
| MexForm LED-strip voor onderlat | Warm | 73244 |
| | Koud | 73245 |

TIP!

KITTEN OP KLEUR
Bijpassende kleuren voor het afkitten van de trap vind je in hoofdstuk 3: Lijmen & Kit > 3.8 Kitten op kleur of kijk in onze webshop



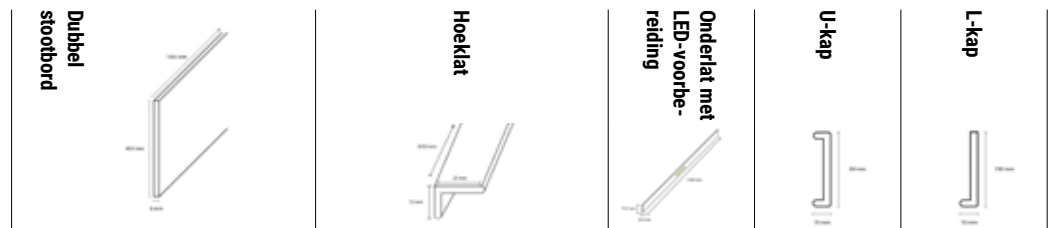

10.2 MEXFORM (vervolg)



| Formaat (cm) | | 90x40 | 136x40 | 181x40 | 12x22 mm | 22x22 mm | 5,55x136 | 69x10 mm | 100x10 mm |
|------------------------------|--|-------|--------|--------|----------|----------|----------|----------|-----------|
| Cascina grenen | | 73487 | 73488 | 73489 | 73496 | 73497 | 73499 | 73494 | 73495 |
| Monticiano eik natuur | | 74155 | 74156 | 74157 | 74164 | 74165 | 74166 | 74162 | 74163 |
| Hickory masonic natuur | | 73745 | 73746 | 73747 | 73754 | 73755 | 73757 | 73752 | 73753 |
| Orleans eik zand | | 73444 | 73445 | 73446 | 73453 | 73454 | 73456 | 73451 | 73452 |
| Bussoleno eik grijs | | 74067 | 74068 | 74069 | 74076 | 74077 | 74078 | 74077 | 74075 |
| Gladstone eik grijs | | 73659 | 73660 | 73661 | 73668 | 73669 | 73671 | 73666 | 73667 |
| Jackson den | | 73530 | 73531 | 73532 | 73539 | 73540 | 73542 | 73537 | 73538 |
| Halifax eik tabak | | 73616 | 73617 | 73618 | 73625 | 73626 | 73628 | 73623 | 73624 |
| Giaveno warm noten | | 74111 | 74112 | 74113 | 74120 | 74121 | 74122 | 74118 | 74119 |
| Urbino kasteel eik antraciet | | 74199 | 74200 | 74201 | 74208 | 74209 | 74210 | 74206 | 74207 |
| FineLine metallic | | 73960 | 73961 | 73962 | 73969 | 73970 | 73972 | 73967 | 73968 |
| Vesuvius zwart houtnerf | | 74243 | 74244 | 74245 | 74252 | 74253 | 74254 | 74250 | 74251 |
| Cefalu | | 73874 | 73875 | 73876 | 73883 | 73884 | 73886 | 73881 | 73882 |
| Licht beton | | 73315 | 73316 | 73317 | 73324 | 73325 | 73327 | 73322 | 73323 |
| Beton | | 73358 | 73359 | 73360 | 73367 | 73368 | 73370 | 73365 | 73366 |
| Leisteen | | 73788 | 73789 | 73790 | 73797 | 73798 | 73800 | 73795 | 73796 |
| Marmer | | 73831 | 73832 | 73833 | 73840 | 73841 | 73843 | 73838 | 73839 |
| Oester | | 74001 | 74002 | 74003 | 74007 | 74008 | | 74005 | 74006 |
| Platina wit | | 73993 | 73994 | 73995 | 73999 | 74000 | | 73997 | 73998 |
| Grafietgrijs | | 73989 | 73990 | 73991 | | | | | |
| Donker taupe | | 73985 | 73986 | 73987 | | | | | |
| Zwart | | 73981 | 73982 | 73983 | | | | | |
| Aluminium | | 73977 | 73978 | 73979 | | | | | |



10.2 MEXFORM (vervolg)

| MexForm® | Afdekkap links | Afdekkap rechts | Wangpaneel | Kantenhand heractiverebare lijn | Laminaat |
|------------------------------|---|---|--|---|---|
| |  |  |  |  |  |
| Formaat (cm) | 7x69 | 7x69 | 280x40 | 6,5x90 | 18,5x118,4 |
| Cascina grenen | 73491 | 73492 | 73493 | 73500 | 73490 |
| Monticiano eik natuur | 74159 | 74160 | 74161 | 74167 | 74158 |
| Hickory masonic natuur | 73749 | 73750 | 73751 | 73758 | 73748 |
| Orleans eik zand | 73448 | 73449 | 73450 | 73457 | 73447 |
| Bussoleno eik grijs | 74071 | 74072 | 74073 | 74079 | 74070 |
| Gladstone eik grijs | 73663 | 73664 | 73665 | 73672 | 73662 |
| Jackson den | 73534 | 73535 | 73536 | 73543 | 73533 |
| Halifax eik tabak | 73620 | 73621 | 73622 | 73629 | 73619 |
| Giaveno warm noten | 74115 | 74116 | 74117 | 74123 | 74114 |
| Urbino kasteel eik antraciet | 74203 | 74204 | 74205 | 74211 | 74202 |
| FineLine metallic | 73964 | 73965 | 73966 | 73973 | 73963 |
| Vesuvius zwart houtnerf | 74247 | 74248 | 74249 | 74255 | 74246 |
| Cefalu | 73878 | 73879 | 73880 | 73887 | 73877 |
| Licht beton | 73319 | 73320 | 73321 | 73328 | 73318 |
| Beton | 73362 | 73363 | 73364 | 73371 | 73361 |
| Leisteen | 73792 | 73793 | 73794 | 73801 | 73791 |
| Marmer | 73835 | 73836 | 73837 | 73844 | 73834 |
| Oester | | | 74004 | | |
| Platina wit | | | 73996 | | |
| Grafietgrijs | | | 73992 | | |
| Donker taupe | | | 73988 | | |
| Zwart | | | 73984 | | |
| Aluminium | | | 73980 | | |

**OOK DEALER WORDEN?**

MexForm wordt ondersteund met een aantrekkelijke display, een complete monstrekoffer waarmee je de mogelijkheden eenvoudig kunt presenteren en een mooie consumentenfolder.



Neem contact op met je vertegenwoordiger.



10.3 NATURAL WOOD

| Rustiek eiken onbehandeld | Afmeting | Enkel/dubbel | Uitsparing | Artikelnr. | |
|--|---------------------|--------------|-------------------|-------------------|-------|
|  | Traptrede | 92x57 cm | dubbel | met uitsparing | 71110 |
| | | 92x57 cm | dubbel | zonder uitsparing | 71104 |
| | | 115x57 cm | dubbel | met uitsparing | 71111 |
| | | 115x57 cm | dubbel | zonder uitsparing | 71105 |
| | | 138x57 cm | dubbel | met uitsparing | 71112 |
| | | 138x57 cm | dubbel | zonder uitsparing | 71106 |
| | Uitlooptrede | 92x28 cm | enkel | met uitsparing | 71114 |
| | | 92x28 cm | enkel | zonder uitsparing | 71107 |
| | | 138x28 cm | enkel | met uitsparing | 71115 |
| | | 138x28 cm | enkel | zonder uitsparing | 71108 |
| 210x29 cm | | enkel | met uitsparing | 71109 | |
| | 210x29 cm | enkel | zonder uitsparing | 71103 | |

| Natuur eiken onbehandeld | Afmeting | Enkel/dubbel | Uitsparing | Artikelnr. | |
|---|--|--------------|-------------------|-------------------|-------|
|  | Traptrede | 92x57 cm | dubbel | met uitsparing | 71127 |
| | | 92x57 cm | dubbel | zonder uitsparing | 71120 |
| | | 115x57 cm | dubbel | met uitsparing | 71128 |
| | | 115x57 cm | dubbel | zonder uitsparing | 71121 |
| | | 138x57 cm | dubbel | met uitsparing | 71129 |
| | | 138x57 cm | dubbel | zonder uitsparing | 71122 |
| | Uitlooptrede | 92x28 cm | enkel | met uitsparing | 71130 |
| | | 92x28 cm | enkel | zonder uitsparing | 71124 |
| | | 138x28 cm | enkel | met uitsparing | 71131 |
| | | 138x28 cm | enkel | zonder uitsparing | 71125 |
| 210x29 cm | | enkel | met uitsparing | 71126 | |
| | 210x29 cm | enkel | zonder uitsparing | 71119 | |
| Stootbord | Stootborden leveren we uitsluitend in de natuur sortering | | | | |
| | | 92x18 cm | | 71156 | |
| | | 115x18 cm | | 71157 | |
| | | 138x18 cm | | 71158 | |

| Afwerkprofielen | Afmeting/lengte | Kleur | Artikelnr. | |
|--|---|------------------------|------------|-------|
|  | Losse neuslijst | 138x6 cm | Eiken | 71173 |
| | | | | |
|  | Trapuitloopprefiel 26 mm voor losse neus | 135 cm | Zilver | 65360 |
| | | 135 cm | RVS | 65362 |
| | | 135 cm | Zwart | 65361 |
| | | 300 cm | Zilver | 65357 |
| | | 300 cm | RVS | 65359 |
| | 300 cm | Zwart | 65358 | |
|  | Hoekprofiel | 20x20 mm | Eiken | 71176 |
| | | (15x15 mm inwendig) | | |

| Fineer voor afwerking onderzijde treden en wangen | Afmeting | Artikelnr. | |
|---|----------------------------------|------------|-------|
|  | Triplex 4 mm eiken fineer | 92x57 cm | 71145 |
| | | 115x157 cm | 71146 |
| | | 138x57 cm | 71147 |
| Eiken fineer/8mm MDF afwerkstrook | 305x10 cm | 71167 | |
| Trapwangen eiken fineer/8mm MDF | 305x39,5 cm | 71168 | |

10.3 NATURAL WOOD (vervolg)





| Stootbord wit gegrond | Afmeting | Artikelnr. |
|---|-----------|------------|
|  | MDF 9 mm | |
| | 92x18 cm | 71151 |
| | 115x18 cm | 71152 |
| | 138x18 cm | 71153 |



**DUBBEL
STOOTBORD FOLIE**
Vanwege de verschillende kleur per kant,
zijn deze stootborden multi-inzetbaar
8 mm dik

| Formaat (cm) | 92x40 | 115x40 | 138x40 | 160x40 |
|-----------------|-------|--------|--------|--------|
| RAL9003/RAL9016 | 71607 | 71608 | 71609 | 71599 |
| RAL9010/RAL7043 | 71617 | 71618 | 71619 | 71598 |
| RAL9005/RAL7042 | 71627 | 71628 | 71629 | 71597 |





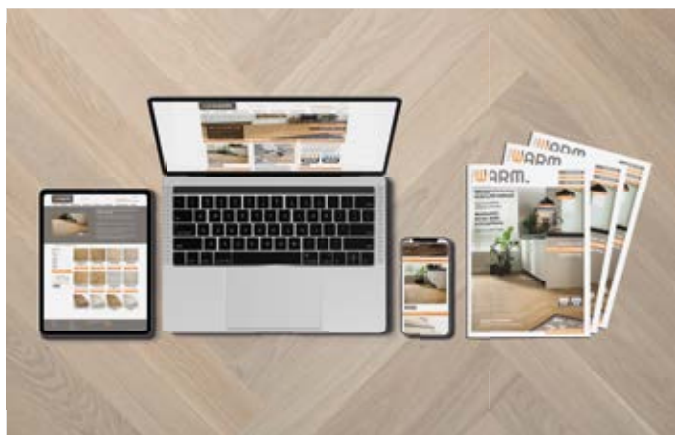









10.4 WARM BY BAUWERK



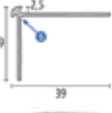







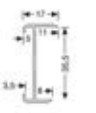

| 2-laags eiken visgraat | Afmeting | Artikelnr. |
|---|--|------------|
|  | Lengte | 140 cm |
| | Dikte | 9,5 mm |
| | Uitwendige maat | 88x52 mm |
| | Neus inwendig | 42,5 mm |
|  | Trapneusprofiel Caramel macchiato | 04530 |
|  | Trapneusprofiel Cappuccino | 04532 |
|  | Trapneusprofiel Latte macchiato | 04533 |
|  | Trapneusprofiel Caffé mocha | 04534 |

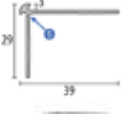
**MEER WARM BY BAUWERK**



Warm by Bauwerk biedt ook een prachtige houten vloer en collectie die uitermate geschikt is voor vloerverwarming en vloerkoeling. Natuurlijk parket, ultra mat afgelakt en in trendy kleuren. Verkrijgbaar als plankenvloer met vellingkant of chique visgraatpatroon. De 2-laags eiken visgraat trapneusprofielen caramel macchiato of cappuccino sluiten naadloos aan op de visgraatvloer van Warm. Alle mogelijkheden en de unieke voordelen van Warm by Bauwerk zijn terug te vinden in deze catalogus en op de overzichtelijke website, www.warmvloeren.nl. Tevens is er een zeer informatieve consumentenfolder met totaaloverzicht van de vloeren beschikbaar.





10.5 TRAPNEUSPROFIELEN

| PVC 2-3 mm | Lengte | Kleur | Artikelnr. |
|---|--------|------------------------|-------------------------|
|  | 300 cm | Zilver RVS Zwart | 65377 65378 65421 |
|  | 30 cm | Zilver | 65460 |
|  | 100 cm | Zilver | 65461 |
|  | 100 cm | Zilver | 65462 |
|  | | Zilver RVS Zwart | 65471 65472 65473 |
|  | | Zilver RVS Zwart | 65477 65478 65479 |
|  | | Zilver RVS Zwart | 65483 65484 65485 |
|  | 250 cm | Zilver RVS Bron | 65379 65380 65401 |
|  | 250 cm | zilver RVS brons | 65433 65434 65435 |
|  | 250 cm | Zilver RVS Bron | 65381 65382 65402 |
|  | 250 cm | Zilver RVS Bron | 65385 65386 65404 |
|  | 250 cm | Zilver RVS Bron | 65389 65390 65406 |
|  | 250 cm | Zilver RVS | 65418 65419 |
| PVC 3 mm | Lengte | Kleur | Artikelnr. |
|  | 300 cm | Zilver RVS Zwart | 65441 65440 65442 |
|  | 30 cm | Zilver | 65450 |





| PVC 3 mm | Lengte | Kleur | Artikelnr. |
|---|--|--|--|
|  | 100 cm | Zilver | 65452 |
|  | 100 cm | Zilver | 65451 |
|  | 300 cm | Zilver RVS Zwart | 65416 65417 65414 |
|  | 250 cm | Zilver RVS Bron Zwart | 65316 65356 65336 65346 |
|  | 250 cm | zilver RVS brons | 65315 65355 65335 |
|  | 250 cm | Zilver RVS Bron | 65383 65384 65403 |
|  | 250 cm | Zilver RVS Bron | 65430 65431 65432 |
| Klik PVC | Lengte | Kleur | Artikelnr. |
|  | 250 cm | Zilver RVS Bron | 65800 65802 65801 |
|  | 250 cm | Zilver | 65420 |
|  | 250 cm | Zilver RVS Bron | 65387 65388 65405 |
| Duoplank, lamelparket | Lengte | Kleur | Artikelnr. |
|  | 250 cm | Zilver RVS Bron | 65809 65811 65810 |
|  | 135 cm 135 cm 135 cm 300 cm 300 cm 300 cm | Zilver RVS Zwart Zilver RVS Zwart | 65360 65362 65361 65357 65359 65358 |

10.5 TRAPNEUSPROFIELEN (vervolg)





| Laminaat | Lengte | Kleur | Artikelnr. |
|---|--------|---------------|------------|
|  | 250 cm | Zilver | 65803 |
| | | RVS | 65805 |
| | | Brons | 65804 |
|  | 250 cm | Zilver | 65806 |
| | | RVS | 65808 |
| | | Brons | 65807 |
|  | 300 cm | Zilver geb. | 65312 |
| | | RVS look geb. | 65313 |
| | | Zwart | 65314 |

| Universeel | Lengte | Kleur | Artikelnr. |
|---|--------|--------|------------|
|  | 90 cm | Zilver | 66715 |
| | | Goud | 66725 |
|  | 300 cm | Zilver | 65368 |
| | | RVS | 65370 |
| | | Brons | 65369 |
|  | 300 cm | Zilver | 65365 |
| | | RVS | 65366 |
| | | Brons | 65367 |
|  | 300 cm | Zilver | 65371 |
| | | RVS | 65372 |
| | | Brons | 65373 |
|  | 300 cm | Zilver | 65374 |
| | | RVS | 65376 |
| | | Brons | 65375 |





| Trapneusprofiel inleg | Lengte | Kleur | Artikelnr. |
|---|--------|--------|------------|
|  | 250 cm | Zilver | 65115 |
| | | RVS | 65155 |
| | | Brons | 65135 |
| | | Goud | 65125 |
| | | Zand | 65145 |



| Inleg voor trapneusprofiel | Lengte | Kleur | Artikelnr. |
|---|--------|---------------|------------|
|  | 250 cm | Antraciet | 65212 |
|  | 250 cm | Fluorescerend | 65311 |
|  | 250 cm | Grijs | 65313 |
|  | 250 cm | Zwart | 65211 |

10.6 ANTISLIP

| Antislip | kleur/materiaal | Artikelnr. |
|---|-----------------|------------|
|  | Zwart | 71232 |
| | Grijs | 71233 |
| | Bruin | 71234 |
| | Wit | 71235 |
| | Aluminium kleur | 71236 |
|  | Zwart | 94286 |
| | Bruin | 94287 |
|  | RVS geborsteld | 71238 |
| | RVS geborsteld | 71239 |
|  | Zwart | 71225 |
| | Grijs | 71227 |
| | Wit | 71229 |
|  | Zwart | 71226 |
| | Grijs | 71228 |
| | Wit | 71230 |

10.7 TRAPLEUNINGEN EN LEUNINGHOUDERS



| Dicht metaal | Lengte | Artikelnr. |
|--|--|------------|
|  | Trapleuning RVS geborsteld rond Ø45 | |
| | 50 cm | 70714 |
| | 60 cm | 70715 |
| | 70 cm | 70716 |
| | 80 cm | 70717 |
| | 90 cm | 70718 |
| | 100 cm | 70750 |
| | 120 cm | 70751 |
| | 150 cm | 70752 |
| | 175 cm | 70719 |
| | 200 cm | 70753 |
| | 250 cm | 70754 |
| | 270 cm | 70755 |
| | 300 cm | 70756 |
| | 350 cm | 70757 |
|  | Trapleuning RVS geborsteld blind rond Ø45 | |
| | 50 cm | 70720 |
| | 60 cm | 70721 |
| | 70 cm | 70722 |
| | 80 cm | 70723 |
| | 90 cm | 70724 |
| | 100 cm | 70759 |
| | 120 cm | 70760 |
| | 150 cm | 70761 |
| | 175 cm | 70725 |
| | 200 cm | 70762 |
| | 250 cm | 70763 |
| | 270 cm | 70764 |
| | 300 cm | 70765 |
| | 350 cm | 70766 |
|  | Trapleuning zwart rond Ø45 | |
| | 50 cm | 70670 |
| | 60 cm | 70671 |
| | 70 cm | 70672 |
| | 80 cm | 70673 |
| | 90 cm | 70674 |
| | 100 cm | 70675 |
| | 120 cm | 70676 |
| | 150 cm | 70677 |
| | 175 cm | 70678 |
| | 200 cm | 70679 |
| | 250 cm | 70680 |
| | 270 cm | 70681 |
| | *300 cm | 70682 |
| | *350 cm | 70683 |
|  | Trapleuning blind zwart rond Ø45 | |
| | 50 cm | 70649 |
| | 60 cm | 70650 |
| | 70 cm | 70651 |
| | 80 cm | 70652 |
| | 90 cm | 70653 |
| | 100 cm | 70654 |
| | 120 cm | 70655 |
| | 150 cm | 70656 |
| | 175 cm | 70657 |
| | 200 cm | 70658 |
| | 250 cm | 70659 |
| | 270 cm | 70660 |
| | *300 cm | 70661 |
| | *350 cm | 70662 |

| Dicht metaal | Lengte | Artikelnr. |
|---|------------------------------------|------------|
|  | Trapleuning RVS geborstelde | |
| | 50 cm | 70738 |
| | 60 cm | 70739 |
| | 70 cm | 70740 |
| | 80 cm | 70741 |
| | 90 cm | 70742 |
| | 100 cm | 70786 |
| | 120 cm | 70787 |
| | 150 cm | 70788 |
| | 175 cm | 70743 |
| | 200 cm | 70789 |
| | 250 cm | 70790 |
| | 270 cm | 70791 |
| | 300 cm | 70792 |
| | 350 cm | 70793 |
|  | Trapleuning Zwart | |
| | 50 cm | 70628 |
| | 60 cm | 70629 |
| | 70 cm | 70630 |
| | 80 cm | 70631 |
| | 90 cm | 70632 |
| | 100 cm | 70633 |
| | 120 cm | 70796 |
| | 150 cm | 70635 |
| | 175 cm | 70636 |
| | 200 cm | 70637 |
| | 250 cm | 70638 |
| | 270 cm | 70639 |
| | *300 cm | 70640 |
| | *350 cm | 70641 |





* In verband met lengtebeperking in de coatingstraat worden zwarte leuning langer dan 270 cm gemaakt uit twee stukken. Deze 2 delen worden bij de montage in elkaar geschoven. Er is in het midden van de leuning een klein naadje zichtbaar.

| Leuninghouder voor metalen leuning | Artikelnr. |
|---|------------|
|  Trapleuninghouder zwart | 70669 |
|  Trapleuninghouder geborsteld RVS (2 stuks) | 70758 |
|  Trapleuninghouder voor blinde montage geborsteld RVS | 70767 |
|  Trapleuninghouder voor blinde montage zwart | 70648 |
|  Trapleuninghouder plat zwart | 70627 |

10.7 TRAPLEUNINGEN EN LEUNINGHOUDERS (vervolg)

| Afgerond hout | Lengte | Artikelnr. |
|---|---|--------------|
|  | Trapleuning eiken onbehandeld rond Ø40 | 100 cm 70831 |
| | | 120 cm 70832 |
| | | 180 cm 70833 |
| | | 250 cm 70834 |
| | | 300 cm 70835 |
| | 350 cm 70836 | |
|  | Trapleuning wit gegrond rond Ø40 | 100 cm 70825 |
| | | 120 cm 70826 |
| | | 180 cm 70827 |
| | | 250 cm 70828 |
| | | 300 cm 70829 |
| | 350 cm 70830 | |

| Leuninghouder hol/rond voor houten leuning | Montage | Artikelnr. |
|---|---|---|
|  | Leuninghouder hol modern aluminium | Beton/steen 70872 hout/gipsplaat 70877 |
| | Leuninghouder hol modern zwart | Beton/steen 70873 hout/gipsplaat 70878 |
|  | Leuninghouder hol klassiek aluminium | Beton/steen 70870 hout/gipsplaat 70875 |
| | Leuninghouder hol klassiek zwart | Beton/steen 70871 hout/gipsplaat 70876 |
|  | Leuninghouder hol RVS | Beton/steen 70874 hout/gipsplaat 70879 |

| Stomp | Lengte | Artikelnr. |
|---|--|--------------|
|  | Trapleuning eik onbehandeld sleutelgat 40x60 mm | 100 cm 70849 |
| | | 120 cm 70850 |
| | | 180 cm 70851 |
| | | 250 cm 70852 |
| | | 300 cm 70853 |
| | 350 cm 70854 | |
|  | Trapleuning wit gegrond sleutelgat 40x60 mm | 100 cm 70855 |
| | | 120 cm 70856 |
| | | 180 cm 70857 |
| | | 250 cm 70858 |
| | | 300 cm 70859 |
| | 350 cm 70860 | |
|  | Trapleuning eiken onbehandeld modern 50x65 mm | 100 cm 70837 |
| | | 120 cm 70838 |
| | | 180 cm 70839 |
| | | 250 cm 70840 |
| | | 300 cm 70841 |
| | 350 cm 70842 | |
|  | Trapleuning eiken onbehandeld 40x30 mm | 100 cm 70843 |
| | | 120 cm 70844 |
| | | 180 cm 70845 |
| | | 250 cm 70846 |
| | | 300 cm 70847 |
| | 350 cm 70848 | |

| Leuninghouder vlak/plat voor houten leuning | Montage | Artikelnr. |
|---|--|---|
|  | Leuninghouder vlak modern aluminium | Beton/steen 70882 hout/gipsplaat 70887 |
| | Leuninghouder vlak modern zwart | Beton/steen 70883 hout/gipsplaat 70888 |
|  | Leuninghouder vlak klassiek aluminium | Beton/steen 70880 hout/gipsplaat 70885 |
| | Leuninghouder vlak klassiek aluminium | Beton/steen 70881 hout/gipsplaat 70886 |
|  | Leuninghouder vlak RVS | Beton/steen 70884 hout/gipsplaat 70889 |

10.8 GEREEDSCHAPPEN

| Kitten | Kleur | Inhoud | Artikelnr. |
|---|---|--------------|------------------------------|
|  | Soudal traptredenmontagekit Purocol Express 1K PU | Transparant | 290 ml 96833 |
|  | Soudal PU construct XF snelle uitharding | Beige | 310 ml 84054 |
|  | Soudaseal Supertack montagekit | Wit | 290 ml 96834 |
|  | Soudal Acryrub acrylkit | Wit Zwart | 310 ml 96840 310 ml 96841 |
|  | Plinten & Profielen kit | Wit | 310 ml 96830 |
|  | Stauf Repacoll S 1K SPU montagekit | Wit | 310 ml 96459 |

TIP!

KITTEN OP KLEUR

Bijpassende kleuren voor het afkitten van de trap vind je in hoofdstuk 3: Lijmen & Kit > 3.8 Kitten op kleur of kijk in onze webshop















| Gereedschap | Artikelnr. |
|---|--|
|  | Snelspan lijmkleem 30x6,5 cm 85433 |
|  | Accu-Invalcirkelzaagmachine TSC55 KEB-Basic 88287 |
|  | Accu-Invalcirkelzaagmachine TSC55 KEBI-Plus/XL 88288 |
|  | Invalcirkelzaagmachine TS 55 FEBQ-Plus-FS 88286 |
|  | Invalcirkelzaagmachine TS 75 EBQ-Plus-FS 87521 |
|  | Trek-/afkortzaag CS 70 EBG-Set 87557 |
|  | Trek-/afkortzaag CS 70 EBG 87563 |

TIP!

Meer gereedschappen zijn te vinden in hoofdstuk 9: Gereedschap of kijk in onze webshop

| Gereedschap | Artikelnr. |
|---|---|
|  | Kitpistool professioneel 84192 |
|  | Kaartjes voor uitmeten trapwag (100 stuks) 140x280 mm 70902 80x140 mm 70903 |
|  | Trapkant hoekafschrijver 85314 |
|  | Professionele trapspin 85315 |
|  | Professioneel trapsjabloon 85316 |
|  | Zuignap aluminium 35 kg 85309 |
|  | Zuignap zwart Ø 11,5 mm 85308 |

10.8 FOLDERS EN DISPLAYS

| Trenovo | | Artikelnr. |
|---|--|------------|
|  | Trenovo monsterkoffer | 70992 |
|  | Trenovo open trap staal | 70991 |
|  | Display toren inclusief LED-verlichting | 70993 |
|  | Trenovo display XL | 70939 |
|  | Brochure Trenovo traprenovatie | 70995 |
| MexForm | | Artikelnr. |
|  | MexForm traprenovatie monsterkoffer | 73249 |
|  | MexForm traprenovatie display | 73238 |
|  | MexForm consumenten brochure | 73247 |
| Natural Wood | | Artikelnr. |
|  | Natural Wood traprenovatie display | 71097 |
|  | Natural Wood traprenovatie monsterkoffer | 71095 |
| Trapleuningen | | Artikelnr. |
|  | Monsterpakket trapleuningen | 71098 |
|  | Trapleuningen display | 71096 |
| Trapneusprofielen | | Artikelnr. |
|  | Monsterwaaier trapneusprofielen | 99942 |
|  | Display traprenovatie profielen | 99988 |
|  | Mini display traprenovatie profielen | 99913 |

OOK DEALER WORDEN?

Trenovo en MexForm worden ondersteund met een aantrekkelijke display, een complete monsterkoffer waarmee je de mogelijkheden eenvoudig kunt presenteren en een mooie consumentenfolder. Neem contact op met je vertegenwoordiger.





TRAPRENOVATIE BESTELTOOL

**BESTEL IN EEN
HANDOMDRAAI EEN
COMPLETE TRAP!**

Met de traprenovatie besteltool bestel je in een handomdraai een complete trap. In deze tool kan je **kiezen uit onze drie traprenovatie merken: Trenovo, MexForm en Natural Wood**. Van elk merk staan alle producten bij elkaar in deze overzichtelijke tool. In drie makkelijke stappen maak je eenvoudig een bestellijst met de producten die je nodig hebt voor je klus.

Met de traprenovatie besteltool van PPC bespaar je veel tijd! Alles voor het gemak van de parketteur en vloerenspecialist.

Maak kennis met de traprenovatie besteltool en ervaar het gemak. Scan de QR-code en begin meteen.

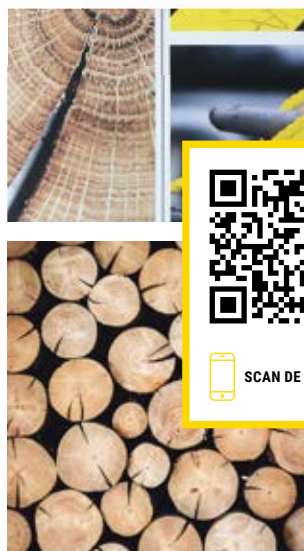
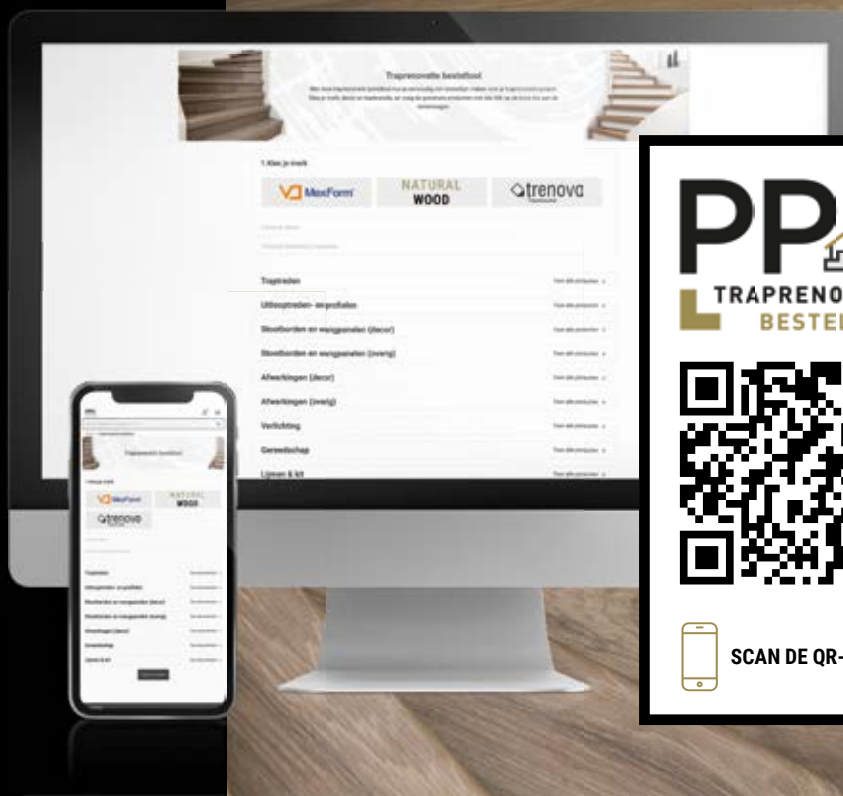

SCAN DE QR-CODE

Schrijf je in voor de basis of expert traprenovatie trainingen in de PPC Academy, hét opleidingscentrum voor de parketteur en de vloerenspecialist.

Scan de QR-code voor het actuele overzicht van alle geplande trainingen en de beschikbare inschrijfdata.

**PPC
ACADEMY**

ALLE KENNIS IN HUIS

PLINTENENPROFIELENCENTRALE.NL/ACADEMY

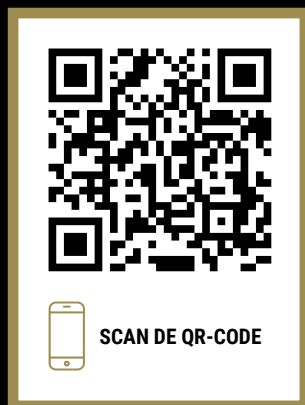

**WIJK BIJ DUURSTEDE | AMSTERDAM | DEN HAAG
EINDHOVEN | GRONINGEN | NIEUWEGEIN | BELGIË**

**WWW.PLINTENENPROFIELECENTRALE.NL
WWW.PPCBELGIUM.BE**

